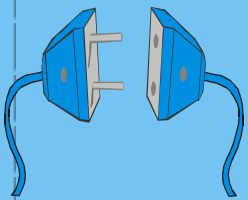




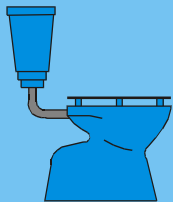
HVAC



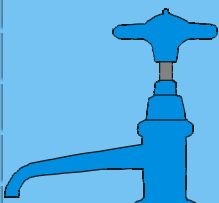
FUEL



ELECTRICAL



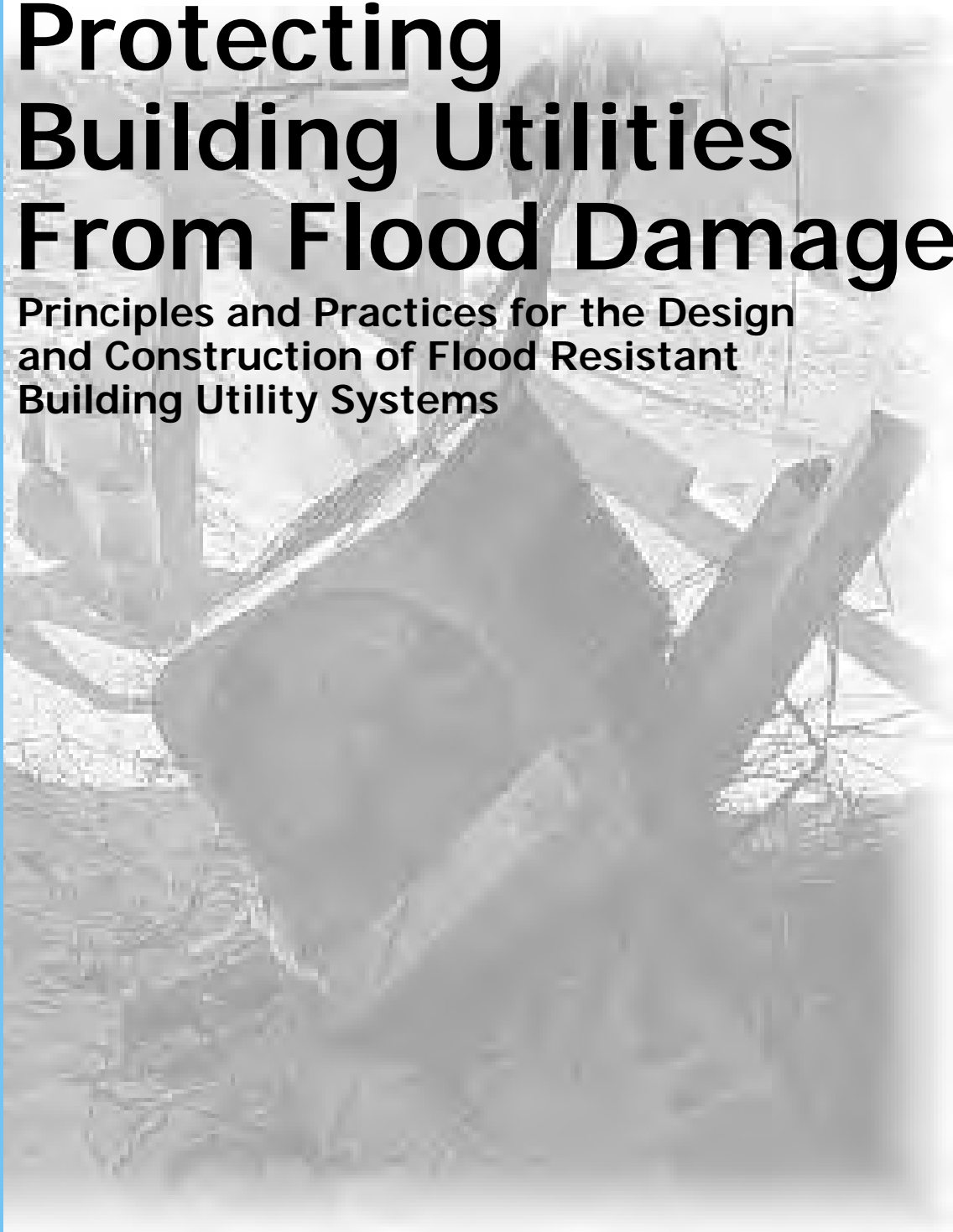
SEWAGE



WATER

# Protecting Building Utilities From Flood Damage

Principles and Practices for the Design and Construction of Flood Resistant Building Utility Systems



**FEDERAL EMERGENCY MANAGEMENT AGENCY**

Mitigation Directorate  
500 C Street, SW  
Washington, DC 20472



# IMPORTANT

If you ordered and received your copy of *Protecting Building Utilities From Flood Damage* directly from the FEMA Publications Center, you will automatically receive future updates. **If you received your copy of *Protecting Building Utilities From Flood Damage* through a source other than directly from the FEMA Publications Center, you must complete the coupon below and mail it to the Center or you will not receive future updates.**



.....  
Please add my name to the FEMA Mailing List **FE 30** and send me updates of *Protecting Building Utilities From Flood Damage*

\_\_\_\_\_  
Name

\_\_\_\_\_  
Address

\_\_\_\_\_  
City

\_\_\_\_\_  
State

\_\_\_\_\_  
Zip Code

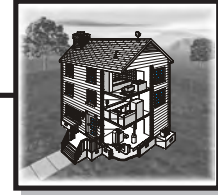
Fold .....

Place  
Postage  
Here

Federal Emergency Management Agency  
P.O. Box 2012  
Jessup, MD 20794-2012

# Table of Contents

---



<b>CONTENTS</b>	<b>Page</b>
<b>CHAPTER 1 - Introduction/Overview</b>	
1.0 Introduction	1-2
1.1 How to Use this Manual	1-3
1.2 Introduction to Hazards	1-8
1.3 Basic Protection Methods	1-13
<b>CHAPTER 2 - Regulatory Framework</b>	
2.0 Introduction	2-2
2.1 Background of the National Flood Insurance Program (NFIP)	2-2
2.2 Community Floodplain Management Permitting Process	2-5
2.3 NFIP Definitions	2-7
2.4 NFIP Requirements for Existing Buildings	2-10
2.5 NFIP Building Performance Requirements	2-12
2.6 Building Codes	2-14
2.7 National Consensus Standards	2-19
2.8 Health and Sanitary Regulations	2-20
2.9 After the Flood - Guidelines for Building Officials	2-20
<b>CHAPTER 3 - New and Substantially Improved Buildings</b>	
3.0 Introduction	3.0-2
<b>Sections</b>	
3.1 HVAC Systems	3.1-1
3.2 Fuel Systems	3.2-1
3.3 Electrical Systems	3.3-1
3.4 Sewage Management Systems	3.4-1
3.5 Potable Water Systems	3.5-1
<b>CHAPTER 4 - Existing Buildings</b>	
4.0 Introduction	4-2
4.1 Methods of Floodproofing Existing Utility Systems By Retrofitting	4-3
4.2 Field Investigation	4-4
4.3 Retrofitting Scenarios	4-8



**CONTENTS (cont'd)**

**Page**

**APPENDICES**

<b>A</b>	<b>Bibliography and Sources of Information</b>	<b>A-1</b>
<b>B</b>	<b>Glossary of Terms</b>	<b>B-1</b>
<b>C</b>	<b>FEMA Offices</b>	<b>C-1</b>
<b>D</b>	<b>NFIP State Coordinating Agencies</b>	<b>D-1</b>
<b>E</b>	<b>Professional Organizations</b>	<b>E-1</b>

### **CONTENTS**

	<b>Page</b>
<b>1.0 Introduction</b>	<b>1-2</b>
<b>1.1 How to Use this Manual</b>	<b>1-3</b>
<b>1.1.1 Organization of the Manual</b>	<b>1-3</b>
<b>1.1.2 Use of Icons</b>	<b>1-4</b>
<b>1.1.3 Metrification</b>	<b>1-7</b>
<b>1.2 Introduction to Hazards</b>	<b>1-8</b>
<b>1.2.1 Examples of Flood Damage to Building Support Utility Systems</b>	<b>1-10</b>
<b>1.3 Basic Protection Methods</b>	<b>1-13</b>
<b>1.3.1 Elevation</b>	<b>1-13</b>
<b>1.3.2 Component Protection</b>	<b>1-14</b>

### **FIGURES**

<b>Figure 1.2.1A: Electric heat pump dislocated from its shattered wooden stand by velocity flow in a coastal area</b>	<b>1-11</b>
<b>Figure 1.2.1B: Interior fuel oil tank dislocated by buoyancy forces</b>	<b>1-11</b>
<b>Figure 1.2.1C: Electrical control panel damaged by velocity flow in a coastal area</b>	<b>1-12</b>
<b>Figure 1.2.1D: The result of sewage back-up through a toilet during a riverine flooding event</b>	<b>1-12</b>

### **TABLE**

<b>Table 1.1.3: Metric conversion factors</b>	<b>1-7</b>
---	------------



### 1.0 Introduction

Floodplains are home to nearly 10 million households. In an average year, floods kill 150 people and cause over \$3 billion in property damage. National average annual flood losses continue to increase.

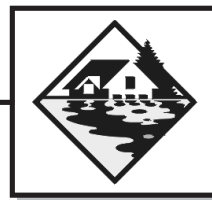
#### NOTE:

The overall objective of this document is to assist in the construction of buildings with building utility systems that are designed and built so that the buildings can be re-occupied and fully operational as soon as electricity and sewer and water are restored to the neighborhood.

A large proportion of flood damage is incurred by components of building utility systems such as furnaces, boilers, air conditioning compressors, air ducts, water supply pipes, septic tanks and sewer pipes, electric and gas meters, control panels, electrical wiring, and gas pipes. Flooding of building utility systems impacts people, communities and businesses in many ways, some of which are outlined below:

- Flood inundation can damage equipment leading to costly repair bills. The force of moving water and floating debris can destroy equipment leading to costly replacement bills.
- Inundation of electrical system components such as switches, fuse boxes, control panels, and receptacles causes short-circuits, corrosion, and possibilities for electrical shock hazards and fires.
- Inundation of fuel system components such as tanks, pipelines, and gas meters can cause flotation of tanks, corrosion, severance of pipe connections, and rupture of tanks. Floating fuel tanks in flood waters are a fire and debris impact hazard. Floodwater contaminated with fuel oil makes clean-up of flood damaged houses much more difficult and expensive.
- Flood induced damage to pipes, manholes, septic tanks, service connection pipes, and on-site wells can contaminate wastewater and water supply systems rendering otherwise habitable buildings uninhabitable and can cause hazardous waste to be released into floodwater.
- Flood induced disruption in business operations can generate productivity declines resulting in substantial economic losses.

Despite concentrated efforts of government and the private sector to mitigate flood hazards, many problems still remain with current practices, including methods of design and construction of building utilities. For that reason, this guide was prepared to illustrate the design and construction of building utility systems for residential and non-residential structures located in flood-prone areas in order to comply with the National Flood Insurance Program (NFIP) floodplain management requirements.



The intended users of this manual are developers, architects, engineers, builders, code officials and homeowners who are involved in designing and constructing building utility systems for residential and non-residential structures. This manual discusses flood protective design and construction of utility systems for new buildings and modifications to utility systems in existing buildings.

### 1.1 How to Use this Manual

#### 1.1.1 Organization of the Manual

This manual is organized into four main chapters as follows:

##### **CHAPTER 1 - Introduction/Overview**

- Introductory discussion of the background, goal, intended users, and organization of the manual
- Effects of flood hazards on building support utility systems
- Introduction to the methods of floodproofing building support utility systems

##### **CHAPTER 2 - Regulatory Framework**

- Background of the National Flood Insurance Program (NFIP)
- Discussion of community regulations and the permitting process
- NFIP floodplain management definitions
- NFIP requirements for new and existing buildings
- Model Building Codes
- Code compatibility with the NFIP
- Discussion of health and sanitary regulations

##### **CHAPTER 3 - New and Substantially Improved Buildings**

This chapter covers both new and substantially improved buildings, as defined by the NFIP. Substantially improved buildings are those that have been improved to an amount equal to 50% of their market value. Refer to Chapter 2 and Appendix B, Glossary of Terms, for the definition of the term substantially damaged.

##### **NOTE:**

New and substantially improved structures must meet the minimum requirements of the NFIP contained in the local building code and floodplain management regulations. Substantially improved buildings include those that have been substantially damaged. See your building official or floodplain administrator for more information. Chapter 3 of this manual provides guidance on how to meet the requirements for building utility systems in new and substantially improved buildings. Chapter 4 provides guidance on additional ways to protect building utility systems in existing buildings that have not been substantially improved.



- Introduction to floodproofing utility systems in new and substantially improved buildings
- Discussion of systems, hazards, methods of protection and recommended flood protection practices for:
  - Heating, Ventilating, and Air Conditioning (HVAC) Systems
  - Fuel Systems
  - Electrical Systems
  - Sewage Management Systems
  - Potable (drinking) Water Systems

### CHAPTER 4 - Existing Buildings

This chapter provides guidance on floodproofing building support utility systems for existing structures that have not been substantially damaged or improved.

- Discussion of methods of retrofitting various types of systems:
  - Heating, Ventilating, and Air Conditioning (HVAC) Systems
  - Fuel Systems
  - Electrical Systems
  - Sewage Management Systems
  - Potable (drinking) Water Systems

#### 1.1.2 Use of Icons

The following icons are used in this manual:



Note: Contains important information



Caution: Contains information related to compliance with the minimum NFIP requirements and other laws and ordinances



Meets minimum NFIP requirements and is also the recommended practice





For your reference, each of the chapters, sections within Chapter 3, and appendices are represented by the following icons:



### **Chapter 1 - Introduction/Overview**



### **Chapter 2 - Regulatory Framework**



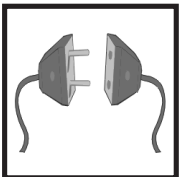
### **Chapter 3.0 - Introduction to Floodproofing Utility Systems in New and Substantially Improved Buildings**



### **Section 3.1 - Heating, Ventilating, and Air Conditioning (HVAC) Systems**



### **Section 3.2 - Fuel Systems**



### **Section 3.3 - Electrical Systems**



### **Section 3.4 - Sewage Management Systems**



**Section 3.5 - Potable Water Systems**



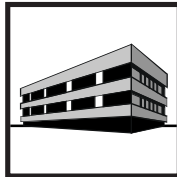
**Chapter 4 - Existing Buildings**



**Appendix A - Bibliography and Sources of Information**



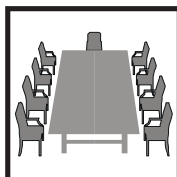
**Appendix B - Glossary of Terms**



**Appendix C - FEMA Offices**



**Appendix D - NFIP State Coordinating Agencies**



**Appendix E - Professional Organizations**



### 1.1.3 Metrification

The Federal Emergency Management Agency (FEMA) is committed to the federal government's transition to the metric system. However, in most cases English units remain the standard of practice for construction. Therefore, this manual has been prepared using English units.

However, it is foreseeable that the metric system may be the standard of measurement in this country in the future. With this in mind, soft metric conversions have been provided to promote familiarity with the metric system.

A critical component of unit conversion is rounding. Designers should check to ensure that rounding does not exceed allowable tolerances for design or fabrication.

Quantity	From English Units	To Metric Units	Multiply By
Length	foot	(m)	0.3048
	inch	(mm)	25.4
Area	square foot	m <sup>2</sup>	0.092
	acre	m <sup>2</sup>	4047
Volume	gallon	L	3.7714
	cubic foot	m <sup>3</sup>	.283
Pressure	psf	Pa	47.8803
	psi	kPa	6.8947
Power	horsepower	kW	.746
		W	746
Weight	pounds	kg	.4535
Flow	cfs	lps	28.3
Velocity	fps	mps	0.3048

**Table 1.1.3: Metric conversion factors**



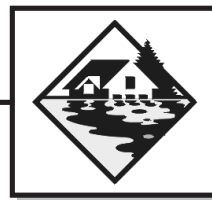
### 1.2 Introduction to Hazards

#### NOTE:

The analysis of both flood-related hazards and non-flood-related hazards is discussed in detail in Chapter IV of FEMA Publication 259 - *Engineering Principles and Practices of Retrofitting Flood-prone Residential Structures*.

Building utility systems should be designed and constructed to avoid or resist the effects of the hazards or combinations of hazards that exist in floodplains. These hazards include:

- lateral hydrostatic and buoyant forces caused by standing or slow moving water above the surface of the ground;
- hydrodynamic forces from the moderate-velocity flow or high-velocity flow of water as well as wave action;
- impact loads caused by floating debris;
- localized ponding caused by poor drainage;
- erosion and scour caused by the removal of soil and loose material by moving water as it flows over land;
- site-specific hazards, such as alluvial fans (mudslides), closed basin lakes (no outlet), and movable bed streams (erosion);
- Non-flood-related hazards such as high winds, earthquake, snow, and land subsidence. While floods continue to be a major hazard to homes nationwide, they are not the only natural hazard that causes damage to structures located in floodplains;
- site-specific soil or geotechnical considerations, such as soil pressure, bearing capacity, scour potential, shrink-swell potential, and permeability; and
- contamination caused by dissolved chemicals, silt, suspended solids, and other contaminants contained in floodwaters.



The designer of a building must be prepared to take into consideration all possible hazards that a structure could be subjected to. When designing for multiple hazards, one must ensure that the design for one hazard does not negatively impact on a building support utility system's ability to resist damages from other hazards.

Multiple hazards can occur under two hazard scenarios, as shown below.

- **Hazards that have low risk of occurring simultaneously.** As an example, there is little risk of riverine flooding occurring simultaneously with an earthquake. Most would consider it unreasonable to design for this combined hazard scenario.
- **Hazards that have a high risk of occurring simultaneously.** As an example, hurricanes induce both high winds and flooding. In coastal areas, most would consider it reasonable to design for this combined hazard scenario.

With minor modification, protection of system components from flooding can increase the components' ability to resist other damaging forces. For example, the flood protection of fuel tanks that must be located below the Design Flood Elevation (DFE) to resist lateral and vertical (buoyancy) flood forces also improve the tank's ability to resist forces from high winds and earthquakes.

However, if a system is elevated above expected flood levels, it may leave the system exposed to an increased threat of damage from high winds and earthquakes. As a result, building support utility systems elevated on support structures such as platforms, pedestals, posts, and piers, may be exposed to increased forces. These increased forces may result in toppling of components of building support utility systems or collapse of their support structures if the protection measures are not properly designed.

There are often simple solutions to address different design concerns. For example, structures used to elevate building support systems can be properly strengthened to resist increased wind and seismic loads through the simple addition of cross-bracing.

### NOTE:

The Design Flood Elevation (DFE) is a regulatory flood elevation adopted by a community that is the BFE, at a minimum, and may include freeboard as adopted by the community.



Some building codes address the structural loads from natural hazards in detail. The multi-hazard design of a building's utility system is not addressed in as much detail. In those cases where significant threats from multiple hazards are known to exist, professional engineers and/or architects as well as local building officials and floodplain administrators should be consulted.

### **1.2.1 Examples of Flood Damage to Building Support Utility Systems**

Flood water often contains dissolved chemicals, silt, suspended solids, and floating debris. Moving flood water exerts pressure on everything in its path, and causes erosion of soil and scour around solid objects. In coastal areas, breaking waves with floating debris can cause extensive physical damage. With such destructive characteristics, flood waters present many hazards to the often fragile components of building support utility systems.

The photographs presented on the following pages show examples of flood damage to building support utility systems.



**HVAC:** Improperly designed and installed furnaces, boilers, water heaters, air ducts and other indoor equipment, as well as compressors, heat pumps and other outdoor equipment are often inundated by flood waters. Flood waters can cause corrosion and contamination by silt deposits, short-circuit of electronic and electrical equipment, and other physical damage.

**Figure 1.2.1A:**  
Electric heat pump  
dislocated from its  
shattered wooden  
stand by velocity  
flow in a coastal  
area



**Fuel Systems:** Inundation of improperly designed and installed fuel system components such as tanks, pipelines, valves, regulators and gas meters can cause flotation and rupture of tanks, corrosion and short-circuit of electronic components, and severance of pipe connections. In extreme cases, damage to fuel systems can lead to fires.

**Figure 1.2.1B:**  
Interior fuel oil  
tank dislocated by  
buoyancy forces







**Electrical Systems:** Inundation of improperly designed and installed electrical system components such as switches, electric panel board, and receptacles causes short-circuit, corrosion, and possibilities for electrical shock hazards. In velocity flow areas, electrical panels can be torn off their attachments by the force of breaking waves or floating debris impact.

**Figure 1.2.1C:**  
Electrical panel board damaged by velocity flow in a coastal area

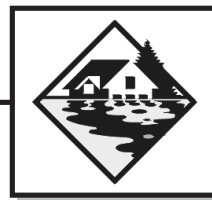


**Wastewater and Water Supply Systems:** Improperly designed and installed pipes, manholes, septic tanks, service connection pipes, and on-site water wells can be exposed by erosion and scour caused by floodwaters with velocity flow. Inundation can also cause tanks to float. Sewage backup can occur even without the structure flooding.

**Figure 1.2.1D:**  
The result of sewage back-up through a toilet during a riverine flooding event







### 1.3 Basic Protection Methods

Building utility systems can be protected from flood damage. The minimum requirements of the NFIP are as follows:

*The community must “review all permit applications to determine whether proposed building sites will be reasonably safe from flooding. If a proposed building site is in a flood-prone area, all new construction and substantial improvements shall (i) be designed (or modified) and adequately anchored to prevent flotation, collapse, or lateral movement of the structure resulting from hydrodynamic and hydrostatic loads, including the effects of buoyancy, (ii) be constructed with materials resistant to flood damage, (iii) be constructed by methods and practices that minimize flood damages, and (iv) be constructed with electrical heating, ventilation, plumbing, and air conditioning equipment and other service facilities that are designed and/or located so as to prevent water from entering or accumulating within the components during conditions of flooding.” [44CFR60.3(a)(3)]*

The primary protection methods that apply to residential and non-residential building utilities in order to meet the minimum requirements of the NFIP include elevation or component protection in place.

The developer, architect, engineer, builder, or code official must recognize that designing a new or existing building support utility system to eliminate or minimize flood damage also influences how that utility system will react to hazards other than those associated with floodwaters.

#### 1.3.1 Elevation

Elevation refers to the location of a component and/or utility system above the DFE.

Elevation is highly recommended for all utility system components in new and substantially improved structures except where the component needs to extend below the DFE for service connection or code compliance. Specific NFIP criteria for utilities will be discussed in detail in the subsequent chapters.

For new and substantially improved structures located in A Zones, the NFIP requires that the lowest floor be above the DFE. In new and substantially improved structures located in V Zones, the NFIP requires that the lowest horizontal structural member of the lowest floor be above the DFE. Non-residential buildings may also be dry floodproofed to the DFE. When the

#### NOTE:

**Substantial Improvement:**  
Any reconstruction, rehabilitation, addition, or other improvement of a structure, the cost of which equals or exceeds 50 percent of the value of the structure before the “start of construction” of the improvement. This term includes structures which have incurred “substantial damage,” regardless of the actual repair work performed. The term does not, however, include either:

- 1.) Any project for improvement of a structure to correct existing violations of state or local health, sanitary, or safety code specifications which have been identified by the local code enforcement official and which are the minimum necessary to assure safe living conditions, or
- 2.) Any alteration of a “historic structure” provided that the alteration will not preclude the structure’s continued designation as a “historic structure.”



lowest floor or horizontal structural member of the lowest floor in a structure is located above the DFE, utility system components can be protected from flood damage by locating them anywhere on, or above, the lowest floor of the structure.

If the lowest floor is above the DFE, it is also possible to achieve elevation by hanging utility system components, such as pipes and ducts, from the bottom of the lowest floor as long as the bottom of every component is above the DFE.

In existing structures, elevation can be achieved by relocating utility system components to locations above the DFE such as utility sheds and closets as well as in the attic space.

### 1.3.2 Component Protection

Component protection refers to the implementation of design techniques that protect a component or group of components from flood damage when they are located below the DFE. Component protection is sometimes referred to as *floodproofing*, especially in retrofitting existing structures. Floodproofing is further broken down into wet and dry floodproofing.

Wet floodproofing refers to the elimination or minimization of the potential of flood damage by implementing waterproofing techniques designed to keep floodwaters away from utility equipment within areas that are generally expected to be inundated with floodwaters. Wet floodproofing is covered within this manual.

Dry floodproofing refers to the elimination or minimization of the potential for flood damage by implementing a combination of waterproofing features designed to keep floodwaters completely outside of a structure. Dry floodproofing within SFHAs is prohibited by the NFIP for all new and substantially improved structures, except for non-residential structures located in A Zones.

Utility system components within a dry floodproofed structure are protected since they are not likely to come in contact with floodwaters. Since dry floodproofing applies to building protection, it will not be considered further in this publication. The specific design techniques for dry floodproofing existing residential structures are described in detail in FEMA Publication 259 - *Engineering Principles and Practices for Retrofitting Flood-prone Residential Buildings*, and for non-residential building in FEMA Publication 102 - *Floodproofing non-Residential Structures*.

## CONTENTS

	Page
2.0 Introduction	2-2
2.1 Background of the National Flood Insurance Program (NFIP)	2-2
2.2 Community Floodplain Management Permitting Process	2-5
2.3 NFIP Definitions	2-7
2.3.1 Flood Hazard Zones Shown on Flood Insurance Rate Maps (FIRMs)	2-7
2.3.2 NFIP Floodplain Management Definitions	2-8
2.4 NFIP Requirements for Existing Buildings	2-10
2.5 NFIP Building Performance Requirements	2-12
2.6 Building Codes	2-14
2.6.1 Model Building Codes	2-15
2.7 National Consensus Standards	2-19
2.8 Health and Sanitary Regulations	2-20
2.9 After the Flood - Guidelines for Building Officials	2-20
2.9.1 <i>Guidelines for Handling Water Damaged Electrical Equipment, by the National Electrical Manufacturers Association (NEMA)</i>	2-21
2.9.2 <i>Sonoma County, California, Flood 1997 - Electrical Requirements</i>	2-30

## TABLE

Table 2.6.1: Model code groups & associated model codes	2-16
---	------



Communities often adopt floodplain regulations that exceed the NFIP minimum requirements. More restrictive local codes and ordinances supersede the minimum requirements of the NFIP discussed in this manual. This section will examine only the minimum NFIP requirements governing construction in a Special Flood Hazard Area. Local building codes and construction criteria vary widely across the country. The reader must contact the local permit office to determine what floodplain management & building code requirements are in place.

## 2.0 Introduction

This chapter discusses the National Flood Insurance Program (NFIP) floodplain management requirements that apply within regulatory floodplains. A regulatory floodplain, established through the NFIP, is known as a Special Flood Hazard Area (SFHA). Communities have the primary responsibility for regulating development and construction in floodplains and do so through a range of techniques that can include land use plans and policies, zoning, subdivision, and sanitary ordinances, single purpose floodplain management ordinances, and building codes and standards.

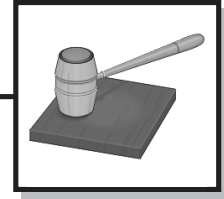
Communities that participate in the NFIP must adopt and enforce floodplain management requirements that meet or exceed minimum criteria established by the Federal Emergency Management Agency (FEMA), which administers the program. Communities meet this requirement by either adopting a single purpose floodplain management ordinance or by incorporating NFIP floodplain management requirements into their other land use measures and building codes. Many States and communities have adopted floodplain management requirements that go beyond NFIP minimum criteria.

This chapter discusses the community floodplain management requirements and building code provisions that apply to development in floodplains, including building utility systems. Topics that are covered include:

- background of the NFIP;
- the community permitting process;
- NFIP floodplain management requirements;
- building codes; and
- health and sanitary regulations;

### 2.1 Background of the National Flood Insurance Program (NFIP)

In 1968, the United States Congress passed and the President signed into law the National Flood Insurance Act, which created the NFIP. The NFIP is a



Federal Program enabling property owners to purchase insurance protection against losses from flooding. Participation in the NFIP is based on an agreement between local communities and the Federal Government which states that if a community will adopt and enforce a floodplain management ordinance to reduce future flood risks to new and substantially improved structures in Special Flood Hazard Areas (SFHAs), the Federal Government will make flood insurance available within the community as a financial protection against flood losses.

FEMA publishes maps designating SFHAs and the degree of risk in those areas. The SFHA in each community is identified on a Flood Hazard Boundary Map (FHBM) or Flood Insurance Rate Map (FIRM) prepared by FEMA. The limits of the SFHA are based on the area inundated during the Base Flood (a flood having a one percent chance of being equaled or exceeded in any given year; also referred to as a 100-year flood). Commonly accepted computer models that estimate both hydrologic and hydraulic conditions are used by FEMA to determine the Base Flood Elevation (BFE). Floodplain areas within the SFHA are either mapped as A zones or V zones.

V zones (Zones VE, VI-30, V), also known as Coastal High Hazard Areas, are mapped along the nation's coastlines. V zones, which include high velocity flows, breaking waves, and often debris, contain severe risks that present special challenges in ensuring that new development does not result in increased flood damages. NFIP regulations contain specific elevation and structural performance requirements for buildings constructed in V zones. Included are the requirements that natural features, which act to reduce flooding, such as frontal sand dunes and mangrove stands, are not altered.

All other areas within the SFHA are identified on FIRMs with one of the A zone designations (AE, AR, A1-30, AO, AH, or A). This includes riverine and lacustrine (lake) floodplains and coastal floodplains landward of V zones. A special risk area identified within A zones in riverine areas is the *floodway*. The floodway is an area identified on a FIRM or a Flood Boundary Floodway Map (FBFM) that represents the portion of the floodplain that carries the majority of the flood flow and often is associated with high velocity flows and debris impact. As with V zones, floodways often represent severe risks that present special challenges for local officials. Any new development in floodways must not obstruct flood waters or increase the BFE.



Flood insurance coverage is available to all owners and occupants of insurable property (a building and/or its contents) in a community participating in the NFIP. Almost every type of walled and roofed building that is principally above ground and not entirely over water may be insured if it is located in a participating community. To encourage participation in the NFIP by communities and the purchase of flood insurance by individuals, insurance premiums for buildings constructed prior to the issuance of a FIRM (referred to as pre-FIRM) are subsidized. Buildings constructed after the date of the FIRM (referred to as Post-FIRM) are rated based on their risk of flooding.

### NOTE:

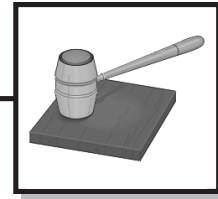
Unless superseded by more restrictive local requirements, the minimum NFIP requirements affect existing pre-FIRM buildings only when an existing building is substantially damaged or substantially improved.

Communities administer the floodplain management requirements of the NFIP. A “Community” is a governmental body with the statutory authority to enact and enforce zoning, building codes, subdivision, and other land use control measures. The authority of each unit of government varies by state. Eligible communities can include cities, villages, towns, townships, counties, parishes, states, and Indian tribes. When the community chooses to join the NFIP, it must adopt and enforce floodplain management requirements that meet or exceed the minimum requirements of the NFIP. The floodplain management requirements within the SFHA are designed to prevent new development from increasing the flood threat and to protect new and pre-FIRM buildings from anticipated flood events. A participating community in the NFIP must also require permits for all development in the SFHA and ensure that construction methods used will minimize future flood damages, including building support utility systems.

Many States and communities have adopted more restrictive requirements than those established by the NFIP based on their knowledge of local conditions and in the interest of increased safety. The most common of these are provided below:

- Adoption of floodplain management requirements that exceed the NFIP minimum standards by requiring new or substantially improved buildings to be elevated or floodproofed to one or more feet above the BFE. This more restrictive requirement is generally referred to as “freeboard” and provides an extra measure of flood protection above the design flood elevation to account for waves, debris impacts, hydraulic surge, or insufficient data.
- Counting improvements or repairs cumulatively over a specified period of time for determining if a building is being substantially improved or is substantially damaged so that it will be brought into compliance with local flood protection requirements.





- Adoption of land use requirements that prohibit specified buildings or uses in certain areas, such as the floodplain, conservation zones, and/or the floodway.
- Prohibiting the use of building materials and practices that have previously proven ineffective during flooding.

### 2.2 Community Floodplain Management Permitting Process

To participate in the NFIP, communities must regulate all development in the designated SFHA in accordance with the NFIP criteria and any applicable State and community floodplain management ordinances and/or laws. To do this, communities must require a floodplain development permit before any development proceeds in the designated SFHA of the community. “Development” means any man-made change to improved or unimproved real estate, including, but not limited to, buildings or other structures, mining, dredging, filling, grading, paving, excavation or drilling operations or storage of equipment or materials. Before the permit is issued, the community must ensure that the minimum NFIP requirements are met for development in the SFHA. This includes ensuring the building support utility systems are designed and installed in accordance with all applicable laws and ordinances. Often applicable laws and ordinances include building, fire, mechanical, and electrical codes, as well as floodplain management laws and/or ordinances.

Community floodplain management ordinances and/or laws are often incorporated into the community’s building code, zoning or subdivision ordinance and/or law, or possibly as a separate ordinance or law. Where, within the community’s laws and/or ordinances, floodplain management requirements reside will often indicate which community official is responsible for enforcing the community’s floodplain management requirements. The responsible community official is often the Building Official, Zoning Administrator, Floodplain Management Official or Municipal Engineer.

In addition, the community must review proposed development to assure that all necessary permits have been obtained from those governmental agencies from which Federal, State, or community laws or regulations require approval. It is the community’s responsibility to ensure that all applicable Federal, State, or local permits are obtained before construction work begins on the selected mitigation measure.

#### **NOTE:**

Before committing a significant investment of time and money in developing a flood protection strategy for building utility systems, contact the local permit office for information on building code, floodplain management, health and safety, or other requirements that apply and on how to obtain necessary permits.

#### **NOTE:**

The lowest floor elevation for a substantially improved or new building must be located to or above the DFE in Zone A areas. In Zone V areas, the elevation of the bottom of the lowest structural member of the lowest floor must be above the DFE.



### NOTE:

In V Zones, a registered professional engineer or architect must certify that the design is in accordance with, at a minimum, the V Zone requirements of the NFIP as specified in 44 CFR 60.6(e).



Dry floodproofing is only permitted for non-residential structures located in A Zones.

### NOTE:

More information on dry floodproofing non-residential buildings can be found in FEMA's NFIP Technical Bulletin #3, *Non-Residential Floodproofing - Requirements and Certification*.

For new construction and substantial improvement of buildings and other structures in a SFHA, the permit or accompanying documentation must indicate the elevation to which the building and the building support utility systems are to be elevated or otherwise appropriately protected from flood damage. The Design Flood Elevation (DFE) is a regulatory flood elevation adopted by a community that is the BFE, at a minimum, and may include freeboard, as adopted by the community.

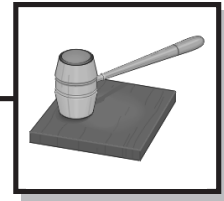
Under the NFIP, the community is responsible for ensuring that the elevation and protection of building support utility systems of new and substantially improved buildings and other structures in a SFHA are built in accordance with permit requirements, approved plans and with all applicable laws and ordinances.

Additionally, the NFIP requires the community to obtain sufficient information such as the elevation of the lowest floor (including basement) and building support utilities of all new or substantially improved buildings located in A and V zones. This is done to ensure that new construction and substantial improvements meet the minimum requirements of the NFIP and the community's floodplain management requirements.

For non-residential buildings that are dry floodproofed, the community permit official must obtain and verify the elevation to which the building is floodproofed. In addition, a registered professional engineer or architect must certify that the design and methods of construction are in accordance with accepted standards of practice for meeting the following requirements: 1) the building is watertight with walls substantially impermeable to the passage of water; 2) the attendant utility and sanitary facilities are located above the BFE, enclosed within the building's watertight walls, or made watertight and capable of resisting damage during flood conditions; and 3) the structural components have the capability of resisting hydrostatic and hydrodynamic loads and effects of buoyancy. The community permit official must obtain and maintain a copy of the floodproofing certification.

Some communities require that a new or substantially improved building cannot be used or occupied without some type of use permit or "certificate of occupancy". The official will not normally issue a use or occupancy permit until the building passes a final inspection which includes meeting applicable floodplain management requirements.





### 2.3 NFIP Definitions

#### 2.3.1 Flood Hazard Zones Shown on Flood Insurance Rate Maps (FIRMs)

The **Flood Insurance Rate Map** (FIRM) for each community identifies various zones of flooding. The six types of A Zones and the three types of V Zones described below compose the **Special Flood Hazard Area** (SFHA). The SFHA is the minimum area over which NFIP-participating communities must enforce their NFIP-compliant floodplain management requirements. The zones, shown on a FIRM, that compose the SFHA include:

- A:** Area of special flood hazard without water surface elevations determined.
- A1-30, AE:** Area of special flood hazard with water surface elevations determined.
- AO:** Area of special flood hazards having shallow water depths and/or unpredictable flow paths between (1) and (3) ft.
- A99:** Area of special flood hazard where enough progress has been made on a protective system, such as dikes, dams, and levees, to consider it complete for insurance rating purposes.
- AH:** Areas of special flood hazards having shallow water depths and/or unpredictable flow paths between (1) and (3) feet, and with water surface elevations determined.
- AR:** Area of special flood hazard that results from the decertification of a previously accredited flood protection system that is determined to be in the process of being restored to provide a 100-year or greater level of flood protection.
- V:** Area of special flood hazard without water surface elevations determined, and with velocity, that is inundated by tidal floods (coastal high hazard area).
- V1-30, VE:** Area of special flood hazards, with water surface elevations determined and with velocity, that is inundated by tidal floods (coastal high hazard area).
- VO:** Area of special flood hazards having shallow water depths and/or unpredictable flow paths between (1) and (3) ft. and with velocity.
- B, X:** Area of moderate flood hazards.



- C, X:** Area of minimal hazards.
- D:** Area of undetermined but possible, flood hazards.
- M:** Area of special mudslide (i.e., mudflow) hazards.
- N:** Area of moderate mudslide (i.e., mudflow) hazards.
- P:** Area of undetermined, but possible, mudslide hazards.
- E:** Area of special flood-related erosion hazards.

### 2.3.2 NFIP Floodplain Management Definitions

In conjunction with the adoption of minimum NFIP floodplain management provisions, communities must adopt proper definitions associated with floodplain management requirements. The definitions needed to guide the designer in understanding floodplain management requirements are also found in Part 44 of the Code of Federal Regulations (CFR), Section 59.1. For a complete list of floodplain management terms used in this manual, refer to *Appendix B: Glossary of Terms*. Definitions of key floodplain management terms used in this manual are provided below:

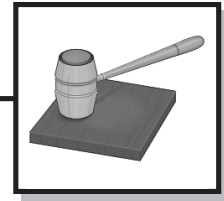
**Base Flood Elevation (BFE):** The elevation of the flood having a one-percent chance of being equaled or exceeded in any given year. The BFE is determined by statistical analysis for each local area, and designated on the FIRM. The BFE is also known as the 100-year flood elevation.

**Basement:** Any area of the structure having its floor subgrade (below ground level) on all sides.

**Design Flood Elevation (DFE):** The regulatory flood elevation adopted by a community that is the BFE, at a minimum, and may include freeboard, as adopted by the community.

**Enclosed Area Below the FPE:** An unfinished flood-resistant enclosure, usable solely for parking, building access, or storage in an area other than a basement that is below the lowest floor.

**Flood Protection Elevation (FPE):** The elevation to which flood protection measures are designed. It is normally the sum of the expected flood



elevation (the BFE at a minimum) plus freeboard (also referred to as Design Flood Elevation or Flood Protection Level).

**Freeboard:** A factor of safety usually expressed in feet above a flood level for purposes of floodplain management. Freeboard tends to compensate for the many unknown factors that could contribute to flood heights greater than the height calculated for a selected size flood and floodway conditions, such as wave action, blocked bridge or culvert openings, and the hydrological effect of urbanization of the watershed.

**Lowest Floor:** The lowest floor of the lowest enclosed area (including basement). An unfinished or flood-resistant enclosure usable solely for parking, building access, or storage in an area other than a basement is not considered a building's lowest floor, provided that such enclosure is not built so as to render the structure in violation of the applicable non-elevation design requirement of 44 CFR, section 60.3.

**New Construction:** For the purposes of determining insurance rates, structures for which the "start of construction" commenced on or after the effective date of an initial FIRM or after December 31, 1974, whichever is later, and includes any subsequent improvements to such structures. For floodplain management purposes, "new construction" means structures for which the "start of construction" commenced on or after the effective date of a floodplain management regulation adopted by a community and includes any subsequent improvements to such structures.

**Special Flood Hazard Area (SFHA):** Portion of the floodplain subject to inundation by the base flood, designated Zone A, AE, A1 - A30, AH, AO, AR, V, VE, V1 - V30, or VO, on a FIRM.

**Structure:** For floodplain management purposes, a walled and roofed building, including a gas or liquid storage tank, that is principally above ground, as well as a manufactured home.

**Substantial Damage:** Damage of any origin sustained by a structure whereby the cost of restoring the structure to its before-damaged condition would equal or exceed 50 percent of the value of the structure before the damage occurred.



**Substantial Improvement:** Any repair, rehabilitation, addition, or other improvement of a structure, the cost of which equals or exceeds 50 percent of the value of the structure before the “start of construction” of the improvement. This includes structures that have incurred “substantial damage,” regardless of the actual repair work performed.

The term does not, however, include either:

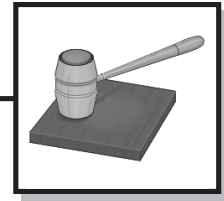
1. any project to correct existing violations of state or local health, sanitary, or safety code specifications that have been previously identified by the local code enforcement official and that are the minimum necessary to assure safe living conditions, or
2. any alteration of an “historic structure,” provided that the alteration will not preclude the structure’s continued designation as an “historic structure.”

### 2.4 NFIP Requirements for Existing Buildings

NFIP minimum floodplain management requirements generally apply to new buildings and to buildings that have been substantially improved or substantially damaged. A building is substantially improved if the cost of a repair, rehabilitation, addition or other improvement to the structure equals or exceeds 50 percent of its market value. A building is substantially damaged if the cost to repair the building to its before-damaged condition equals or exceeds 50 percent of its market value. The community permit official makes the determination of whether or not a building is substantially improved or substantially damaged and applies the provisions of the community’s floodplain management regulations and building codes to the building.

Generally, a substantially improved or substantially damaged residential building must be elevated to or above the BFE. Substantially improved or substantially damaged non-residential buildings must either be elevated or dry floodproofed (made watertight) to that elevation. Building utilities must be provided the same protection that is provided for a new building.

Some communities have adopted more restrictive requirements for substantial improvement and substantial damage. For example some communities



have a lower threshold than 50% for determining when a building is substantially improved or substantially damaged, or count all improvements and damages cumulatively over a specified time period or for the life of the building. Some states and communities require that all additions to buildings be elevated regardless of their size. Consult with your community permit official to determine if more restrictive requirements apply.

Existing buildings that are not substantially damaged or substantially improved are generally not required to meet floodplain management requirements contained in community floodplain management regulations or building codes. However, in most cases it is advisable to provide flood protection to building utility systems even if there is no requirement to do so. For further discussion, see Chapter 4, Existing Buildings.

A difficulty that communities have had in implementing substantial damage requirements after a flood has been that some building owners could not afford the cost of bringing their buildings into compliance with community floodplain management regulations. FEMA now provides assistance to these building owners through Increased Cost of Compliance (ICC) coverage contained in the Standard Flood Insurance Policy. Nearly all NFIP flood insurance policies on buildings now include ICC coverage. Exceptions are buildings located in communities enrolled in the NFIP Emergency Program, insured under Group Flood Insurance Policies or insured under a Condominium Unit Owner Policy.

Policyholders can now be reimbursed not only for the costs to repair actual physical damages from a flood, but also the additional costs, up to a maximum stated in the policy, to bring buildings into compliance with State and community floodplain management laws and ordinances. This coverage only applies to buildings suffering a flood loss that are declared substantially damaged or repetitively damaged by an authorized community official. Increased Cost of Compliance coverage would pay costs associated with bringing the structure including building utilities into compliance with applicable State and local floodplain management laws and ordinances.

Numerous FEMA publications provide information on retrofitting building support utility systems for existing buildings to bring them into compliance



with community floodplain management regulations or to provide additional flood protection in the absence of a regulatory requirement.

- FEMA FIA-TB-2 NFIP Technical Bulletin #2 *Flood-resistant Materials Requirements*
- FEMA FIA-TB-3 NFIP Technical Bulletin #3 *Non-residential Floodproofing Requirements and Certification*
- FEMA FIA-TB-4 NFIP Technical Bulletin #4 *Elevator Installation*
- FEMA 312 *Homeowners Guide to Retrofitting: Six Ways Of Protecting Your Home From Flood Damage*
- FEMA 259 *Engineering Principles and Practices for Retrofitting Flood Prone Residential Buildings*
- FEMA 102 *Floodproofing non-Residential Structures*

### 2.5 NFIP Building Performance Requirements

The NFIP has established minimum design performance criteria that communities participating in the NFIP must adopt and enforce, at a minimum, for structures located in an SFHA. This manual provides specific techniques that comply with the minimum NFIP performance criteria as it relates to building utility systems.

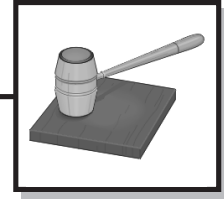
According to Part 44 of the Code of Federal Regulations, Section 60.3:

If a proposed building site is in an SFHA, the building support utility systems for all new construction and substantial improvements shall:

- i. be constructed with electrical, heating, ventilation, plumbing, and air conditioning equipment and other service facilities that are designed and/or located so as to prevent water from entering or accumulating within the components during conditions of flooding;
- ii. require within flood-prone areas new and replacement water supply systems to be designed to minimize or eliminate infiltration of flood waters into the systems;



Communities often adopt floodplain regulations that exceed the NFIP minimum requirements. More restrictive local codes and ordinances supersede the minimum requirements of the NFIP discussed in this manual. This section will examine only the minimum NFIP requirements governing construction in a Special Flood Hazard Area. Local building codes and construction criteria may vary across the country.



- iii. require within flood-prone areas new sewage systems to be designed to minimize or eliminate infiltration of flood waters into the systems and discharges from the systems into flood waters; and
- iv. onsite waste disposal systems to be located to avoid impairment to them or contamination from them during flooding.

If a proposed building site is in an SFHA, all new construction and substantial improvements shall:

- i. be designed (or modified) and adequately anchored to prevent flotation, collapse, or lateral movement of the structure resulting from hydrodynamic and hydrostatic loads, including the effects of buoyancy,
- ii. within A Zones, have the lowest floor to or above the BFE. Non-residential structures must meet the same requirements as residential structures, or be dry floodproofed so that the walls are substantially impermeable to the passage of floodwaters to or above the BFE.
- iii. Within V Zones, be elevated on pile, post, pier, or column foundations that are free of obstruction and have the lowest horizontal structural member supporting the lowest floor to or above the BFE.
- iv. be constructed with materials resistant to flood damage, and
- v. be constructed by methods and practices that minimize flood damages.

If a subdivision proposal or other proposed new development is in a flood-prone area, any such proposals shall be reviewed to assure that:

- i. all such proposals are consistent with the need to minimize flood damage within the flood-prone area;
- ii. all public utilities and facilities, such as sewer, gas, electrical, and water systems are located and constructed to minimize or eliminate flood damage; and
- iii. adequate drainage is provided to reduce exposure to flood hazards.





FEMA provides guidance on compliance with the minimum requirements of the NFIP and has technical guidance manuals and information on effective flood protection design and construction. The U.S. Army Corps of Engineers (USACE) and the Natural Resources Conservation Service (NRCS) also have developed technical guidance manuals and information for public distribution on effective flood protective design and construction techniques. In addition, some states, regional authorities, and communities have developed guidance documents intended to address flooding problems found within their specific area. These publications, many of which are listed in Appendix A, Bibliography and Sources of Information, contain guidelines for the use of certain techniques and materials for design and construction that meet or exceed NFIP performance criteria. These publications also contain information on the generally accepted practices for flood-resistant design and construction.

### 2.6 Building Codes

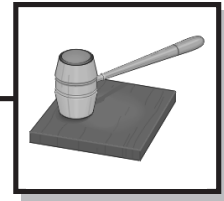


Given the variation of building codes and standards in use throughout the United States, it is very important that the reader contact the community permit office to determine what floodplain management provisions are applicable.

FEMA has also undertaken a multi-year effort to incorporate the NFIP flood-damage-resistant design standards into the nation's model building codes and standards. FEMA's goal in this effort is to ensure that model building codes are in compliance with the minimum requirements of the NFIP. In recent years, this effort has focused on the International series of codes under development by the International Code Council.

States and communities often employ a broad range of regulatory approaches to manage floodplain development and construction. These regulatory approaches include building codes, ordinances, floodplain management ordinances, and other land use regulations such as a zoning ordinance, subdivision ordinance, and a stormwater management ordinance, often are employed separately or in combination. When a combination of regulatory approaches is utilized, there can be contradictory floodplain management requirements. Normally, when this occurs, the more restrictive provisions apply. But, in all cases, local regulatory officials shall determine what requirements apply.





### 2.6.1 Model Building Codes

When they decide to adopt building codes, most states and communities adopt all or portions of model building codes and standards. Model building codes have been developed over a period of years under the auspices of various nonprofit organizations. The most widely accepted model codes in the United States are shown below (refer to *Table 2.6.1* for more detailed data about the building codes):

**National Code Series:** developed by the Building Officials and Code Administrators International (BOCA), generally adopted by eastern and mid-western states;

**Standard Code Series:** developed by the Southern Building Code Congress International (SBCCI), generally adopted by southern states;

**Uniform Code Series:** developed by the International Council of Building Officials (ICBO), generally adopted by western states;

**International Code Series:** Under development by BOCA, ICBO and SBCCI; generally will be adopted nationally in lieu of existing model building codes.

**One- and Two-Family Dwelling Code:** developed by the Council of American Building Officials (CABO), used for residential structures in various parts of the country; and

**NFPA Life Safety Code:** developed by the National Fire Protection Association (NFPA), used as a standard for fire protection in various parts of the country. This code is referenced in several other code series.

**Manufactured Housing Regulations and Accompanying Standards:** developed by the Department of Housing and Urban Development (HUD) and other related organizations.

Documents for each of the above code series follow standardized formats for content and references. Most model code groups also maintain product material evaluation reports, which contain specific testing information on a variety of building products.

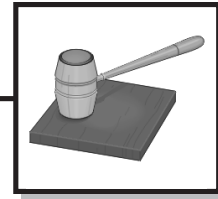
#### **NOTE:**

In addition to the provisions in the codes, some professional organizations have published guidelines intended for use when designing buildings in floodplains. For example, the Structural Engineering Institute (SEI) of the American Society of Civil Engineers (ASCE) recently published a standard 24-98 titled *Flood Resistant Design and Construction*.



National Codes (BOCA):	<ul style="list-style-type: none"> <li>• BOCA National Building Code</li> <li>• BOCA National Fire Prevention Code</li> <li>• BOCA National Mechanical Code</li> <li>• BOCA National Plumbing Code</li> <li>• BOCA Property Maintenance Code</li> </ul>
Standard Codes (SBCCI):	<ul style="list-style-type: none"> <li>• Standard Building Code</li> <li>• Standard for Floodplain Management</li> <li>• Standard Plumbing Code</li> <li>• Standard Existing Building Code</li> <li>• Standard Housing Code</li> <li>• Standard Fire Prevention Code</li> </ul>
Uniform Codes (ICBO):	<ul style="list-style-type: none"> <li>• Uniform Building Code</li> <li>• Uniform Mechanical Code</li> <li>• International Plumbing Code</li> <li>• Uniform Fire Code</li> <li>• Uniform Housing Code</li> </ul>
NFPA Standards:	<ul style="list-style-type: none"> <li>• NFPA 101—Life Safety Code</li> <li>• NFPA 70—National Electrical Code</li> <li>• NFPA 54 National Fuel Gas Code</li> <li>• NFPA 58 Standard for the Storage and Handling of Liquefied Petroleum Gases</li> </ul>
CABO One- and Two- Family Dwelling Code:	<ul style="list-style-type: none"> <li>• CABO One- and Two- Family Dwelling Code</li> </ul>
Manufactured Housing Regulations and Standards:	<ul style="list-style-type: none"> <li>• ANSI A225.1-87, Manufactured Home Installations</li> <li>• HUD Manufactured Home Construction and Safety Standards, Part 3280 with interpretative bulletins</li> <li>• Permanent Foundations Guide for Manufactured Housing, 4930.3</li> <li>• Model Manufactured Home Installation Manual</li> <li>• NFPA 501A—987 Standard for Fire safety Criteria for Manufactured Home Installations, Sites, and Communities</li> <li>• ANSI A40, Safety Requirements for Plumbing - 93 Addition</li> </ul>
International Code Council:	<ul style="list-style-type: none"> <li>• International Building Code*</li> <li>• International Residential Code*</li> <li>• International Fire Code</li> <li>• International Fuel Gas Code</li> <li>• International Plumbing Code</li> <li>• International Private Sewage Disposal Code</li> <li>• International Mechanical Code</li> </ul> <p style="text-align: right; margin-top: 10px;">*under development at the time this manual went to print</p>

**Table 2.6.1: Model code groups and associated model codes**



The following is a discussion of the general contents of the International Code Series. These discussions include reference to the appropriate chapters and sections.

### **INTERNATIONAL RESIDENTIAL CODE (2000)**

The International Residential Code (IRC) is tailored by the community when it is adopted to incorporate data related to various hazards, including snow load, wind, seismic, cold weather, and flooding. The community inserts in the table the date of entry into the NFIP and the date of the effective Flood Insurance Rate Map (FIRM) or other more restrictive regulatory flood hazard map the local jurisdiction has adopted.

General flood resistant construction provisions are in Section 327, including establishment of the design flood elevation (DFE). Protection of mechanical and electrical systems is covered in Section 327.1.5, where elevation above the design flood elevation is specified. Electrical components are required to be elevated unless they conform to the requirements for wet locations. Ducts and duct installation are not allowed below the DFE.

Section 327.1.6 includes requirements for the protection of water supply and sanitary sewage systems. Both types are to be designed to minimize infiltration into the systems, and sewage systems must be designed to minimize discharges into floodwater. The plumbing provisions of the IRC are referenced along with Chapter 3 of the International Private Sewage Disposal Code.

The International Fuel Gas Code is cited in Chapter 24, requiring gas appliances to be elevated or protected to prevent flood water from entering or accumulating within them.

### **INTERNATIONAL BUILDING CODE (2000)**

In Chapter 27, the IBC refers to the NFPA 70 for electrical components, equipment and systems. Both the International Mechanical Code and the International Fuel Gas Code are referenced as governing heating, air conditioning, refrigeration, mechanical installations, and for ventilation, and chimneys, fireplaces and barbecues. Chapter 29 covers plumbing systems and equipment, which are governed by the International Plumbing Code. Private sewage disposal is required to conform to the International Private Sewage Disposal Code.

#### **ICC Mission**

On December 9, 1994, the International Code Council (ICC) was established as a nonprofit organization dedicated to developing a single set of comprehensive and coordinated national codes.

The ICC founders-BOCA, ICBO, and SBCCI - created the ICC in response to technical disparities among the three sets of model codes now in use in the U.S.



When elevators and conveyor systems are included in the design of buildings in special flood hazard areas, the Chapter 30 of the IBC references ASCE 24 for specifications for installation in a Special Flood Hazard Area (SFHA) other flood hazard area as designated by a local jurisdiction.

### **INTERNATIONAL PLUMBING CODE (1997)**

Section 309 specifically addresses systems and equipment in structures in flood hazard and high-hazard zones, requiring them to be capable of resisting hydrostatic and hydrodynamic loads and stresses, including the effects of buoyancy. Certain system elements specifically are required to be sealed or elevated, including water supply pumps, potable water well seals, and manhole covers.

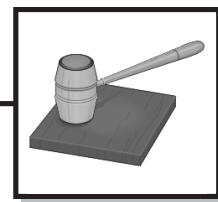
### **INTERNATIONAL PRIVATE SEWAGE DISPOSAL CODE (1997)**

Certain types of private sewage disposal systems involve placement of fill dirt. Chapter 3 of the IPSDC is comprehensive in that prior to approval of a disposal system, the code official is required to receive written evidence that construction in and filling of floodplain areas is acceptable. The IPSDC includes a number of restrictions on placement of private sewage disposal systems in floodways. And in flood fringe areas, installations must be on land that is contiguous to land outside the floodplain. When a proposal includes placement of fill for the building and a sewage disposal system, the filled areas must be connected. Mound systems are not allowed in the floodplain.

Chapter 8 addresses placement and replacement of holding tanks and in areas with existing development, and requires that they be floodproofed, adequately anchored to counter buoyant forces, and vents and service manholes are required to be at least 2 feet above the regional (regulatory) flood elevation established by the local jurisdiction. Septic tanks in the floodway are to be floodproofed.

### **INTERNATIONAL FUEL GAS CODE (1997)**

Chapter 13 of the IFGC includes the general requirement that appliance installations are to be placed above the BFE or protected to prevent water from entering or accumulating within appliances, ducts or plenum spaces.



### **INTERNATIONAL MECHANICAL CODE (1998)**

The IMC, in Chapter 3, includes the general requirement that mechanical systems are to be placed above the BFE or protected to prevent water from entering or accumulating within appliances, ducts or plenum spaces. Plenum spaces and ducts are addressed in Chapter 6. They are required to be located above the BFE or protected to prevent water from entering. Alternatively, if located below the BFE, plenum spaces and ducts are required to be capable of resisting hydrostatic and hydrodynamic loads and stresses, including buoyancy.

### **INTERNATIONAL ELECTRICAL CODE (1999)**

Chapter 12 refers to the *International One- and Two-Family Dwelling Code* or NFPA 70, as applicable. The NFPA does not include provisions specific to floodplain areas, although a number of specifications are set forth for wet locations.

### **INTERNATIONAL FIRE CODE (Date not available)**

FEMA is working closely with the model building code groups to ensure that NFIP requirements will be accessible, credible, and easier to use and enforce by the building community. This ongoing effort is aimed at placing as many of the NFIP floodplain management requirements as possible into the model building codes. For more information on the model building codes, contact the local building and permitting officials or refer to the model code organizations.

## **2.7 National Consensus Standards**

There are a number of organizations that have been approved by the American National Standard Institute (ANSI) to produce and maintain national National Consensus Standards. FEMA has been working closely with the American Society of Civil Engineers (ASCE) to include flood-resistant design and construction provisions into two consensus standards. These ANSI-approved standards are:



*ASCE 7: Minimum Design Loads for Buildings and other Structures.* This standard includes information on how to determine flood loads and load combinations on buildings and other structures. ASCE-7 is incorporated into both the International Residential Code and the International Building Code.

*ASCE 24: Flood Resistant Design and Construction.* This standard includes information on how to design and construct buildings and others structures to be resistant to flood damage. ASCE 24 is incorporated by reference, into the International Building Code and is the basis for the flood resistant requirement contained in the International Residential Code.

### 2.8 Health and Sanitary Regulations

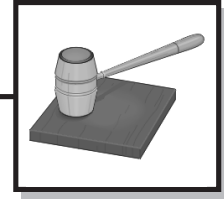
The installation of an on-site sewage disposal and water supply system often is regulated through a combination of building, land use, floodplain management, health or sanitary ordinances, laws, or regulations. These rules can be administered through a building, land use, floodplain management, health or environmental protection agency at the community, county, regional, or State level. In communities that administer building codes and floodplain management requirements, it is not unusual for health and sanitary regulations to be administered by a county, region, or State.

Many building, land use, floodplain management, or health and sanitary regulations bar or severely restrict the installation of on-site sewage disposal and water supply systems in flood-prone areas. Other building, land use, floodplain management, and health regulations provide highly detailed information on how to install on-site sewage disposal and water supply systems in flood-prone areas. For more information, contact the responsible building, land use, floodplain management, health or environmental protection agency in your community.

### 2.9 After the Flood - Guidelines for Building Officials

Several organizations have published information that can be helpful when repairing or replacing building support utility systems damaged as a result of flooding. The following provides information about particular problems that might be encountered.

Some flood damaged buildings may contain wires using fibrous insulation. If these wires are inundated by floodwaters, they must be replaced because



the fibers tend to deteriorate when exposed to water. If the insulation deteriorates, short-circuiting becomes a possibility and electrocution or fire may result. When replacing the wire, refer to the information in this chapter to assist in the selection of wire that can withstand inundation by flood. Even when water-resistant wire is used, ample time should be provided after inundation with floodwaters to allow the wires to dry fully before they are re-energized.

### 2.9.1 *Guidelines for Handling Water Damaged Electrical Equipment*®, by the National Electrical Manufacturers Association (NEMA)

#### **Guidelines for Handling Water Damaged Electrical Equipment**

##### **Use of this Publication**

This publication provides guidelines on how to handle electrical equipment that has been exposed to water through flooding, fire fighting activities, hurricanes, etc. It is designed for use by suppliers, installers, inspectors and users of electrical products.

Electrical equipment exposed to water can be extremely dangerous if reenergized without proper reconditioning or replacement. Reductions in integrity of electrical insulation due to moisture, debris lodged in the equipment components and other factors, can damage electrical equipment by affecting the ability of the equipment to perform its intended function. Damage to electrical equipment can also result from flood waters contaminated with chemicals, sewage, oil and other debris which will affect the integrity and performance of the equipment.

Distributors of electrical equipment should not use any inventory that has been subjected to water damage. Damaged inventory should not be sold to resellers that will place the equipment back into the market. This can lead to damaged equipment still being used and creating a hazard to individuals or property.

##### **To Contact the Manufacturer**

Working knowledge of electrical systems and of the equipment in question is required to evaluate damage due to contact with water. The original manufac-



© Copyright 1995 by the National Electrical Manufacturers Association.





turer of the equipment should be contacted if any questions arise or specific recommendations are needed. In many cases, replacement will be necessary.

After consultation with the manufacturer, some larger types of electrical equipment may be reconditioned by properly trained personnel. The ability to recondition the equipment may vary with the nature of the electrical function, the degree of flooding, the age of the equipment, and the length of time the equipment was exposed to water.

Attempts to recondition equipment without consulting the manufacturer can result in additional hazards due to the use of improper cleaning agents which can further damage the equipment (see National Electrical Code Section 110-11 FPN No.2) or due to improper reconditioning techniques.

NEMA member companies are committed to safety. For specific contacts within these manufacturing firms, call or write:

National Electrical Manufacturers Association  
1300 North 17th Street, Suite 1847  
Rosslyn, Virginia 22209  
Telephone: (703) 841-3268  
Fax: (703) 841-3368  
ATTN: Larry Miller  
email: lar\_miller@nema.org

### **Electrical Distribution Equipment**

Electrical distribution equipment usually involves switches and low-voltage protective components such as molded case circuit breakers and fuses, within assemblies such as enclosures, panelboards and switchboards. These assemblies can be connected to electrical distribution systems using various wiring methods.

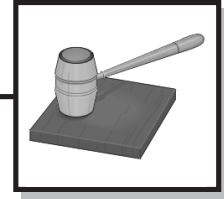
The protective components are critical to the safe operation of distribution circuits. Their ability to protect these circuits is adversely affected by exposure to water and to the minerals and particles which may be present in the water. In molded case circuit breakers and switches, such exposure can affect the overall operation of the mechanism through corrosion, through the presence of foreign particles, and through removal of lubricants. The condition of the contacts can be affected and the dielectric insulation capabilities of internal materials can be reduced. Further, some molded case circuit breakers are equipped with electronic trip units and the functioning

#### **NOTE:**

Although panel boards can sometimes be cleaned and repaired, circuit breakers must normally be replaced in residential systems.

© Copyright 1995 by the National Electrical Manufacturers Association.





of these trip units might be impaired. For fuses, the water may affect the filler material. A damaged filler material will degrade the insulation and interruption capabilities.

Distribution assemblies contain protective components together with the necessary support structures, buswork, wiring, electromechanical relays and meters. Exposure to water can cause corrosion and insulation damage to all of these areas. In the case of exposure of distribution assemblies to water, the manufacturer should be contacted before further action is taken.

***Items Which May Possibly Be Reconditioned by Trained Personnel in Consultation with Manufacturer.***

- Enclosed switches - reference NEMA Standards Publication *KS 1-1996, Enclosed and Miscellaneous Distribution Equipment Switches (600 Volts Maximum)*, para 5.1, 5.1.2
- Busway - reference NEMA Standards Publication *BU 1.1-1996, General Instructions for Handling, Installation, Operation, and Maintenance of Busway Rated 600 Volts or Less*, para 3.4.4, 9.2.4.2
- Panelboards - reference NEMA Standards Publication *PB 1.1-1991, General Instructions for Proper Installation, Operation, and Maintenance of Panelboards Rated 600 Volts or Less*, para. 8.3, 8.3.1.3, 8.3.1.4
- Switchboards - reference NEMA Standards Publication *PB 2.1-1991, General Instructions for Proper Handling, Installation, Operation and Maintenance of Deadfront Distribution Switchboards Rated 600 Volts or Less*, para. 9.3.1.3, 9.10

### **Motor Circuits**

Motor circuits include motor control devices such as motor starters and contactors, together with overcurrent protection components such as overload relays, circuit breakers, and fuses often assembled into motor control panels and motor control centers as well as individual enclosures. Motor control centers contain both control and protective components together with support structures, buswork and wiring.

The protective components are critical to the safe operation of motor circuits and their ability to protect these circuits is adversely affected by exposure to water, and to the minerals and particles which may be present in the water.

© Copyright 1995 by the National Electrical Manufacturers Association.



For molded case circuit breakers, such exposure can affect the overall operation of the mechanism through corrosion, through the presence of foreign particles, and through removal of lubricants. The condition of the contacts can be affected and the dielectric insulation capabilities of internal materials can be reduced. Further, some molded case circuit breakers are equipped with electronic trip units, and the functioning of these trip units might be impaired. For fuses, the water may affect the filler material. A damaged filler material will degrade the insulation and interruption capabilities.

Corrosion, loss of lubrication and insulation quality can also be expected in contactors and starters. However, solid-state motor controllers and those electromechanical contactors or starters with integral electronic circuitry will be more severely affected by water.

### ***Items Requiring Complete Replacement***

- Electronically controlled and solid state contactors and starters
- Components containing semiconductors and transistors
- Overload relays
- Adjustable-speed drives
- Molded case circuit breakers and molded case switches - reference NEMA Standards Publication *AB 4-1996, Molded Case Circuit Breakers and Molded Case Switches*, para 2.2
- Fuses

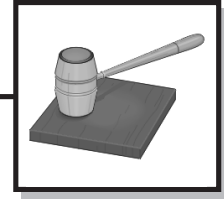
### ***Items Which May Possibly Be Reconditioned by Trained Personnel in Consultation with Manufacturer***

- Manual and magnetic motor controllers
- Motor control centers

### **Power Equipment**

Power equipment involves low voltage or medium voltage protective devices within an overall switchgear assembly. The assembly will also contain cabling, buswork with appropriate insulators, current transformers, electromechanical or solid state relays, and metering.

© Copyright 1995 by the National Electrical Manufacturers Association.



Reliable operation of the protective devices is vital to system safety; however, these devices can be adversely affected by water. In the case of low voltage and medium voltage circuit breakers and switches, the operation of the mechanism can be impaired by corrosion, by the presence of particles such as silt, and by the removal of lubricants. The dielectric properties of insulation materials and insulators will degrade and, for air circuit breakers, the condition of the contacts can be affected. Further, low voltage and medium voltage power circuit breakers usually incorporate electronic trip units; the functioning of these units will be impaired.

In the case of fuses, water may affect the filler material. A damaged filler material will degrade the insulation and interruption capabilities of fuses.

Power circuit breakers and medium voltage breakers are designed to be maintainable with the possibility, for example, of replacing contacts in air circuit breakers. It may, therefore, be possible to reuse such breakers provided the refurbishing is performed in close consultation with the manufacturer. This would include cleaning and drying techniques, lubrication advice, and thorough testing prior to the reapplication of power. However, the electronic trip units should be discarded and replaced, or at least returned to the manufacturer for inspection and possible refurbishment.

In the case of fused equipment, the fusible units should be replaced, and the remainder of the apparatus would then be refurbished in close consultation with the manufacturer.

In all cases, great attention must be paid to the thorough cleaning, drying, and testing of insulators and insulation material.

The power equipment can be expected to contain additional electronic units such as solid state relays. These units can also be vital to the correct functioning of the protective device, and great care is needed in the cleaning and testing of such units. A first recommendation is to return the devices to the manufacturer. If this is not possible, the manufacturer should be consulted, for example, on the correct selection of cleaning agents which remove impurities without damaging the conformal coating. The manufacturer must also be contacted relative to the exact testing required of sophisticated electronic equipment containing, for example, microprocessors.

© Copyright 1995 by the National Electrical Manufacturers Association.



The overall power equipment assembly (switchgear) could be reconditioned provided careful steps were taken in the cleaning, drying and testing of the equipment prior to applying power. This would require input and advice from the manufacturer. An area of particular concern is the maintenance of the dielectric properties of insulators. In the field application of medium voltage equipment, for example, stand-off insulators are subjected to a wide variety of high voltage surges. Such insulators might need replacement.

### ***Items Requiring Complete Replacement***

- Fuses
- Electronic trip units of low and medium voltage power breakers

### ***Items Which May Possibly Be Reconditioned by Trained Personnel in Consultation with Manufacturer***

- Alternating current high-voltage circuit breakers - reference NEMA Standards Publication *SG 4-1990, Alternating-Current High Voltage Circuit Breaker*, para 6.12
- Low voltage power circuit breakers
- Protective relays and current transformers
- Low voltage switchgear
- Medium voltage switchgear

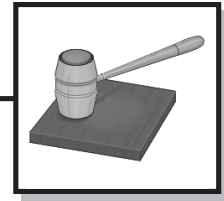
### **Transformers**

Exposure of transformers to water can cause corrosion and insulation damage to the transformer core and winding. The ability of the transformer to perform its intended function in a safe manner can also be impaired by debris and chemicals which may be deposited inside the transformer during a flood. Water and contaminants also can damage transformer fluids.

### ***Items Requiring Complete Replacement***

- All dry-type transformers regardless of kVA ratings
- All dry type control circuit transformers

© Copyright 1995 by the National Electrical Manufacturers Association.



### ***Items Which May Possibly Be Reconditioned by Trained Personnel in Consultation with Manufacturer***

- Liquid-filled transformers (analysis of the insulating medium is required for evaluation of this equipment)
- Cast-resin transformers

### **Wire, Cable and Flexible Cords**

When any wire or cable product is submerged in water, any metallic component (such as the conductor, metallic shield, or armor) is subject to corrosion that can damage the component itself and/or cause termination failures. If water remains in medium voltage cable, it could accelerate insulation deterioration, causing premature failure. Wire and cable that is listed for only dry locations may become a shock hazard, when energized, after being submerged in water.

The following recommended actions are based upon the concept that the water contains no unusually high concentrations of chemicals, oils, etc. If it is suspected that the water has unusual contaminants, such as may be found in some flood water, the manufacturer should be consulted before any decision is made to continue using any wire or cable products.

### ***Items Requiring Complete Replacement***

Any wire or cable that is listed for dry locations only, such as type NM-B cable, should be replaced if it has been submerged in water.

Any cable that contains fillers, such as polypropylene, paper, etc., should be replaced if the ends of the product have been submerged in water.

### ***Items Which May Possibly Be Reconditioned by Trained Personnel in Consultation with Manufacturer***

- Any wire or cable product that is suitable for wet locations and whose ends have not been submerged should be suitable for use or continued use. A qualified person, such as an electrical contractor or others familiar with wire and cable terminology, should make the determination of the product's suitability for wet locations.

Any wire or cable product, not containing fillers, that is suitable for wet locations and whose ends have been submerged in water, may be con-

### **NOTE:**

A Megger test can sometimes be used to determine whether or not wiring can be used after inundation by floodwaters.

© Copyright 1995 by the National Electrical Manufacturers Association.



sidered a candidate for "purging" (using an inert gas under pressure to remove water contained in the product) under engineering supervision. If this procedure is employed, the wire or cable should be tested prior to energization. As a minimum, an insulation resistance test with a megohmmeter should be conducted.

### **Wiring Devices, Ground Fault Circuit Interrupters (GFCI) and Surge Protectors**

Sediments and contaminants contained in water may find their way into the internal components of installed electrical products and may remain there even after the products have been dried or washed by the user. These may adversely affect the performance of those products without being readily apparent to the user community. Also, electrical products, such as GFCIs and surge protective devices, contain electronic circuitry and other components which can be adversely affected by water resulting in the device becoming non-functional or a hazard to the user.

As a result, such products subjected to or believed to be subjected to water damage are not suitable for continued use and must be replaced with new undamaged products. Air drying and washing of water damaged products of this type should not be attempted.

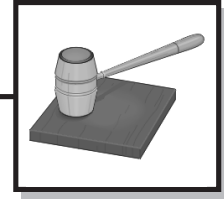
### **Lighting Fixtures and Ballasts**

Fluorescent, high-intensity discharge and incandescent lights are not intended for submersion in water except for those that are listed as submersible lighting fixtures. Flooded lighting fixtures and associated equipment may be damaged by corrosive materials, sediment, or other debris in the water. Corrosion of metallic parts and contamination of internal circuitry may prevent the equipment from operating properly. Lighting fixtures and associated equipment known to have been submerged should be replaced.

### **Motors**

Motors which have been flooded by water may be subjected to damage by debris or pollutants. This may result in damage to insulation, switches, contacts of switches, capacitors and overload protectors, corrosion of metallic parts, and contamination of the lubricating means and should be evaluated by qualified personnel.

© Copyright 1995 by the National Electrical Manufacturers Association.



The manufacturer should be contacted for specific instructions on possible disassembly, cleaning and drying of the motor housing and internal components by trained personnel. Also, a method for drying is described in ANSI/IEEE 43-1974(R1992), para A2.1 B A2.1.2.

### **Electronic Products, Including Signaling, Protection, Communication Systems and Industrial Controls**

Equipment used in signaling, protection and communication systems generally contain electronic components, and the exposure of such equipment to flooding by water can adversely affect the reliability of those systems. Contamination by pollutants or debris in flood waters may cause corrosion of components of the system, shorting of printed circuits, or alteration of circuit characteristics. Since some of these types of installations are classified as life safety systems, it is important that the reliability of those systems be maintained.

Where such systems are damaged by water, it is recommended that components of these systems be replaced or returned to the manufacturer for appropriate cleaning, recalibration, and testing. Manufacturers of these systems should be contacted for information on specific equipment.

### **Cable Tray**

Carefully inspect the cable tray system to determine if its mechanical and/or electrical integrity has been breached. (WARNING-Do not use cable tray as a walkway.) Repair or replace any damaged portions per original installation requirements. Remove all debris from the cable tray. If any labels warning against the use of the cable tray as a walkway have been obliterated, obtain new labels from the manufacturer and apply as required.

### **National Electrical Manufacturers Association**

1300 North 17th Street, Suite 1847  
Rosslyn, Virginia 22209  
Telephone: (703) 841-3268  
Fax: (703) 841-3368  
ATTN: Larry Miller  
email: lar\_miller@nema.org

© Copyright 1995 by the National Electrical Manufacturers Association.



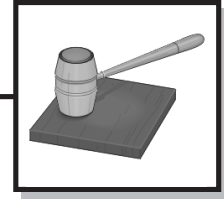


### 2.9.2 Case Study: Sonoma County, California, Flood 1997 - Electrical Requirements

Following a major flood in 1997, Sonoma County, California, issued the following guidance on how to inspect and repair electrical systems to restore them in conformance with applicable building, floodplain management, and electrical code requirements.

#### FLOOD 1997 - ELECTRICAL REQUIREMENTS

- Repair and replacement for flood damaged electrical wiring and equipment.
  - 1) These requirements apply to any electrical equipment or wiring which was submerged in flood water for any length of time, and/or sustained any other water/storm damage. An electrical permit is required for all repairs/replacements of electrical wiring/equipment. Standard electrical fees will be charged.
- Before an electrical service panel may be re-energized, it must be cleaned and dried throughout, and all circuit breakers and/or other damaged components replaced: The busbars must show no evidence of corrosion/oxidation. Its connected load must be in an electrically safe condition.
- Here's a list of electrical wiring and equipment which must be replaced without exception:
  - 1) Electronically controlled and solid-state contactors and starters.
  - 2) Components containing semi-conductors and transistors.
  - 3) Overload relays.
  - 4) Adjustable-speed drives.
  - 5) Molded case circuit breakers, switches, and receptacle outlet devices.
  - 6) Fuses.
  - 7) Any cable or wire which has been submerged at either end and thus allowing water to enter its body. *The wire/cable would not need to be replaced if PRMD were presented with a report showing the results*



*of a high voltage test (such as a “megger test”) of the wiring indicating the insulation has not failed. This test must be performed by a licensed electrician.*

- Manual and magnetic motor controlled centers may possibly be reconditioned by trained personnel.

### FLOOD 97 - ELECTRICAL CHECKLIST

This form must be completed before re-energizing service panel/finalization of building permit.

#### MANDATORY ITEMS REQUIRING REPLACEMENT

##### I Service panels and panelboards (subpanels):

- 1) Molded case circuit breakers replaced:  
yes no If ‘no’, why? \_\_\_\_\_
- 2) Fuses replaced:  
yes no If ‘no’, why? \_\_\_\_\_
- 3) Busbars clean and dry and shown no evidence of oxidation/corrosion?  
yes no If ‘no’, why? \_\_\_\_\_
- 4) Grounding Electrode system in place including water and gas bonds.  
yes no If ‘no’, why? \_\_\_\_\_

##### II House wiring system

- 5) Conductors of house wiring system tested (megometer)?  
yes no If ‘no’, why? \_\_\_\_\_
- 6) High voltage test results submitted on conductors if they’re not being replaced (use attached PRMED form or facsimile)  
yes no If ‘no’, why? \_\_\_\_\_
- 7) Appliances replaced including electric water heaters?  
yes no If ‘no’, why? \_\_\_\_\_
- 8) Electronically controlled and solid-state contactors and starters replaced?  
yes no If ‘no’, why? \_\_\_\_\_



- 9) Components containing semi-conductors  
yes no If 'no', why? \_\_\_\_\_
- 10) Overload relays and Adjustable-speed drives replaced?  
yes no If 'no', why? \_\_\_\_\_

**TEST RESULTS**

Circuit #	Type of Circuit	Test Reading	Date of Test

<b>CONTENTS</b>	<b>Page</b>
<b>3.0 Introduction</b>	<b>3.0-2</b>
<b>Sections</b>	
<b>3.1 HVAC Systems</b>	<b>3.1-1</b>
<b>3.2 Fuel Systems</b>	<b>3.2-1</b>
<b>3.3 Electrical Systems</b>	<b>3.3-1</b>
<b>3.4 Sewage Management Systems</b>	<b>3.4-1</b>
<b>3.5 Potable Water Systems</b>	<b>3.5-1</b>
<b>TABLE</b>	
<b>Table 3.0: Checklist for building support utility systems in new construction</b>	<b>3.0-4</b>



#### NOTE:

This manual does **not** discuss any dry flood-proofing design techniques for non-residential buildings. Please refer to FEMA Publication 259 - *Engineering Principles and Practices for Retrofitting Flood-prone Residential Buildings*, or FEMA Publication 102 - *Floodproofing non-Residential Structures*.

## 3.0 Introduction

Chapter 3 provides guidance for incorporating flood damage resistant techniques in the design and construction of building utilities. This guidance is applicable for both new construction and substantially improved buildings. The material is covered in terms of performance characteristics rather than specific construction techniques or approaches. In many cases, a specific design technique can be implemented in a variety of ways, as long as the minimum performance requirements of the National Flood Insurance Program (NFIP) and State, and community laws and ordinances, are met.

The NFIP requirements for building utilities are detailed in Section 44 of the Code of Federal Regulations (CFR) Chapter 1, Section 60.3(a). The NFIP requires that all new and substantially improved structures located in flood-prone areas be designed and constructed by methods and practices that minimize or eliminate flood damage to electrical, heating, ventilation, air conditioning, plumbing, and other building utility systems. A detailed discussion of the NFIP requirements can be found in Section 2.5.

#### NOTE:

The Design Flood Elevation (DFE) is a regulatory flood elevation adopted by a community that is the BFE, at a minimum, and may include freeboard, as adopted by the community.

The primary protection methods that apply to residential and non-residential building utilities and meet the minimum requirements of the NFIP include:

- the elevation of equipment and system components above the Design Flood Elevation (DFE) on pedestals, platforms, or fill, suspending them from structural elements, or moving them to upper floors or attics; and
- the protection of system components that exist below the DFE by utilizing water tight enclosures, protective utility shafts, and anchoring systems.

In the subsequent sections of this chapter we will examine these techniques for the following building utilities:

- Heating, Ventilating, and Air Conditioning (HVAC) Systems
- Fuel Systems

## New and Substantially Improved Buildings

### Introduction



- Electrical Systems
- Sewage Management Systems
- Potable Water Systems

Each building utility section will provide an introduction and summary of NFIP requirements, discuss principles and practices for the protection of major and minor system components, and conclude with a flowchart and design checklist for floodproofing the utility system. In addition, *Table 3.0* is a checklist that can be used to quickly review a new building's NFIP compliance.



**FLOOD RESISTANT NEW CONSTRUCTION CHECKLIST**

Property ID:
Property Name:
Property Address:
Reviewed By / Date:
<input type="checkbox"/> Met with the building official, floodplain manager, and other relevant community officials <input type="checkbox"/> Identified the Base Flood Elevation (BFE), First Floor Elevation (FFE), and Design Flood Elevation (DFE) <input type="checkbox"/> Building utilities must be protected from flood damage up to the DFE: _____ <input type="checkbox"/> Elevated all controls, equipment, piping wiring, ducts, etc. above the DFE
<ul style="list-style-type: none"> <li>• Heating Ventilating and Air Conditioning (HVAC):           <ul style="list-style-type: none"> <li><input type="checkbox"/> All components are elevated above the DFE</li> <li><input type="checkbox"/> Protected controls from flood inundation</li> <li><input type="checkbox"/> Protected exterior units from floodwater inundation, scour, and impact</li> <li><input type="checkbox"/> Protected exterior piping and wall penetrations below the DFE from impact and water infiltration</li> <li><input type="checkbox"/> Protected boilers from water infiltration and impact damage</li> </ul> </li> <li>• Fuel Systems:           <ul style="list-style-type: none"> <li><input type="checkbox"/> All components are elevated above the DFE</li> <li><input type="checkbox"/> Protected exterior piping and wall penetrations below the DFE from impact and water infiltration</li> <li><input type="checkbox"/> Protected fuel tank from impact, buoyancy, and scour</li> </ul> </li> <li>• Electrical:           <ul style="list-style-type: none"> <li><input type="checkbox"/> All components are elevated above the DFE</li> <li><input type="checkbox"/> Protected transformers, switch panels, service connections and meters from water infiltration</li> <li><input type="checkbox"/> Protected wiring, outlets and switches from water infiltration and damage</li> <li><input type="checkbox"/> Protected wall penetrations below the DFE from water infiltration.</li> </ul> </li> <li>• Plumbing:           <ul style="list-style-type: none"> <li><input type="checkbox"/> All components are elevated above the DFE</li> <li><input type="checkbox"/> Protected plumbing components below the DFE from impact and scour</li> <li><input type="checkbox"/> Protected sewer tank and distribution system from impact, buoyancy, and scour</li> <li><input type="checkbox"/> Protected wall penetrations below the DFE from water infiltration</li> <li><input type="checkbox"/> Protected water taps and drains below the DFE from infiltration and impact damage</li> <li><input type="checkbox"/> Protected water heaters from water infiltration and impact damage</li> </ul> </li> </ul>

**Table 3.0: Checklist for building support utility systems in new construction**



## **CONTENTS**

	<b>Page</b>
<b>3.1 Heating, Ventilating, and Air Conditioning (HVAC) Systems</b>	<b>3.1-2</b>
<b>3.1.1 Introduction</b>	<b>3.1-2</b>
<b>3.1.2 NFIP Requirements</b>	<b>3.1-2</b>
<b>3.1.3 Compressors, Heat Pumps, and Other Outdoor Equipment</b>	<b>3.1-4</b>
<b>3.1.4 Furnaces, Boilers, Water Heaters, and Other Indoor Equipment</b>	<b>3.1-8</b>
<b>3.1.5 Supporting Distribution Systems</b>	<b>3.1-13</b>
<b>3.1.6 Conclusion</b>	<b>3.1-14</b>

## **FIGURES**

<b>Figure 3.1.1: Main components of a typical HVAC system in a house in a flood-prone area</b>	<b>3.1-3</b>
<b>Figure 3.1.3A: Electric heat pumps dislodged by velocity flow during Hurricane Fran in Topsail Beach, North Carolina, in November 1996</b>	<b>3.1-5</b>
<b>Figure 3.1.3B: A cantilevered compressor platform beside a house in a velocity flow area</b>	<b>3.1-6</b>
<b>Figure 3.1.3C: Use of flood shields to enclose an outdoor compressor unit</b>	<b>3.1-7</b>
<b>Figure 3.1.4A: Elevation of HVAC components below a floor, but above the DFE</b>	<b>3.1-9</b>
<b>Figure 3.1.4B: Elevated furnace with cooling coil, electronic air cleaner, and automatic humidifier located in the attic</b>	<b>3.1-10</b>
<b>Figure 3.1.4C: Elevation of mechanical equipment on a platform in an area used only for storage, building access, or parking</b>	<b>3.1-11</b>
<b>Figure 3.1.4D: Watertight enclosure of mechanical equipment in an area used only for building access, parking, or storage</b>	<b>3.1-12</b>
<b>Figure 3.1.6: Steps involved in the design of a flood resistant HVAC system</b>	<b>3.1-15</b>

## **TABLES**

<b>Table 3.1.1: HVAC system components</b>	<b>3.1-2</b>
<b>Table 3.1.2: Summary of NFIP Regulations</b>	<b>3.1-4</b>
<b>Table 3.1.6: Checklist to aid in the review of proposed designs for compliance with Federal, State, and local regulations</b>	<b>3.1-16</b>



## 3.1 Heating, Ventilating, and Air Conditioning (HVAC) Systems

### 3.1.1 Introduction

**NOTE:**

This chapter applies to new and substantially improved structures that must be built in compliance with the minimum requirements of the NFIP. Many of the structures that were built prior to the adoption of floodplain management regulations by communities have building utilities systems that are not resistant to flood damages. For additional information on how to protect building utility systems in these structures, see Chapter 4 on Existing Buildings.

In order to live and/or work in a fully enclosed structure, people must be provided comfortable living conditions. To achieve these conditions, the air within closed structures often is heated in the winter and cooled in the summer, and is continuously refreshed and circulated to maintain an adequate level of comfort. HVAC systems serve this function.

In general, HVAC system components can be divided into **Main Equipment** and the **Supporting Distribution System**. Some components of these systems are located indoors, while others are located outdoors. *Table 3.1.1* presents portions of the typical HVAC system and their typical locations. *Figure 3.1.1* shows a typical HVAC system installation in a flood-prone area.

	MAIN EQUIPMENT	SUPPORTING DISTRIBUTION SYSTEM
<b>OUTDOOR</b>	Compressor/Condenser/Heat pump/Evaporative cooler units	Gas/Oil storage tanks Gas/Oil fuel supply lines Electrical supply lines
<b>INDOOR</b>	Furnace with evaporator coil/ Air handler Boiler	Duct work (room air ducts—supply and return) Refrigerant lines Combustion air intake line Hydronic piping Pump Terminal units (radiators)

**Table 3.1.1: HVAC system components**

In general, the figures in this chapter attempt to illustrate some general practices that meet the requirements of the National Flood Insurance Program (NFIP). Local codes permit many variations that also meet NFIP regulations. Please refer to your local code officials for specific practices that may meet both NFIP regulations and local code.

### 3.1.2 NFIP Requirements

The NFIP requires that the HVAC system in a new or substantially improved structure located in a Special Flood Hazard Area (SFHA) be de-

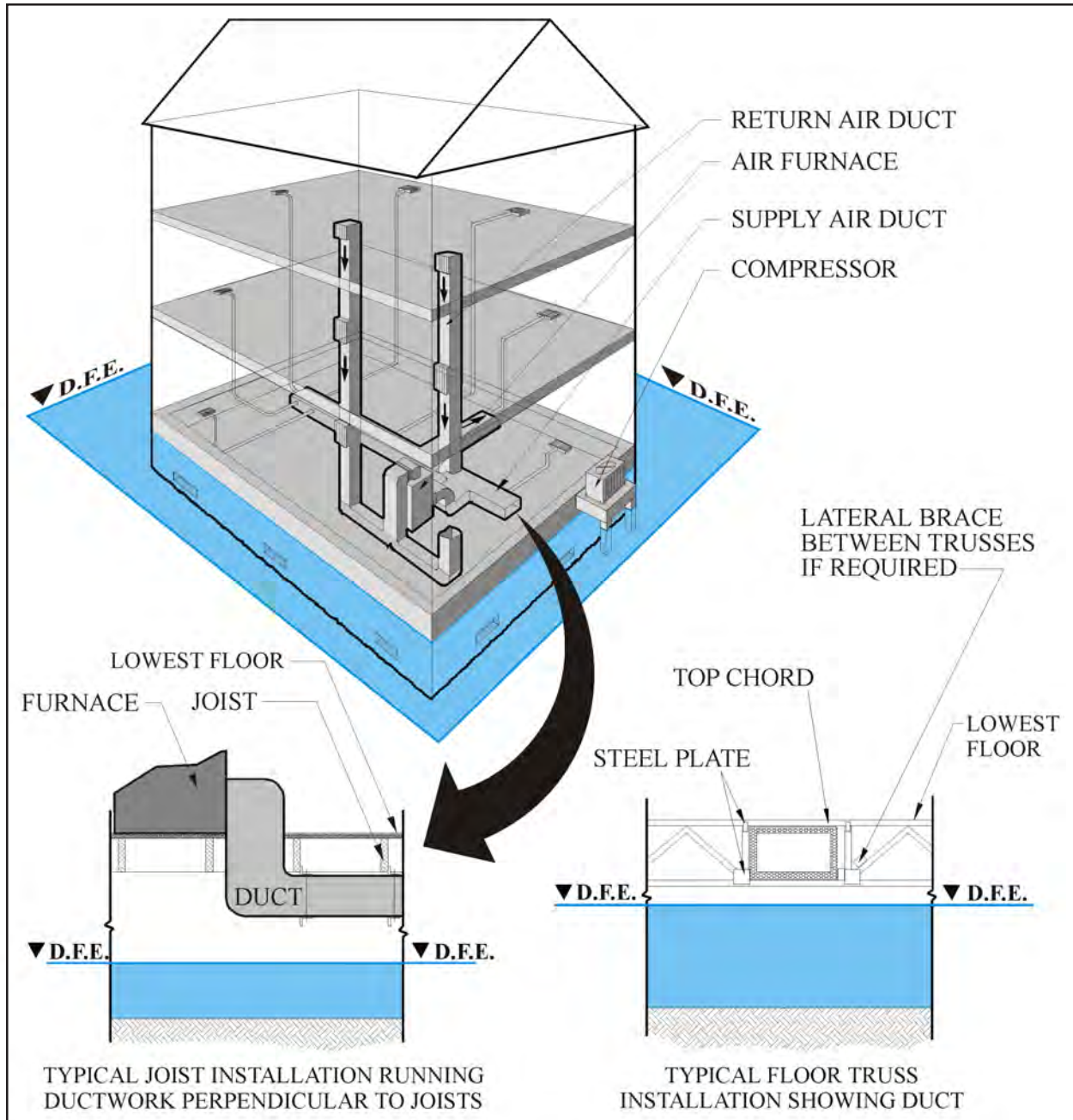


Figure 3.1.1: Main components of a typical HVAC system in a house in a flood-prone area



## New and Substantially Improved Buildings HVAC Systems

signed so that floodwaters cannot infiltrate or accumulate within any component of the system. *Table 3.1.2* summarizes NFIP compliant methods.

Methods of Mitigation	A Zones	V Zones
1. Elevation	Highly Recommended	Minimum Requirement
2. Component Protection	Minimum Requirement	Not Allowed*

**Table 3.1.2: Summary of NFIP regulations**

\*Allowed only for those items required to descend below the DFE for service connections.

### NOTE:

The Design Flood Elevation (DFE) is a regulatory flood elevation adopted by a community that is the BFE, at a minimum, and may include freeboard, as adopted by the community.

1. **Elevation** refers to the location of a component above the Design Flood Elevation (DFE).
2. **Component Protection** refers to the implementation of design techniques that protect a component or group of components located below the DFE from flood damage by preventing floodwater from entering or accumulating within the system components.

### 3.1.3 Compressors, Heat Pumps, and Other Outdoor Equipment

With most outdoor HVAC equipment, the main issues presented by floodwaters are inundation, velocity flow, and debris impact. The control and power circuits and mechanical parts in HVAC equipment, even when they are designed for outdoor installation, are not designed to withstand inundation by floodwater. They are also not designed to withstand the dynamic forces of high velocity flow and debris impact. During inundation, the electric and electronic control and power units would likely short-circuit, and the mechanical equipment would fail to operate and may be torn away. Most of the metal components would eventually corrode and deteriorate, especially in areas inundated by floodwaters containing salt. High velocity flow in either riverine or coastal areas can dislodge equipment from their stands and separate connecting pipes, hoses, and power lines. These situations occurred in Topsail Beach, North Carolina during coastal flooding caused by Hurricane Fran in November of 1996. *Figure 3.1.3A* shows electric heat pumps that were dislodged due to the forces of velocity flow.



Always refer to local building codes, floodplain management regulations and other applicable requirements before installing HVAC equipment. Many states and communities have adopted more restrictive requirements than the NFIP minimums discussed in this manual.



**Figure 3.1.3A:** Electric heat pumps dislodged from their stands by velocity flow during Hurricane Fran in Topsail Beach, North Carolina, in November 1996

### Elevation

The most effective flood-resistant design for outdoor HVAC equipment is to strap or bolt the equipment onto a platform above the DFE. Some basic guidelines when elevating HVAC equipment are:

- The strapping or bolting mechanism must be designed to withstand wind, earthquake, and other required forces as specified in the local building codes and ordinances.
- In coastal areas, the platform can often be cantilevered out from the structure at an elevation above the DFE.
- If this is not possible, then the platform can often be supported on piles, posts, or columns that are embedded into the soil below the expected depth of erosion, scour, and frost.



Some codes specify access for maintenance and safety precautions for all building utility systems, particularly in non-residential applications.





## New and Substantially Improved Buildings HVAC Systems

### NOTE:

In a large residential or non-residential building it is common to locate the HVAC compressor on the roof of the building. The rooftop location for these units protects them from flood damage.

- If necessary, cross-bracing of piles and posts, together with concrete footings, should be used to increase the resistance of the platform to wind, velocity flow, and seismic forces (cross-bracing should only be installed parallel to the direction of flow to permit free passage of debris and floodwaters).
- In addition, the platform should be located on the landward side (in coastal areas) or the downstream side (in riverine areas) of the structure to protect against velocity flows and debris impact.

Figure 3.1.3B shows a typical cantilevered HVAC platform application.

The elevation of outdoor HVAC equipment on platforms is suitable for small residential and non-residential buildings.

No matter what structure the units are located on, HVAC units should be equipped with vibration dampening devices and the structures upon which

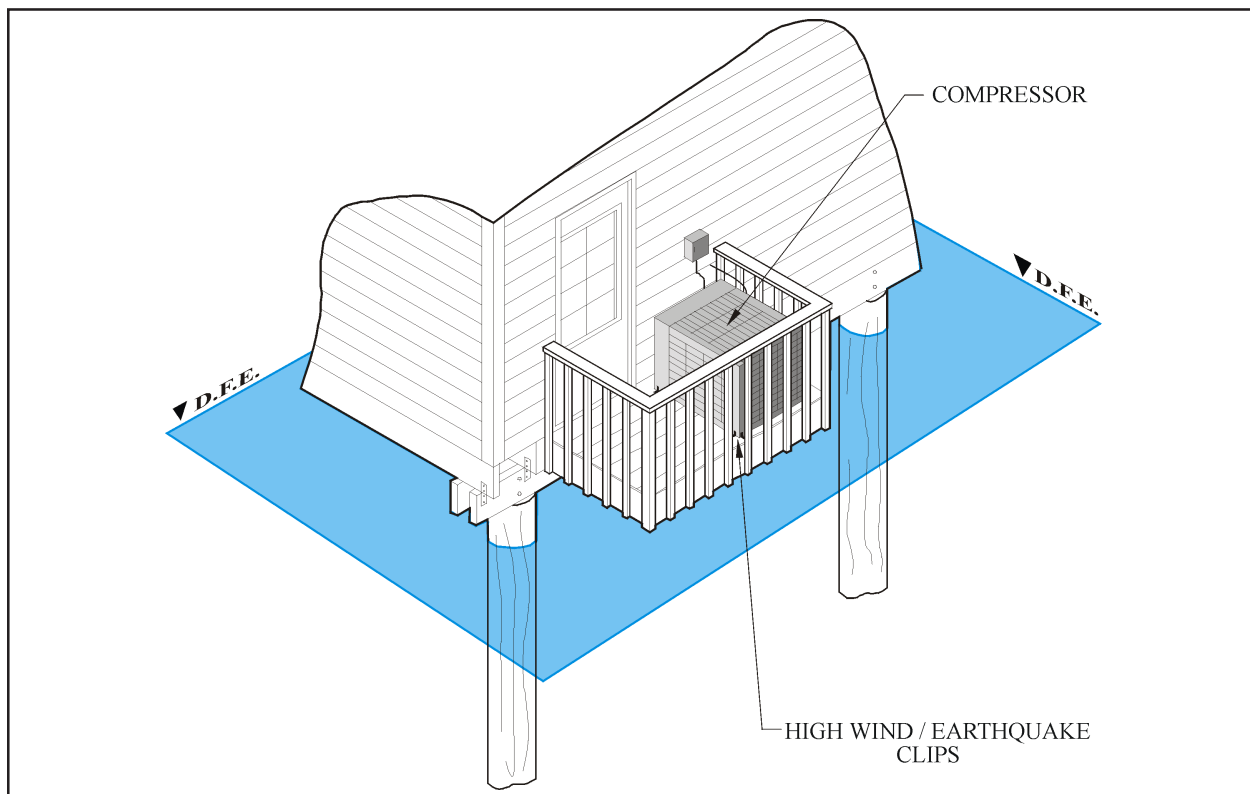


Figure 3.1.3B: A cantilevered compressor platform beside a house in a velocity flow area



they rest should be properly designed to withstand vibrations for extended periods of time. In addition, the units should be anchored in place so that the equipment is not permitted to move as a result of the vibrations.

Air conditioning systems are equipped with condensate drain pans. These pans must be located to allow free draining above the DFE. If the drainpipe extends below the DFE, the system could back up and the drain could become a conduit for the introduction of floodwaters into the system. This would damage the unit, and could flood the area where the unit is housed.

### Component Protection

Where outdoor HVAC main equipment located in an A Zone cannot be elevated above the DFE, it can still be protected from inundation by enclosing the unit within watertight walls. The top of the walls of the enclosure must be at or above the DFE, and there must be access for servicing. *Figure 3.1.3C* illustrates a typical concrete and steel flood shield arrangement. Enclosures can also be constructed of steel.

#### NOTE:

Component protection is only permitted in A zones.

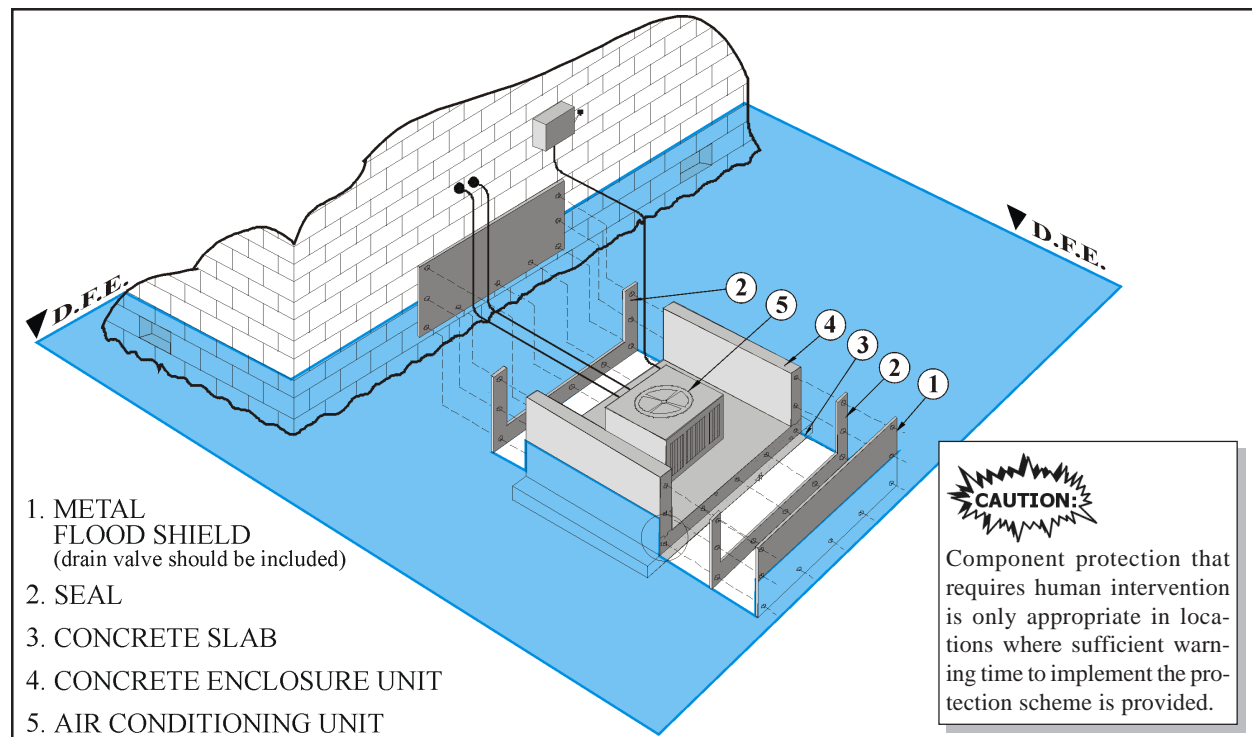


Figure 3.1.3C: Use of flood shields to enclose an outdoor compressor unit at grade





Component protection that requires human intervention is only appropriate in locations where sufficient warning time is provided to implement the flood protection scheme.

If a watertight enclosure without a roof cover is used, allowances must be made for drainage of the structure to prevent rainwater from damaging the equipment located inside the enclosure. A typical enclosure might include a check valve that will permit water leaving the enclosure, but will prevent it from entering the enclosure.

Note that component protection using watertight walls is generally used when construction of pedestals is not feasible. For flood protection of HVAC system equipment in most new and substantially improved buildings, construction of pedestals provides a simpler and more cost-effective solution than watertight walls.

### 3.1.4 Furnaces, Boilers, Water Heaters, and Other Indoor Equipment

Floodwaters inundating a gas or oil furnace would extinguish the flame in the burner of the furnace and/or cause a short-circuit of the furnace's ignition control component and possible corrosion damage. In an electric furnace inundated by floodwaters, the heating element would short-circuit and require replacement.

Further, floodwaters would cause silt or mud sedimentation within the components of any inundated furnace, i.e., the air intake, combustion chamber, blower, vent pipes, air ducts and pumps. Attempts to use the furnace with these materials within the components would be hazardous as it could cause short-circuits, fires, and/or improper/incomplete combustion.



#### Elevation

1. The most effective flood protection technique is to locate the furnace or boiler on a floor that is elevated above the DFE.
2. Elevation can also be achieved by using a lateral or in-line furnace that fits into the ductwork at any location above the DFE. Such furnace units usually include a blower. For cooling, an evaporator coil can be added to the same unit. *Figure 3.1.4A* shows a typical horizontal in-line furnace configuration.

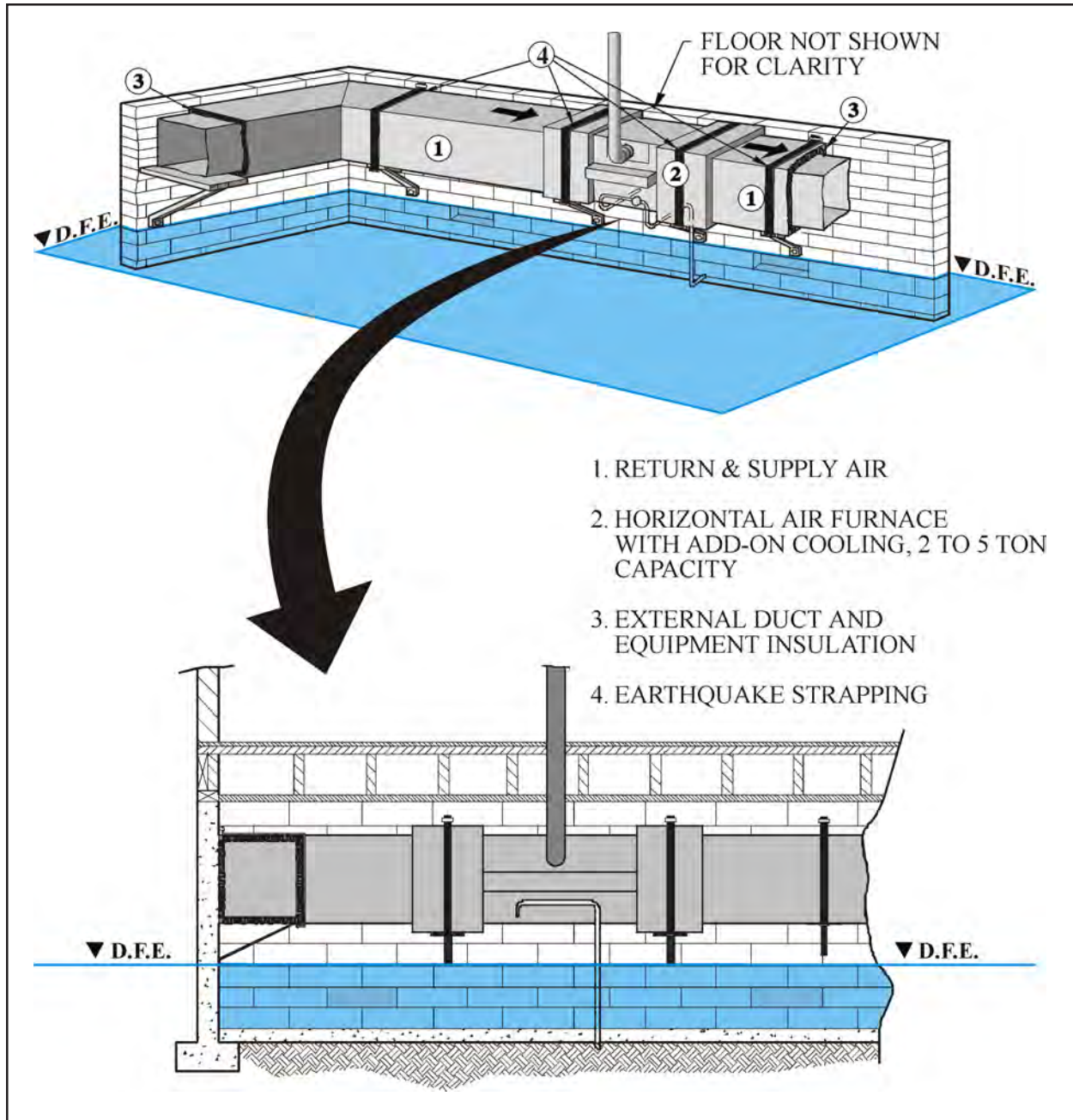
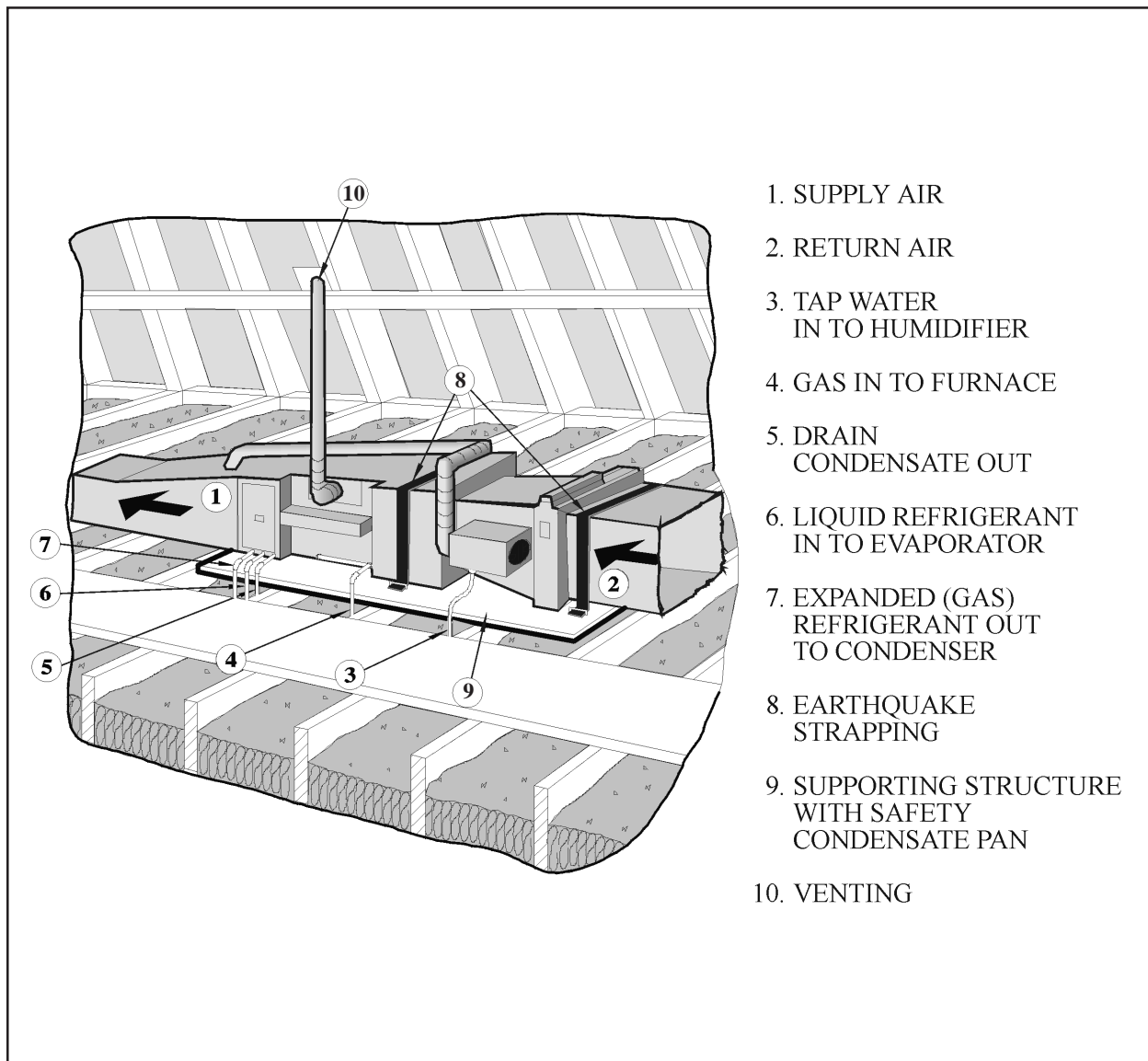


Figure 3.1.4A: Elevation of HVAC components below a floor, but above the DFE



## New and Substantially Improved Buildings HVAC Systems

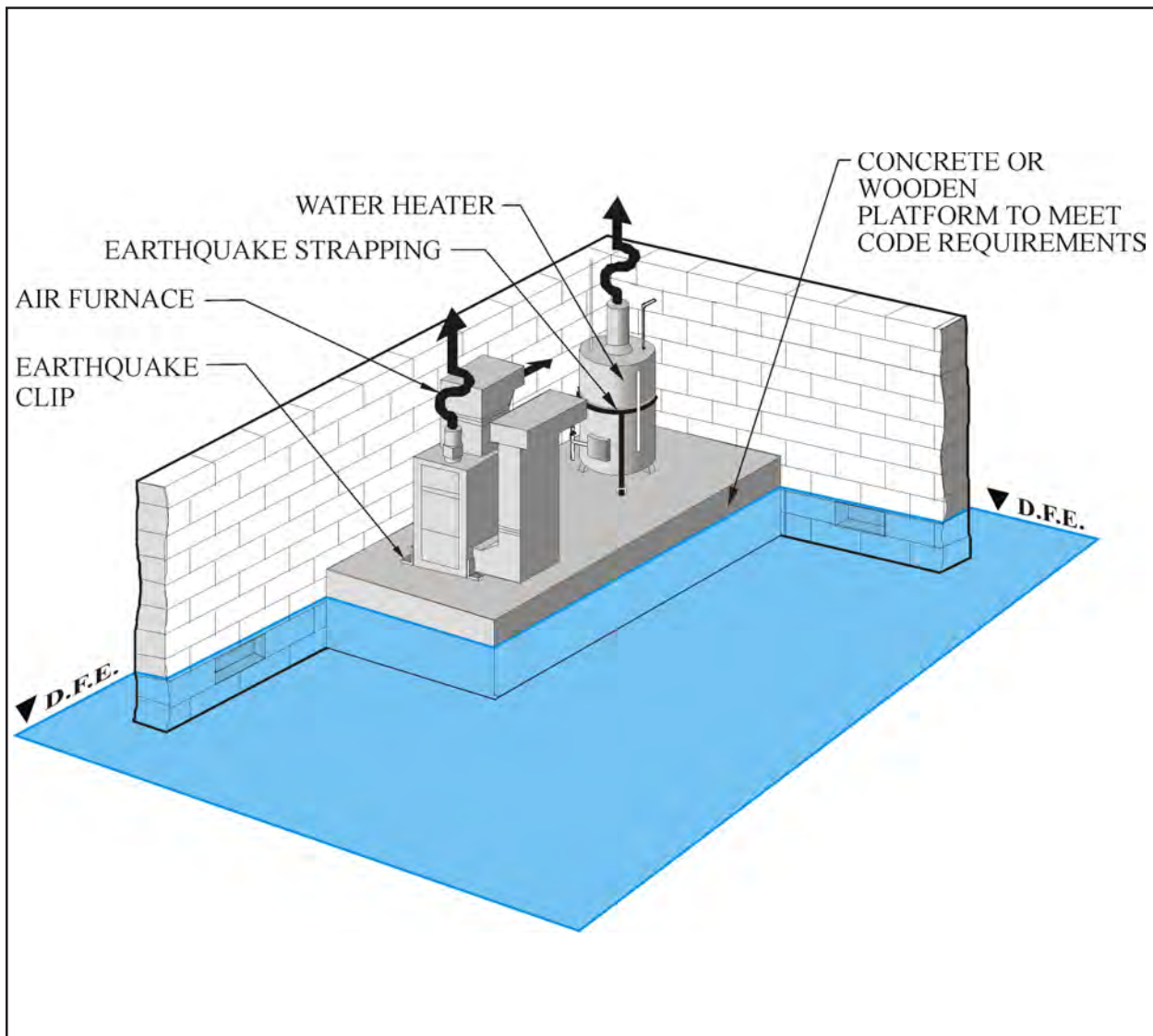
3. A furnace, boiler, or water heater can be located in the attic to protect it from floodwater inundation. *Figure 3.1.4B* shows a furnace located in an attic.



**Figure 3.1.4B:** Elevated furnace with cooling coil, electronic air cleaner, and automatic humidifier located in the attic



4. HVAC mechanical equipment can be located on a platform at or above the DFE even though the floor the platform is located on is below the DFE. The top of the platform must be above the DFE. *Figure 3.1.4C* shows pedestal- mounted mechanical equipment.



**Figure 3.1.4C:** Elevation of mechanical equipment on a platform in an area used only for storage, building access, or parking



### Component Protection

Furnaces located below the DFE in A Zones can be enclosed within watertight walls that extend above the DFE. The walls, as shown in *Figure 3.1.4D*, must be strong enough to withstand hydrostatic forces. If the flood level is low enough, a low wall or curb can be constructed without a closure panel. The closure panel should be left latched except when servicing the equipment.

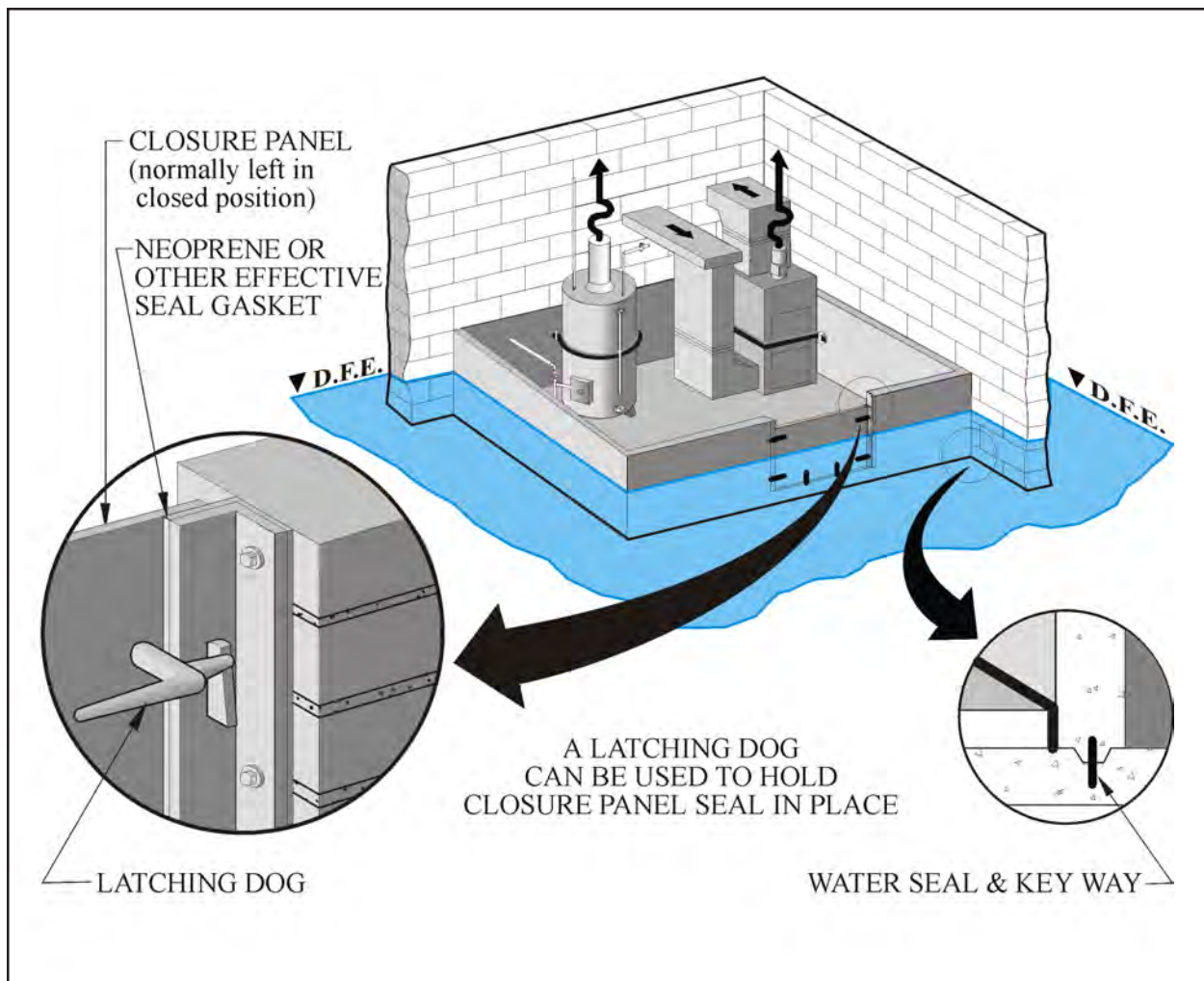


Figure 3.1.4D: Watertight enclosure of mechanical equipment in an area used only for building access, parking, or storage





Note that component protection using watertight walls is generally used when construction of platforms or pedestals is not feasible (for example, a water heater or other piece of equipment may be too tall to be elevated above the DFE and fit on a given floor). For flood protection of HVAC system equipment in new and substantially improved buildings, construction of pedestals generally provides a simpler and more cost-effective solution than watertight walls.

### 3.1.5 Supporting Distribution Systems

Supporting distribution systems include air ducts, hot water lines and electrical wiring. The hot water and electrical systems are also covered in sections 3.5 and 3.3, respectively. The NFIP requires that air ducts in HVAC systems be designed and/or located in structures in such a way that prevents water from entering or accumulating within the HVAC system components during base flooding conditions (See Section 2.5). The following problems are likely to occur when air ducts are inundated by floodwaters:

- Floodwaters may become trapped inside ductwork as flooding recedes. This often leads to the dislodging and collapse of the ductwork.
- Absorption of floodwaters by duct insulation adds more weight to the duct system than was considered in the design and installation which can result in failure of the support hardware as well as the duct itself. In addition, it is difficult and not cost effective to remove wet insulation embedded within the ducts.
- Accumulation of residue (grit, sand, mud, micro-organisms, farm chemicals, road oil, fecal material, and other contaminants) and mildew from flood waters in the duct system can cause odor and air contamination which can be a significant health hazard to the occupants of the structure.

#### Elevation

The most effective design strategy for air ducts is elevation above the DFE. This can be done by:



- Hanging the ducts from the bottom of the lowest floor or the crawl space ceiling so that the bottom of the duct is above the DFE. Refer back to Figure 3.1.1A for an example of this installation.
- Locating the ducts in the attic of the structure. This method minimizes the risk of inundation.
- Locating the ducts above a suspended ceiling.
- Locating the ducts within the habitable areas and concealing them with a bulkhead.



Locating ductwork below the DFE is not permitted unless it is designed and constructed so that floodwater will not enter or accumulate within the system components.

All controls and electrical components should be located above the DFE. These components are typically very expensive and are usually particularly susceptible to damage by floodwater inundation. Luckily, these components can usually be easily relocated above the DFE.

### Component Protection

The NFIP does not recommend locating duct work below the DFE in any new or substantially improved structure located in an SFHA. There is no known cost-effective technique for designing air ducts to keep floodwater from entering or accumulating within the system components during inundation by floodwaters.

If duct work must be installed below the DFE, it should be minimized as much as possible. The material used for the ducts must be impermeable and watertight, such as welded seamless ductwork or large diameter PVC pipe. Such material is very expensive but practical for cases where a short length of duct work descends below the DFE.

The water and fuel piping associated with HVAC systems must be properly protected from damage during flooding. PVC piping generally requires special consideration when used in flood-prone areas. This type of pipe is more susceptible to impact breakage. In addition, the nature of the material sometimes fractures or shatters when exposed to the heaving and settling that a structure experiences when withstanding floodwaters. If the lines are ruptured, it may result in contamination, leaking, or even fire. In general, copper and galvanized metal piping is better suited for use in flood-prone areas.

### 3.1.6 Conclusion

The following figure and tables have been provided which summarize the overall design approach for flood resistant HVAC systems in new and substantially improved buildings. *Figure 3.1.6* is a flow chart that outlines the basic steps involved in the design of a flood resistant HVAC system. *Table 3.1.6* is a checklist to aid in the review of proposed designs or existing systems for compliance with federal, state, and local requirements. In addition, a sketch sheet is included so that the locations or details of the system can be noted. The tables are intended to assist designers and building officials in providing the most effective level of flood protection for HVAC system components.

#### NOTE:

Component protection for duct work refers to continuous duct segments below the DFE which are watertight and terminate above the DFE. Duct segments with openings below the DFE or that terminate below the DFE are not permitted under the NFIP.

# New and Substantially Improved Buildings HVAC Systems

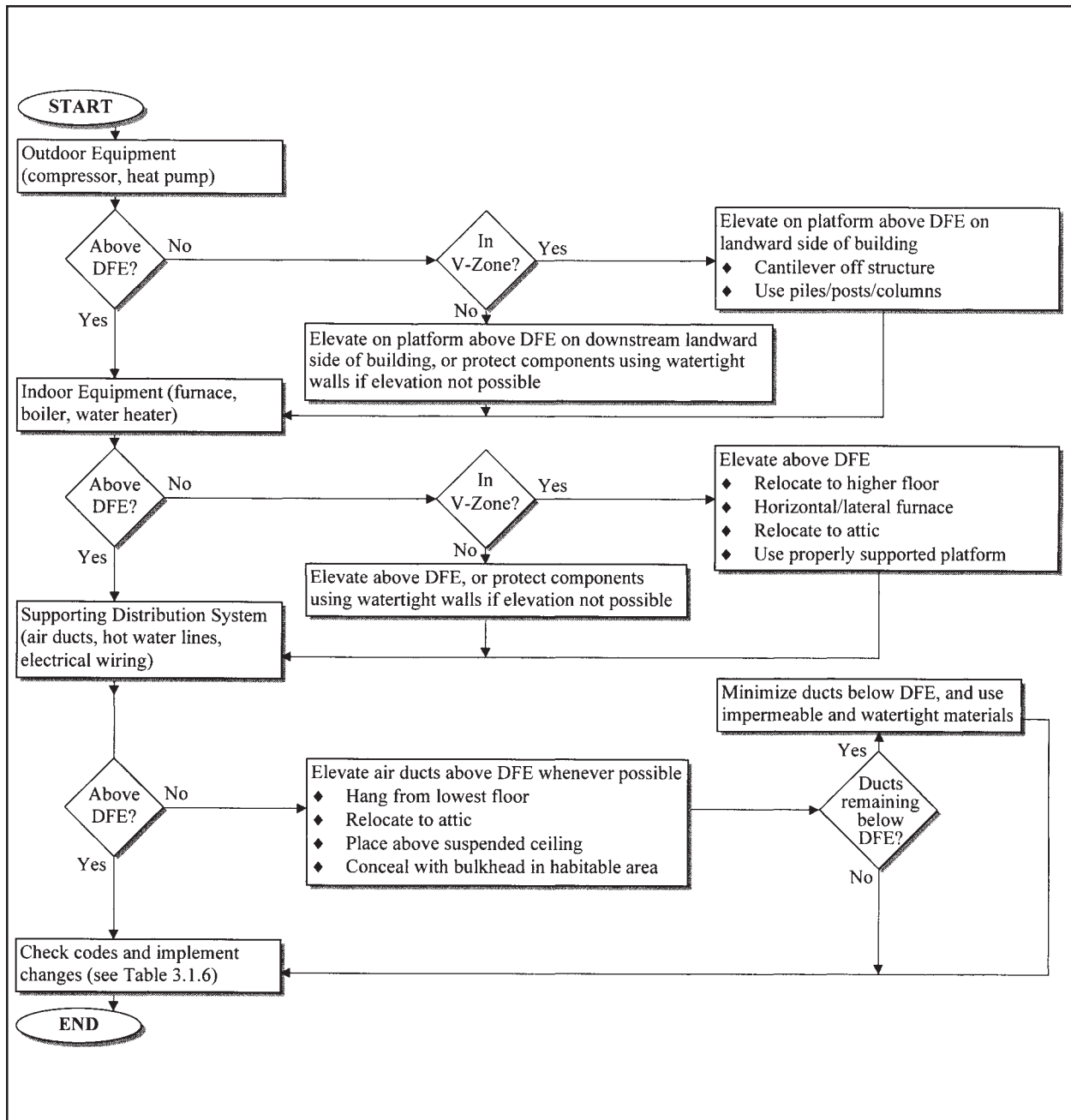


Figure 3.1.6: Steps involved in the design of a flood resistant HVAC system





## New and Substantially Improved Buildings HVAC Systems

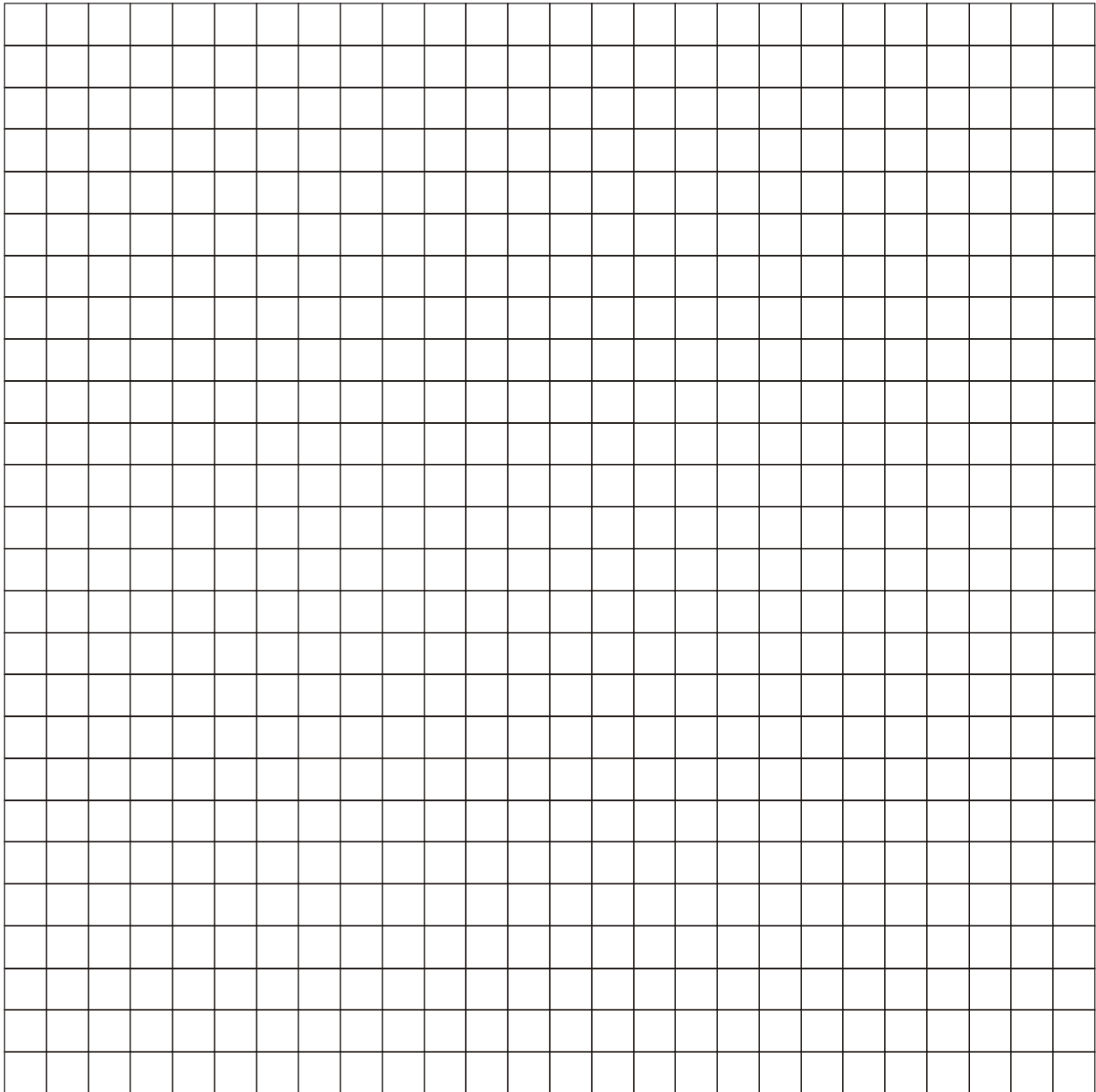
### FLOOD RESISTANT HVAC SYSTEM CHECKLIST

Property ID:		Property Contact:	
Property Name:		Interviewed:	
Property Address:		Phone:	
Surveyed By:		Date Surveyed:	
DFE:			
<ul style="list-style-type: none"> <li>• What type of heating system is used? Elevation:</li> </ul>			
<input type="checkbox"/> Natural Gas Piping type: Location of service entrance:		<input type="checkbox"/> Fuel Oil Piping Type: Tank Location:	
<input type="checkbox"/> Electric Location of electrical service entrance:		<input type="checkbox"/> Other:	
Description of Heating system:			
<ul style="list-style-type: none"> <li>• What type of A/C system is used? Elevation:</li> </ul>			
<input type="checkbox"/> Central Air Outside unit location/elevation: Inside unit location/elevation:		<input type="checkbox"/> Window units Location/elevation: Voltage:	
Description of A/C system:			
<ul style="list-style-type: none"> <li>• Does condensate drain above the DFE?</li> </ul>			
<ul style="list-style-type: none"> <li>• Are air intakes above the DFE?</li> </ul>			
Location/elevation of electronic HVAC controls:			
Is any ductwork located below the DFE? <input type="checkbox"/> Yes; elevation: <input type="checkbox"/> No			
Describe ductwork located below the DFE:			
What equipment is located beneath the DFE?			
<input type="checkbox"/> Heating Unit	<input type="checkbox"/> Outdoor Cooling Unit	<input type="checkbox"/> Indoor Cooling Unit	<input type="checkbox"/> Electronic Controls <input type="checkbox"/> Ductwork <input type="checkbox"/> Fuel Oil Tank
<input type="checkbox"/> Other:		<input type="checkbox"/> Other:	

**Table 3.1.6: Checklist to aid in the review of proposed designs for compliance with Federal, State, and local regulations**



**Sketch sheet**  
**(for details, notes, or data regarding system installations)**



<b>CONTENTS</b>	<b>Page</b>
<b>3.2 Fuel Systems</b>	<b>3.2-2</b>
<b>3.2.1 Introduction</b>	<b>3.2-2</b>
<b>3.2.2 NFIP Requirements</b>	<b>3.2-2</b>
<b>3.2.3 Fuel Storage Tanks</b>	<b>3.2-4</b>
<b>3.2.3.1 Calculation of Buoyancy Forces</b>	<b>3.2-11</b>
<b>3.2.4 Fuel Lines, Gas Meters, Control Panels</b>	<b>3.2-16</b>
<b>3.2.5 Conclusion</b>	<b>3.2-19</b>
<b>FIGURES</b>	
<b>Figure 3.2.1: An outline of a fuel system with the fuel tank elevated on a platform beside a house on a crawl space in a flood-prone area</b>	<b>3.2-3</b>
<b>Figure 3.2.3A: A fuel tank elevated above the DFE on a platform in a velocity flow area</b>	<b>3.2-5</b>
<b>Figure 3.2.3B: A fuel tank elevated on structural fill</b>	<b>3.2-6</b>
<b>Figure 3.2.3C: An underground fuel tank anchored to a concrete counterweight</b>	<b>3.2-7</b>
<b>Figure 3.2.3D: An underground fuel tank anchored onto poured-in-place concrete counterweights</b>	<b>3.2-7</b>
<b>Figure 3.2.3E: A typical tie down strap configuration of a horizontal propane tank using straps</b>	<b>3.2-9</b>
<b>Figure 3.2.3F: A typical tie down configuration of a horizontal propane tank using brackets</b>	<b>3.2-9</b>
<b>Figure 3.2.3.1A: Tank lifted by buoyancy forces</b>	<b>3.2-13</b>
<b>Figure 3.2.3.1B: Flow chart of buoyancy force calculations</b>	<b>3.2-13</b>
<b>Figure 3.2.4A: The vertical runs of fuel piping strapped against vertical non-breakaway structures</b>	<b>3.2-17</b>
<b>Figure 3.2.4B: The vertical runs of fuel piping embedded in utility shafts strapped to non-breakaway structures</b>	<b>3.2-18</b>
<b>Figure 3.2.5: Flow chart of flood resistant fuel system design</b>	<b>3.2-20</b>
<b>TABLES</b>	
<b>Table 3.2.2: Summary of NFIP regulations</b>	<b>3.2-4</b>
<b>Table 3.2.3.1A: Effective equivalent fluid weight of soil(s)</b>	<b>3.2-12</b>
<b>Table 3.2.3.1B: Soil type definitions based on USDA Unified Soil Classification</b>	<b>3.2-12</b>
<b>Table 3.2.5: Checklist for flood resistant fuel system design</b>	<b>3.2-21</b>
<b>FORMULAS</b>	
<b>Formula 3.2.3.1A: Calculation of buoyancy force exerted on a tank (tank buoyancy)</b>	<b>3.2-11</b>
<b>Formula 3.2.3.1B: Calculation of net buoyancy force</b>	<b>3.2-11</b>
<b>Formula 3.2.3.1C: Calculation of number of hold down straps</b>	<b>3.2-12</b>
<b>Formula 3.2.3.1D: Calculation of the volume of concrete necessary to resist buoyancy</b>	<b>3.2-12</b>
<b>EXAMPLE</b>	
<b>Example 3.2.3.1: Calculation of allowable load for tank straps</b>	<b>3.2-14</b>



### 3.2 Fuel Systems

#### 3.2.1 Introduction

##### NOTE:

This chapter applies to new and substantially improved structures that must be built in compliance with the minimum requirements of the NFIP. Many of the structures that were built prior to the adoption of floodplain management regulations by communities have building utility systems that are not resistant to flood damages. For additional information on how to protect building utility systems in these structures, see Chapter 4 on Existing Buildings.

The components of the fuel systems in residential and non-residential structures can be organized into two categories:

1. Fuel storage tanks
2. Fuel lines, meters, and control panels

There are four major concerns when considering the protection of fuel system components. They are:

- Buoyancy
- Impact Loads
- Scour of lines
- Movement of Connection

The tank shown in *Figure 3.2.1* is shown outside of the building. This type of installation is not the typical installation for all applications. Some tanks may be located inside a structure to provide additional protection from damage during flooding.

In general, the figures in this chapter attempt to illustrate some general practices that meet the requirements of the National Flood Insurance Program (NFIP). Local codes permit many variations that also meet NFIP regulations. Please refer to your local code officials for specific practices that may meet both NFIP regulations and local code.

#### 3.2.2 NFIP Requirements

The NFIP requires that the fuel system for a new or substantially improved structure located in a Special Flood Hazard Area (SFHA) be designed so that floodwaters cannot infiltrate or accumulate within any component of the system. See *Table 3.2.2* for a summary of compliant mitigation methods.

## New and Substantially Improved Buildings Fuel Systems

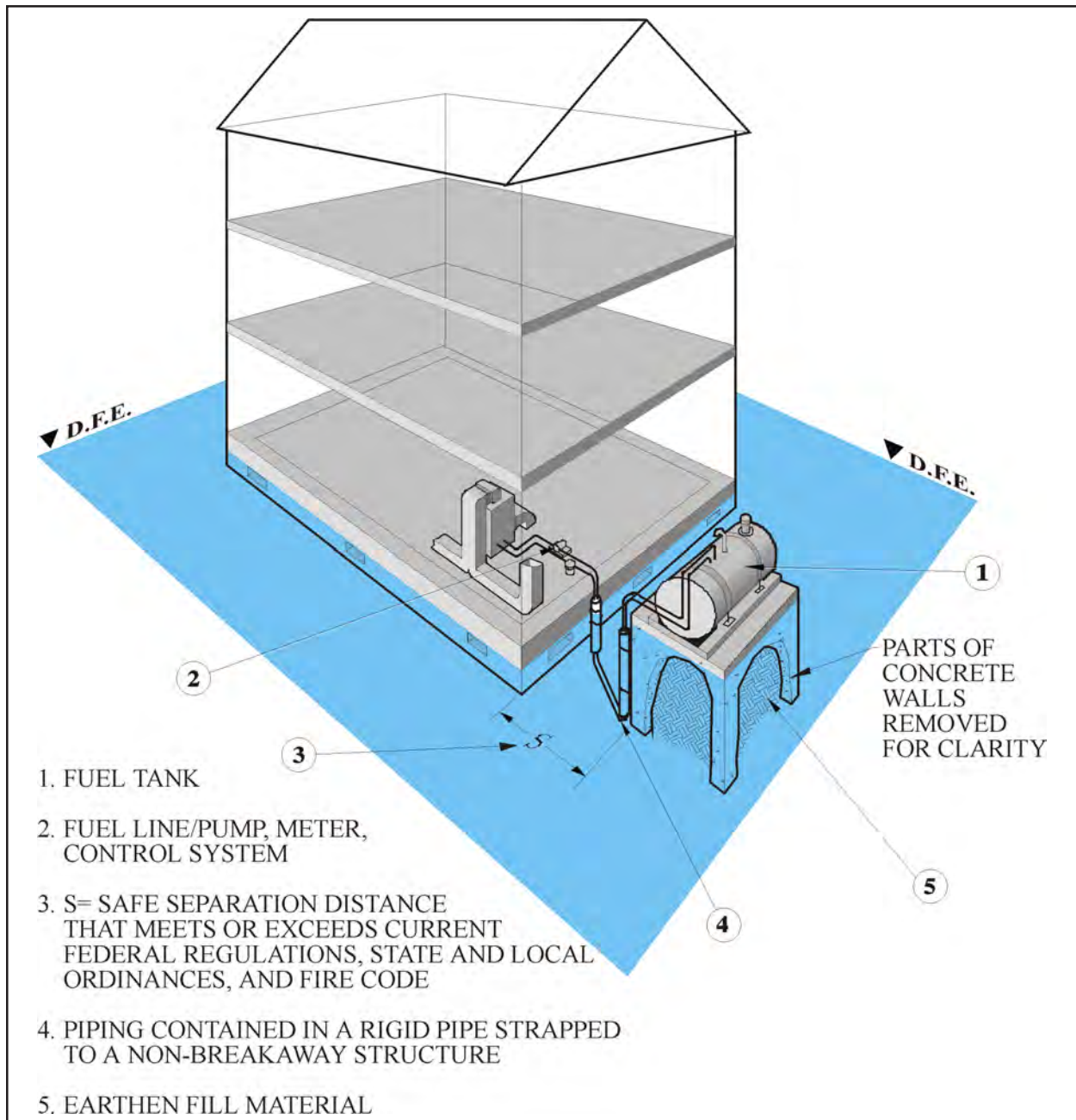


Figure 3.2.1: An outline of a fuel system with the fuel tank elevated on a platform beside a house on a crawl space in a flood-prone area



## New and Substantially Improved Buildings Fuel Systems

Methods of Mitigation	A Zones	V Zones
1. Elevation	Highly Recommended	Minimum Requirement
2. Component Protection	Minimum Requirement	Not Allowed*

**Table 3.2.2: Summary of NFIP regulations**

\*Allowed only for those items required to descend below the DFE for service connections.

### NOTE:

The Design Flood Elevation (DFE) is a regulatory flood elevation adopted by a community that is the BFE, at a minimum, and may include freeboard, as adopted by the community.

1. **Elevation** refers to the location of a component above the Design Flood Elevation (DFE).
2. **Component Protection** refers to the implementation of design techniques that protect a component or group of components located below the DFE from flood damage by preventing floodwater from entering or accumulating within the system components.

### 3.2.3 Fuel Storage Tanks

Where a structure is not connected to public gas service, the fuel for a non-electric Heating, Ventilating, and Air Conditioning (HVAC) system and other non-electric equipment is stored on-site in tanks either underground or above ground and inside or outside the building. Most modern commercial fuel tanks are of double-walled construction while most residential fuel tanks are of single-walled construction. The type of construction of the tank should be determined as some of the techniques may not apply to some types of tanks.

Both underground and above ground fuel storage tanks are vulnerable to damage by floodwaters, as illustrated by the following:

- An underground tank surrounded by floodwaters or saturated soil will be subjected to buoyancy forces that could push the tank upward. Such movement of a tank may cause a rupture and/or separation of the connecting pipes.
- Above ground tanks in V Zones and A Zones that experience velocity flow are not only subject to buoyancy forces, but they are also exposed to lateral forces caused by velocity flow, wave action, and debris impact.

### NOTE:

Refer to manufacturers' literature and professional tank installers for information regarding the proper installation of fuel storage tanks.

## New and Substantially Improved Buildings

### Fuel Systems



- An underground tank in a V Zone can be uncovered and exposed by erosion and scour, making it even more vulnerable to buoyancy forces, velocity flows, wave action, and debris impact.

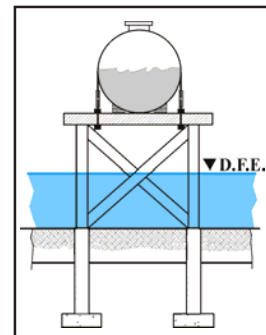
Buoyancy is described in detail later in this section. The effects of buoyancy and/or those of velocity flow can move a tank from its location, break it open, and cause fuel leakage into floodwaters. Such leakage creates the risk of fire, explosion, water supply contamination, and possible health and environmental hazards which would delay cleanup and repair work necessary to occupy the building.

### Elevation

The most effective technique for providing flood protection for a fuel storage tank is elevation of the tank on a platform above the DFE. *Figure 3.2.3A* shows a tank on an elevated platform. The depth of the footing will be dependent upon the hazards at the site. The following outlines some additional considerations when protecting fuel systems:



- The tank should be anchored to the platform with straps, which would constrain the tank in wind, earthquake, and other applicable forces.
- In coastal zones, the straps should be made of non-corrosive material to prevent rusting.
- In velocity flow areas, the platform should be supported by posts or columns that are adequately designed for all loads including flood and wind loads.
- The posts or columns should have deep concrete footings embedded below expected erosion and scour lines.
- The piles, posts, or columns should be cross-braced to withstand the forces of velocity flow, wave action, wind, and earthquakes; cross-bracing should be parallel to the direction of flow to allow for free flow of debris.
- In non-velocity flow floodplains, elevation can also be achieved by using compacted fill to raise the level of the ground above the DFE and by strapping the tank onto a concrete slab at the top of the raised ground. *Figure 3.2.3B* shows a tank located atop fill.



**Figure 3.2.3A:** A fuel tank elevated above the DFE on a platform in a velocity flow area





**CAUTION:**  
Fill is not suitable for use in areas subject to erosion and scour unless fill has been armoured.

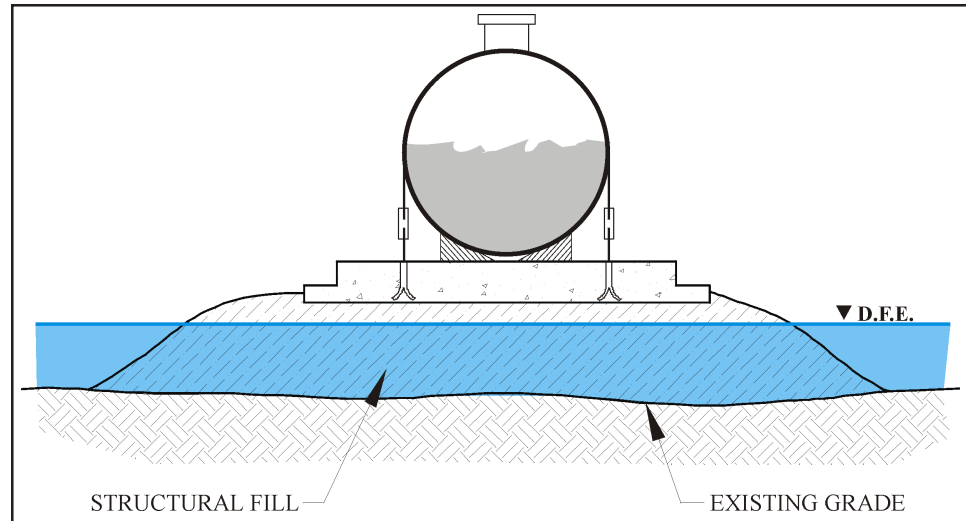


Figure 3.2.3B: A fuel tank elevated on structural fill

### Component Protection

If a fuel tank must be located below the DFE in an SFHA, it must be protected against the forces of buoyancy, velocity flow, and debris impact. This can be achieved by the following methods:

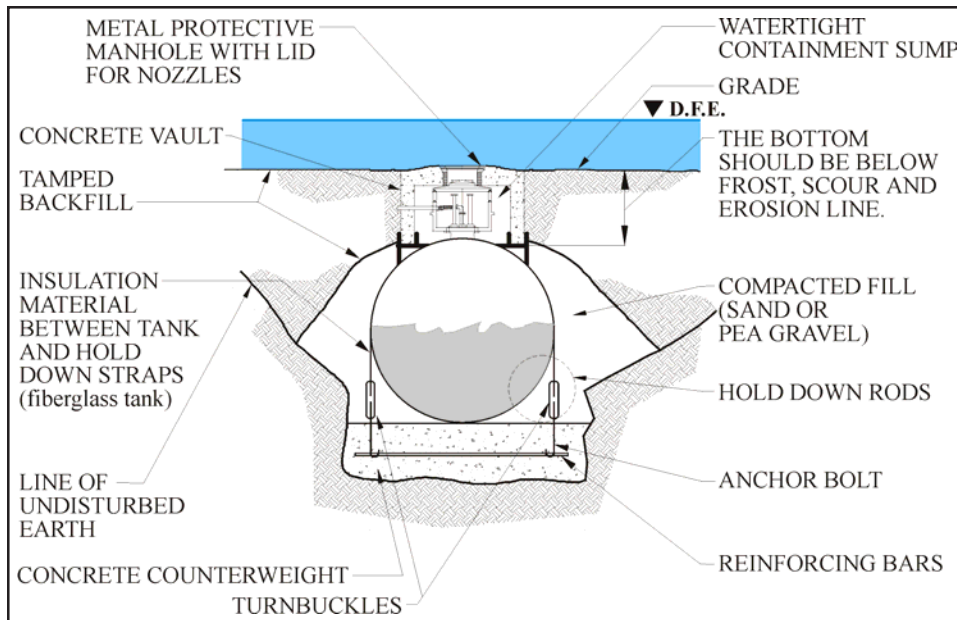
#### A. Anchoring Tanks Below Ground

1. A fuel tank located below ground in a flood-prone area can be anchored to a counterweight in order to counteract the buoyancy force that is exerted by saturated soil during a flood.

One effective method is to anchor the fuel tank to a concrete slab with (non-corrosive) hold-down straps, as shown in *Figure 3.2.3C*. The straps must also be engineered to bear the tensile stress applied by the buoyancy force. The maximum buoyancy force is equal to the weight of floodwaters which would be required to fill the tank minus the weight of the tank (see Section 3.2.3.1).

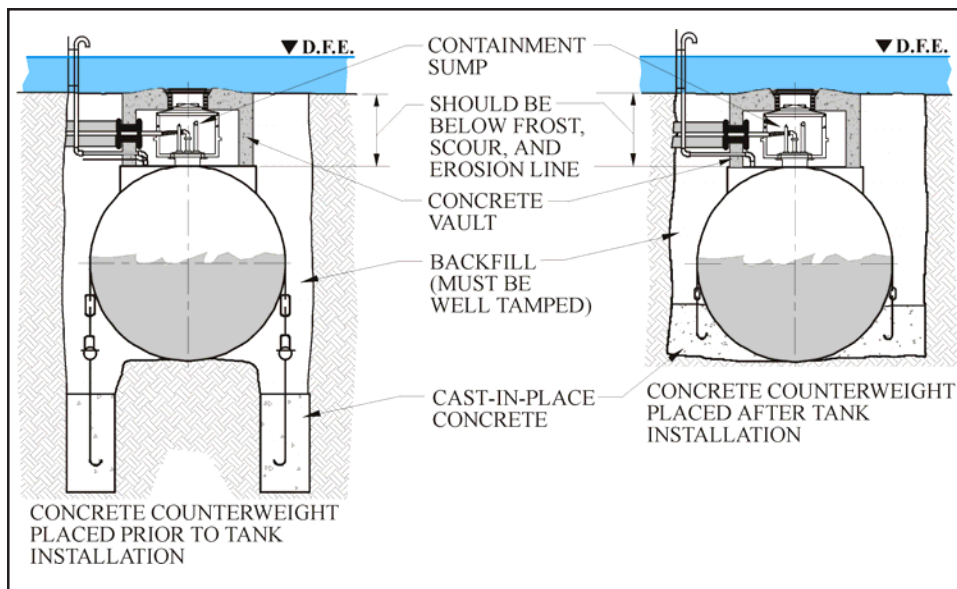
2. An alternative design technique involves strapping the tank to concrete counterweights on opposite sides of the tank, as shown in *Figure 3.2.3D*. The use of this technique is ideal for existing tanks servicing substantially improved structures. Note that the tank in this example is sitting in the concrete anchor, not on it.

# New and Substantially Improved Buildings Fuel Systems



**CAUTION:**  
Underground Storage Tank (UST) use should be minimized due to environmental concerns.

**Figure 3.2.3C: An underground fuel tank anchored to a concrete counterweight**  
Courtesy of Adamson Global Technology Corp.



**Figure 3.2.3D: An underground fuel tank anchored onto poured-in-place concrete counterweights**



### NOTE:

Soil conditions can dramatically effect buoyancy forces. Always consult with a geotechnical engineer or other knowledgeable professional that is familiar with the local soil conditions when designing anchors to counter buoyancy forces.

### NOTE:

Always refer to local code officials to determine the proper location for tanks. For example, codes typically specify that propane tanks be strapped down at least ten feet from any wall or ignition source.

3. Another technique for countering the buoyancy force is by anchoring the tank using earth augers. The holding strength of an auger is a function of its diameter and the type of soil into which the auger is embedded. The use of straps attached to augers is often well suited to an existing tank that services a substantially improved structure. In order to use this system without the risk of failure, proper soil conditions must exist. Always refer to a geotechnical engineer or other knowledgeable professional when designing auger anchors to combat buoyancy forces (see Section 3.2.3.1). Please refer to the tank manufacturers' literature to determine the proper configuration for the straps.

### B. Anchoring Tanks Above Ground

A fuel tank located above ground but below the DFE must be secured against flotation and lateral movement. This requirement applies as well to portable fuel tanks such as propane tanks.

In A Zones, that are not subject to velocity flows, the following techniques can be used:

**Mounting and strapping a tank onto a concrete slab or strapping a tank onto concrete counterweights on both sides of the tank.** The anchoring straps are typically connected to anchor bolts by turnbuckles that are installed when the concrete is poured. Please refer to the supplier's data when selecting the strap locations for anchoring tanks because a tank can rupture when buoyancy forces are too great. See *Figure 3.2.3E* for an example of a typical compliant strap configuration. In most applications, brackets, like those shown in *Figure 3.2.3F*, are designed to withstand the weight of the tank only. Buoyancy forces can exceed the weight of the tank and cause the brackets to fail. A structural engineer or manufacturer's literature should be used to verify that the bracket used to hold the tank can withstand buoyancy forces (see Section 3.2.3.1).

In coastal areas the strapping mechanism for securing a fuel tank onto a concrete slab must be made of non-corrosive material. The total weight of the counterweights or the concrete slab must be enough to counteract the buoyancy force expected to be exerted on the tank surrounded by floodwater (see Section 3.2.3.1). The sizing process for concrete counterweight is discussed in detail in Section 3.2.3.1. The counterweight can be located at or below grade.

## New and Substantially Improved Buildings Fuel Systems

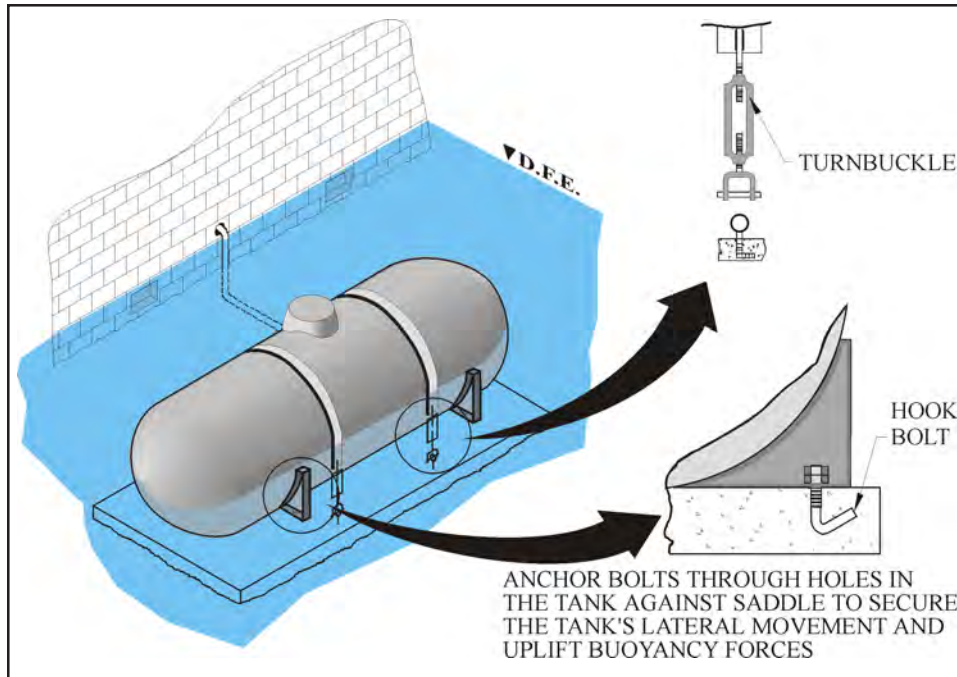


Figure 3.2.3E: A typical tie down strap configuration of a horizontal propane tank

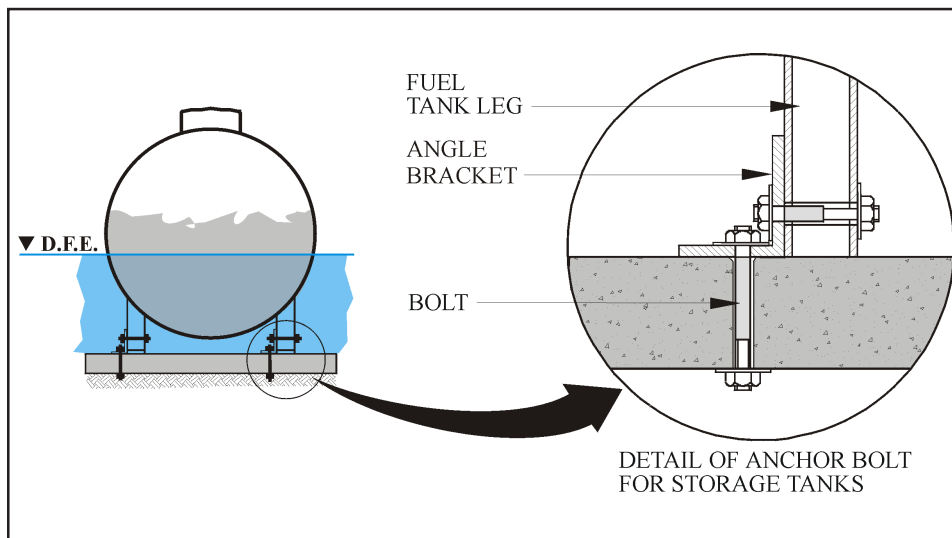


Figure 3.2.3F: A typical tie down configuration of a horizontal propane tank using brackets



## New and Substantially Improved Buildings Fuel Systems

### (NOTE:

Always consult a geotechnical engineer or other knowledgeable professional familiar with local soil conditions when selecting augers.

**Strapping a tank to earth augers.** The augers and strapping mechanism must be strong enough to withstand the buoyancy force expected during inundation and the lateral forces expected with wind and water. Earth augers are readily available from many manufacturers.

It is important to note that the performance of an auger depends upon the type of soil into which it is embedded. For example, an auger has a greater holding strength in clay soil than in sandy soil. Therefore, if the soil conditions are unknown or if the anchors selected cannot withstand anticipated loads, larger-sized or additional anchors should be used. Generally, the total holding strength of an anchoring system can be increased by increasing the number of augers, the size of the augers, or both. Earth augers and anchoring components are readily available from many manufacturers.



**CAUTION:**  
Above ground tanks under a V-zone building are obstructions and are not permitted.

Because of environmental concerns, underground storage tanks are not recommended. Elevated storage tanks are also problematic because of concerns about impact damage during flooding. Therefore, for elevated tanks, additional protection must be applied against debris impact and the forces of velocity flow. The following technique can be used to prevent damage from debris impact and the forces of velocity flow:

- Protective walls can be constructed around the tank to protect it from debris impact and the forces of velocity flow. The walls must be higher than the DFE, but they do not have to be watertight. Furthermore, there must be drainage holes at the base of the walls for rain water to drain.
- Concrete guard posts can be constructed around the tank to protect it from debris impact.

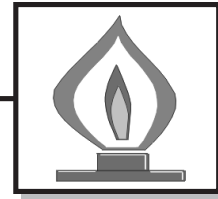
### (NOTE:

Though vault tanks are discussed in this manual, their use is typically restricted, due to construction costs, to military and larger commercial applications. However, some residential applications do exist.

### C. Vault Tanks

A vault tank is made of a primary steel tank within a secondary steel containment tank. The primary tank is coated with a layer of light-weight concrete. The typical vault is shaped like a rectangle with a sloped top to prevent accumulation of rain water. Vault tanks are available commercially for residential as well as non-residential use.

The vault is anchored to the concrete slab upon which it sits using anchoring beams welded to the bottom of the secondary/outer tank and bolted into the



concrete slab. If properly designed and constructed, the anchoring system eliminates the possibility of flotation due to buoyancy, and lateral movement due to wind and seismic activity.

For additional protection against debris impact, the vault may be surrounded by guard posts.

The fuel piping below the DFE must be strapped to the vault or contained in a protective shaft on the landward or downstream side. The vent pipe from the tank must extend above the DFE.

The vault tanks normally come with the manufacturer's calculations of the concrete volume required to counteract for buoyancy.

#### 3.2.3.1 Calculation of Buoyancy Forces

This section addresses the powerful buoyancy forces that are exerted on buried tanks. *Figure 3.2.3.1A* shows the power of buoyancy forces to lift tanks. The tank in the photo is an abandoned gas tank that came up through the asphalt and soil that had covered it. The following formulas and tables are the basic tools used when calculating buoyancy forces acting on tanks.

$$F_b = 0.134V_t\gamma FS$$

Where:	$F_b$	is the buoyancy force exerted on the tank, in pounds.
	$V_t$	is the volume of the tank in gallons.
	<b>0.134</b>	is a factor to convert gallons to cubic feet.
	$\gamma$	is the specific weight of flood water surrounding the tank (generally 62.4 lb/ft <sup>3</sup> for fresh water and 64.1 lb/ft <sup>3</sup> for salt water.)
	<b>FS</b>	is a factor of safety to be applied to the computation, typically 1.3 for tanks.

#### NOTE:

To minimize buoyancy forces, fuel tanks should be re-fueled prior to flooding.

**Formula 3.2.3.1A: Calculation of buoyancy force exerted on a tank (tank buoyancy)**

**Net Buoyancy = Tank Buoyancy ( $F_b$ ) - Tank Weight - Equivalent flood weight of soil (see Table 3.2.3.1A) acting as a counterweight(s) over Tank**

**Formula 3.2.3.1B: Calculation of net buoyancy force**





## New and Substantially Improved Buildings Fuel Systems

Soil Type*	Column A	Column B
	S, Equivalent Fluid Weight of Moist Soil (pounds per cubic foot)	Equivalent Fluid Weight of Submerged Soil and Water (pounds per cubic foot)
Clean sand and gravel: GW, GP, SW, SP	30	75
Dirty sand and gravel of restricted permeability: GM, GM-GP, SM, SM-SP	35	77
Stiff residual silts and clays, silty fine sands, clayey sands and gravels: CL, ML, CH, MH, SM, SC, GC	45	82
Very soft to soft clay, silty clay, organic silt and clay: CL, ML, OL, CH, MH, OH	100	106
Medium to stiff clay deposited in chunks and protected from infiltration: CL, CH	120	142

**Table 3.2.3.1A: Effective Equivalent Fluid Weight of Soil(s)**

Soil Type	Group Symbol	Description
Gravels	GW	Well-graded gravels and gravel mixtures
	GP	Poorly graded gravel-sand-silt mixtures
	GM	Silty gravels, gravel-sand-clay mixtures
	GC	Clayey gravels, gravel-sand-clay mixtures
Sands	SW	Well-graded sands and gravelly sands
	SP	Poorly graded sands and gravelly sands
	SM	Silty sands, poorly graded sand-silt mixtures
	SC	Clayey sands, poorly graded sand-clay mixtures
Fine grain silt and clays	ML	Inorganic silts and clayey silts
	CL	Inorganic clays of low to medium plasticity
	OL	Organic silts and organic silty clays of low plasticity
	MH	Inorganic silts, micaceous or fine sands or silts, elastic silts
	CH	Inorganic clays of high plasticity, fine clays
	OH	Organic clays of medium to high plasticity

**Table 3.2.3.1B: Soil Type Definitions Based on USDA Unified Soil Classification**

$$\text{No. of Hold Down Straps Required} = \frac{\text{Net Buoyancy}}{\text{Allowable Working Load of each strap}}$$

**Formula 3.2.3.1C: Calculation of the number of hold down straps**

$$V_c = \left[ \frac{\text{Net Buoyancy}}{\text{Density of Concrete}} \right] FS$$

**Formula 3.2.3.1D: Calculation of the volume of concrete necessary to resist buoyancy**



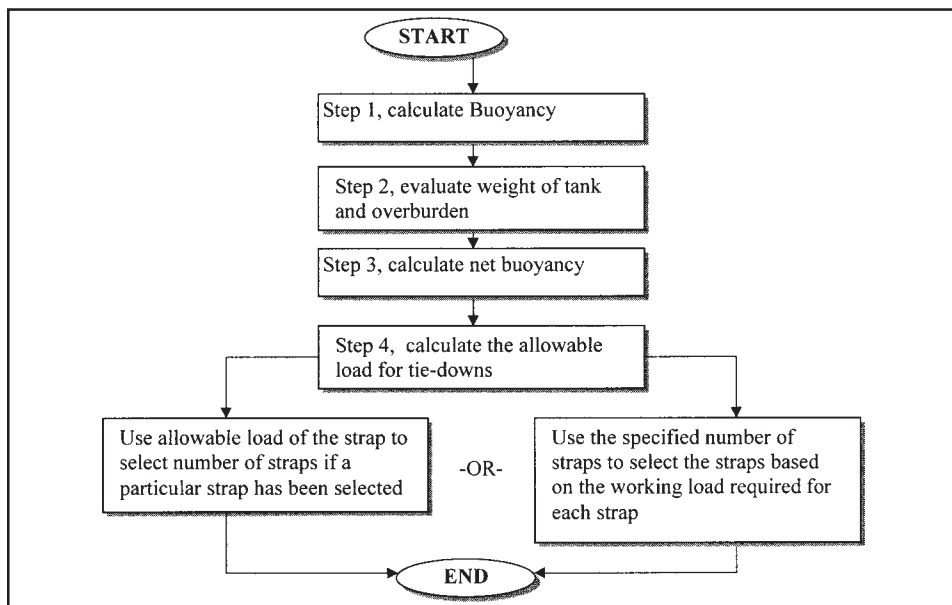
## New and Substantially Improved Buildings Fuel Systems



A buoyancy flow chart, *Figure 3.2.3.1B*, and *Example 3.2.3.1* follow *Figure 3.2.3.1A*.



**Figure 3.2.3.1A:** Tank lifted by buoyancy forces



**Figure 3.2.3.1B:** Flow chart of buoyancy force calculations



**Example 3.2.3.1: Calculation of allowable load for tank straps**

A 500-gallon fuel tank is going to be located next to a new building in a Zone AE floodplain in silty clay. The site will not be subject to velocity flow, so lateral forces and scour are not major concerns. The client is concerned about the buoyancy forces that will be acting on the tank during a flood. The tank manufacturer specified 3 locations where a strap should be installed to properly spread the load across the tank. A large concrete slab will be installed 6 feet below ground on which the tank will be fastened. The slab will be approximately 1.5 feet thick, and the top will have dimensions of 4 feet by 5.5 feet. What is the allowable load that the tie down straps will be required to withstand?

First, the dimensions of the tank must be determined. This can be obtained from the manufacturer's literature. The double-walled cylindrical tank that the client wants to use is approximately 4 feet in diameter, 5½ feet long, and weighs 650 lb.

**Step 1:** Using *Formula 3.2.3.1A*, the **Buoyancy Force ( $F_b$ )** that will be exerted on the tank, will be calculated:

$$F_b = 0.134 * 500 * 62.4 * 1.3 = \mathbf{5,435 \text{ lb.}}$$

$$V_t = 500 \text{ gallons}$$

$$\gamma = 62.4 \text{ lb./ft.}^3 \text{ (fresh water)}$$

**FS** = 1.3 (This value should be verified with a geotechnical engineer familiar with local soil conditions)

**Step 2:** To determine the equivalent fluid weight of the earth over the tank and counterweight, a geotechnical engineer or other knowledgeable professional should be consulted. In general the following method is used to determine the weight of the soil:

$$\text{Volume of soil(ft.}^3\text{)} = \text{Tank area (as viewed from top)(ft.}^2\text{)} * \text{Depth of tank(ft.)}$$

$$\text{Tank area} = 4 * 5.5 = 22 \text{ ft.}^2$$

$$\text{Depth of soil over tank} = 6 - 4 \text{ (tank diam.[ft.])} - 1.5 \text{ (slab thickness[ft.])} = 0.5 \text{ ft.}$$

$$\text{Volume of soil over tank} = 22 * 0.5 + \left[ (22 * 2) - \left( \frac{3.14 * 2^2 * 5.5}{2} \right) \right] = 20.5 \text{ ft.}^3$$

$$\text{Density of saturated soil} = 106 \text{ lb./ft.}^3 \text{ (see Table 3.2.3.1A)}$$

$$\text{Weight of Earth over Tank} = 20.5 * 106 = 2,173 \text{ lb.}$$



**Step 3:** Next, **Net Buoyancy Force** should be calculated using *Formula 3.2.3.1B*.

$$\text{Net Buoyancy} = 5,435 - 650 - 2,173 = \mathbf{2,612 \text{ lb.}}$$

**Step 4:** After the net buoyancy force has been determined, *Formula 3.2.3.1C* can be used to determine either the number of straps or the required **Allowable Load** of each strap. In this example, the manufacturer determined the number and location of straps, so the allowable load will be determined.

$$\text{Allowable Load(lb.)} = \text{Net Buoyancy(lb.)/No. of Hold Down Straps Required.}$$

$$2,612 / 3 = \mathbf{871 \text{ lb./strap}}$$

Based on these calculations, the three straps should each be selected so that they have an allowable load of 871 pounds.

These calculations have all been based on the assumption that the concrete slab is heavy enough not to be lifted by the tank and straps. As a check, the weight of the tank and the equivalent fluid weight of any additional overbearing soil should be compared to the net buoyancy force to ensure that the buoyant tank will not lift the slab.

$$\text{Weight of the slab(lb.)} + \text{equivalent fluid weight of overbearing soil(lb.)} > \mathbf{\text{Net Buoyancy Force(lb.)}}$$

The weight of the counterweight slab is calculated using *Formula 3.2.1D*.

$$\text{Volume of slab(ft.}^3\text{)} = \text{Slab area (as viewed from top)(ft.}^2\text{)} * \text{Thickness of slab(ft.)}$$

$$\text{Slab area} = 4 * 5.5 = 22 \text{ ft.}^2$$

$$\text{Thickness of slab} = 1.5 \text{ ft.}$$

$$\text{Volume of slab} = 22 * 1.5 = 33 \text{ ft}^3$$

Density of concrete = 150 lb./ft.<sup>3</sup> (this must be verified by the local concrete supplier, aggregate densities can vary widely depending on source of the material)

$$\text{Weight of concrete slab} = 33 * 150 = 4,950 \text{ lb.}$$

As a check, compare the weight of the slab to the net buoyancy force, including a factor of safety.

$$4,950 \text{ lb.} > (2,612 * 1.3) = 3,396 \text{ lb.} \quad \checkmark$$

Therefore, the slab weighs enough to prevent the buoyant tank from lifting.



### 3.2.4 Fuel Lines, Gas Meters, Control Panels

Flood waters present the following dangers to fuel lines, gas meters, and control panels:

- In V Zones and A Zones subject to velocity flows, the forces of velocity flow and debris impact can break unprotected fuel pipes, particularly at the point of entry through the exterior wall of the building and/or the fuel tank structure.
- The forces of velocity flow can cause scour and soil erosion that would expose the fuel pipes going into the buildings they service. Once exposed, the pipes can be broken by debris impact and the forces of velocity flow. In addition, scour and erosion can undermine a building's foundation.
- Fuel leaking from broken fuel pipes into floodwaters will cause environmental contamination and create a fire hazard.
- The corrosive elements in flood waters can act upon unprotected fuel pipes causing rust and, eventually, perforation. Fuel from perforated pipes will leak out and contaminate the soil, groundwater, and flood waters.
- A typical natural gas meter is equipped with a relief valve or vent. Should the pressure relief valve or vent, or any control panel associated with it, become submerged during a flood, the valve might fail to operate properly, possibly resulting in a natural gas pressure surge entering a building.



#### **Elevation**

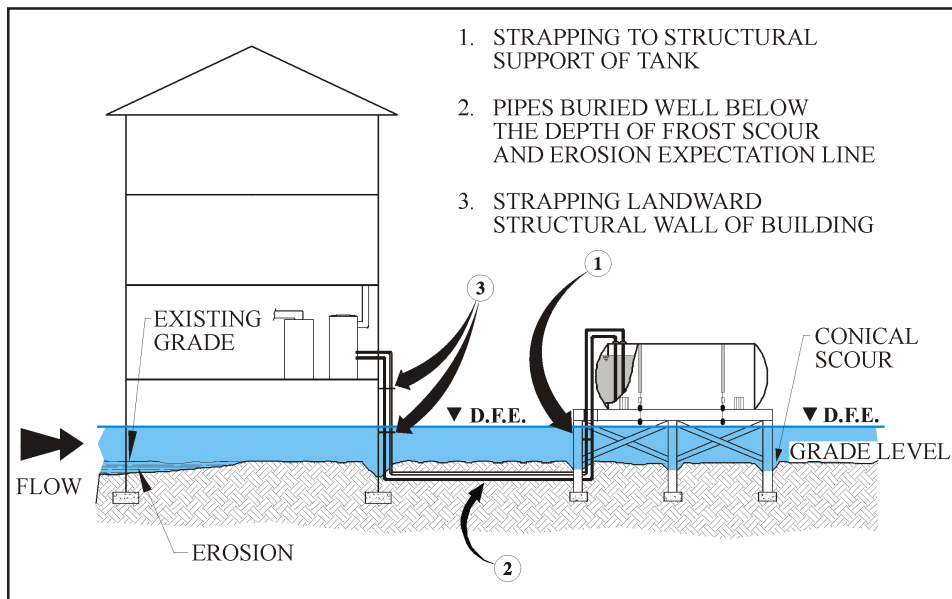
In order to prevent fuel lines from breaking at wall penetration points as a result of velocity flow, the fuel pipes should be designed to penetrate walls above the DFE. Ideally, each fuel line should be kept completely above the DFE.

As with electrical meters, utility companies should be encouraged to elevate gas meters and controls above the DFE. Should this not be practical, the vent opening can be extended above the DFE through the use of a standpipe attached to the meter vent. An elevated gas meter with controls can be made accessible by providing steps below the meter, or by locating the meter on a deck above the DFE with access to the deck from ground level.



### Component Protection

Where it is not possible to elevate the whole length of a fuel line above the DFE, the pipe can be protected by strapping it to the landward downstream side of the vertical structural member, as shown in *Figure 3.2.4A*.



**NOTE:**  
For clarity, the utility connections have been shown on the exterior of the building. For maximum protection of the utility connection, it should be located adjacent to a vertical member underneath the building.

Figure 3.2.4A: The vertical runs of fuel piping strapped against vertical non-breakaway structures

In coastal areas the straps must be composed of non-corrosive materials.

An alternative protection method for fuel lines is to enclose the vertical fuel line that exits from the protective wall around the tank within a utility shaft. The vertical pipe that enters into the structure should also be enclosed in a utility shaft. The protective shafts can either be made of concrete, metal, or rigid plastic pipe, and they must extend above the DFE. If the shaft is not watertight, drainage holes should be provided at the base of the shaft. *Figure 3.2.4B* shows an exterior elevated fuel tank and the associated piping.

The underground horizontal pipe run must be below the frost line and the expected line of scour and erosion in V Zones. Since flood-damaged fuel tanks have proven to be a significant source of potential environmental risk,



## New and Substantially Improved Buildings Fuel Systems

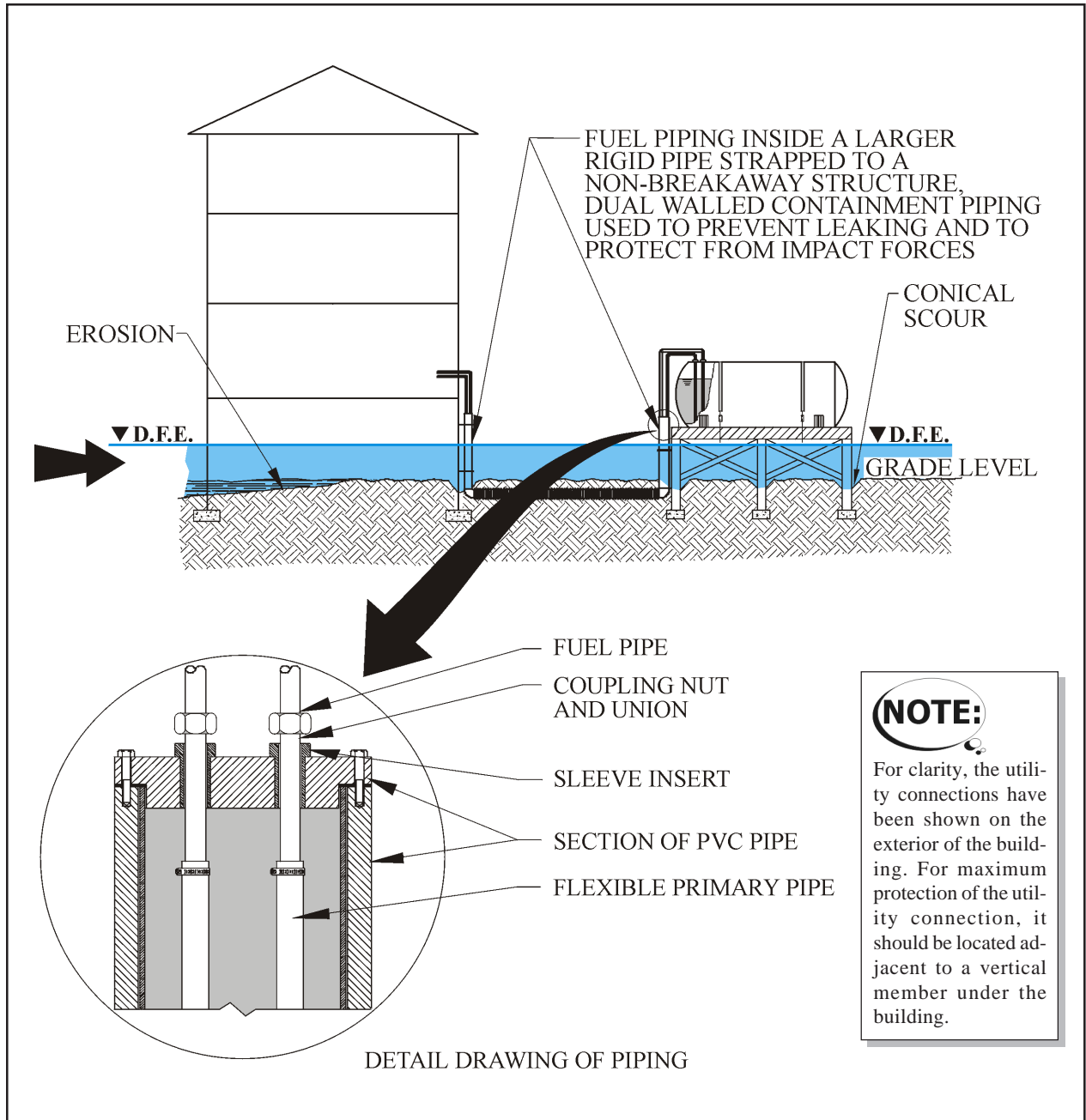


Figure 3.2.4B: The vertical runs of fuel piping embedded in utility shafts strapped to non-breakaway structures

## New and Substantially Improved Buildings Fuel Systems



compliance with applicable federal, state, and local regulations is essential. As a result of stringent Environmental Protection Agency monitoring of commercial and non-residential fuel system installations, many manufacturers currently produce watertight fuel system components (tanks and piping) with secondary containment designs. Secondary containment designs are also highly recommended for residential fuel systems.

It is important that fuel piping have some flexibility. During a flood, uneven settlement of a structure can occur due to soil saturation. Such movement can cause the rigid, metallic pipe connections to the tank and through the exterior wall of the building to break off.

Fuel line wall penetrations that are located below the DFE must be properly designed to permit movement of the line while keeping the building watertight. It should also be noted that standard vertical and horizontal penetrations are typically of differing designs and one may be more applicable to certain uses than others. Refer to local code officials regarding the proper use of wall penetration sealant.

### 3.2.5 Conclusion

The following figure and table have been provided which summarize the overall design approach for flood resistant fuel systems in new and substantially improved buildings. *Figure 3.2.5* is a flow chart that outlines the steps involved in the design of a flood resistant fuel system. *Table 3.2.5* is a checklist to aid in the review of proposed designs or existing systems for compliance with Federal, State, and local regulations. In addition, a sketch sheet is included so that the locations or details of the system can be noted. The tables are intended to assist designers and building officials in providing the most effective level of flood protection for fuel system components.

#### NOTE:

Fuel lines located below the DFE should be equipped with automatic shut-off valves to prevent loss of fuel in the event of a line breakage or disconnection from the fuel tank.





## New and Substantially Improved Buildings Fuel Systems

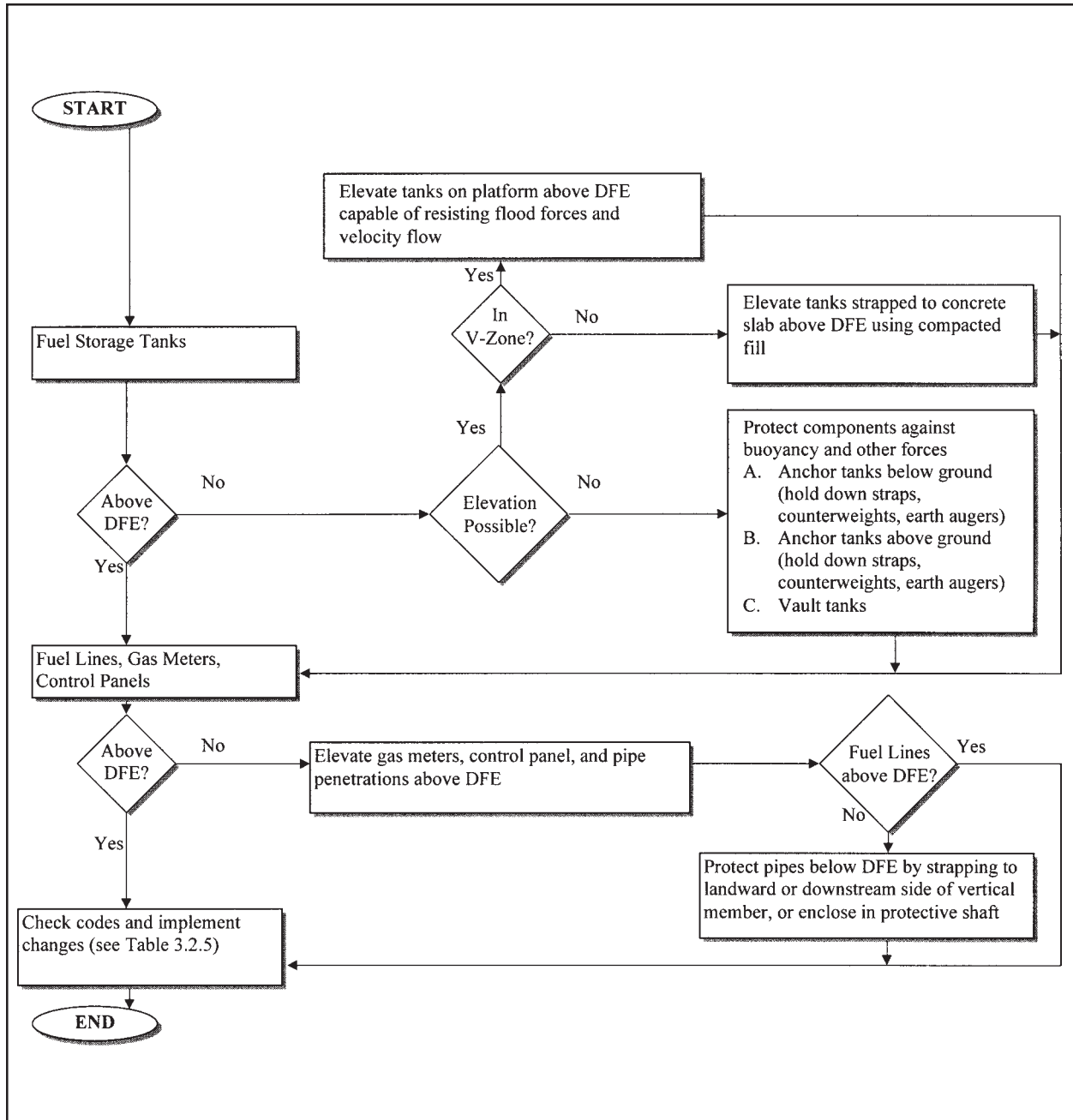


Figure 3.2.5: Flow chart of flood resistant fuel system design

## New and Substantially Improved Buildings Fuel Systems



### FLOOD RESISTANT FUEL SYSTEM CHECKLIST

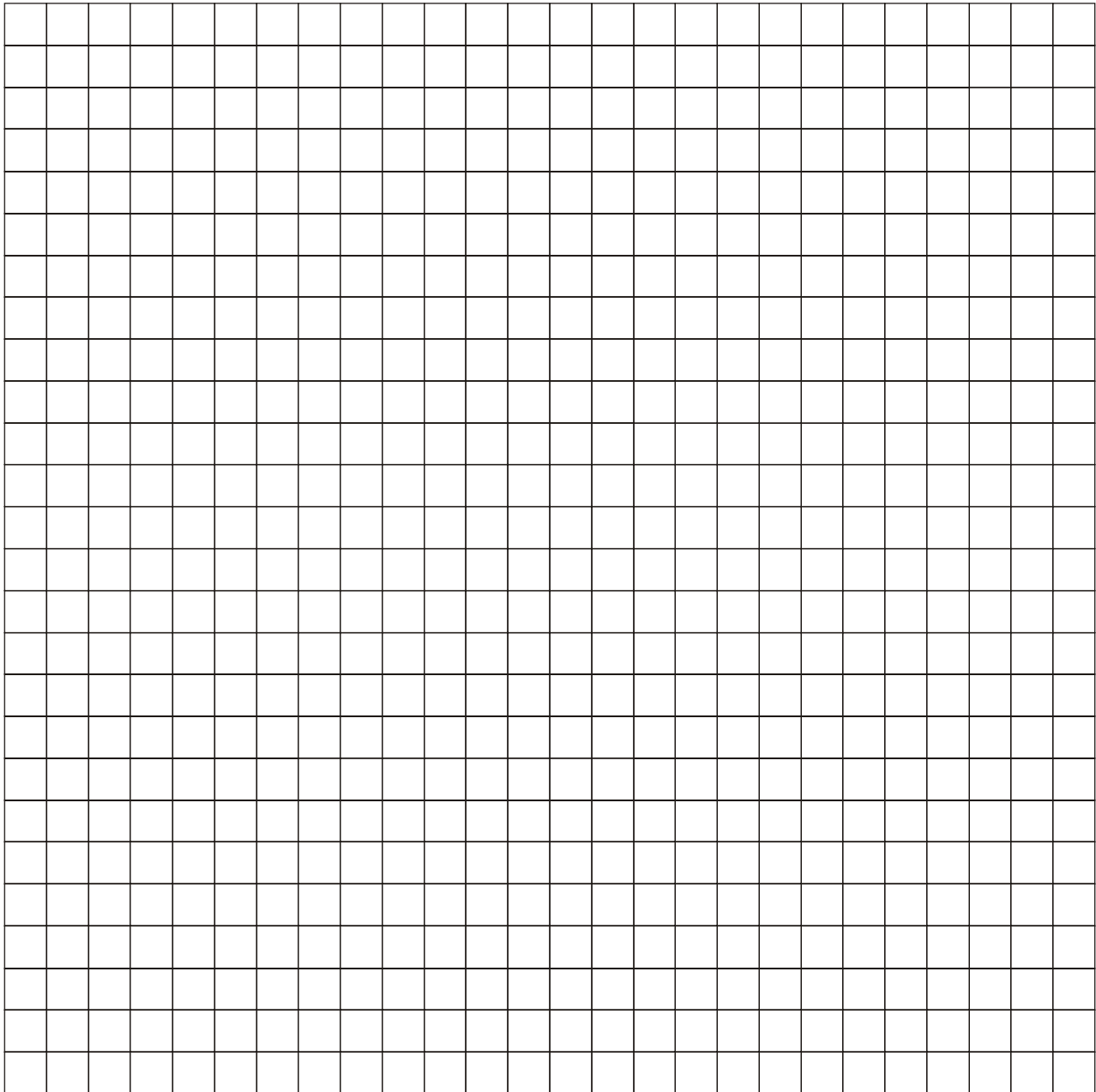
Property ID:		Property Contact:	
Property Name:		Interviewed:	
Property Address:		Phone:	
Surveyed By:		Date Surveyed:	
DFE:			
<ul style="list-style-type: none"> <li>What type of fuel system supplies the building?</li> </ul>			
<input type="checkbox"/> Above ground Is tank anchored to the ground properly? <input type="checkbox"/> Y <input type="checkbox"/> N Are fuel lines protected from impact? <input type="checkbox"/> Y <input type="checkbox"/> N Is the tank support structure designed to handle velocity flow? <input type="checkbox"/> Y <input type="checkbox"/> N		<input type="checkbox"/> Below ground Is tank protected from buoyancy forces properly? <input type="checkbox"/> Y <input type="checkbox"/> N Is the fuel tank top protected from impact? <input type="checkbox"/> Y <input type="checkbox"/> N Are fuel lines protected from impact? <input type="checkbox"/> Y <input type="checkbox"/> N	
<input type="checkbox"/> Inside the building Is tank anchored to the floor properly? <input type="checkbox"/> Y <input type="checkbox"/> N Are tank and fuel lines protected from impact? <input type="checkbox"/> Y <input type="checkbox"/> N Is the tank properly distanced from the wall and ignition sources? <input type="checkbox"/> Y <input type="checkbox"/> N		<input type="checkbox"/> Natural Gas Line Is the incoming natural gas line protected from impact? <input type="checkbox"/> Y <input type="checkbox"/> N What type of gas line is used? Is the gas meter protected from inundation by floodwaters? <input type="checkbox"/> Y <input type="checkbox"/> N	
Is a fuel storage tank located at the building? <input type="checkbox"/> Y <input type="checkbox"/> N: What type of fuel does it contain?			
Is the fuel storage tank of double-walled design? <input type="checkbox"/> Y <input type="checkbox"/> N			
Describe the tank anchoring system:			
Is the fuel system venting extended to above the DFE? <input type="checkbox"/> Y <input type="checkbox"/> N			
<ul style="list-style-type: none"> <li>What components are located below the DFE?</li> </ul>			
<input type="checkbox"/> Tank	<input type="checkbox"/> Fuel Lines	<input type="checkbox"/> Gas Meters	<input type="checkbox"/> Other: <input type="checkbox"/> Other:

Table 3.2.5: Checklist for flood resistant fuel system design



**New and Substantially Improved Buildings**  
**Fuel Systems**

**Sketch sheet**  
**(for details, notes, or data regarding system installations)**



**CONTENTS**

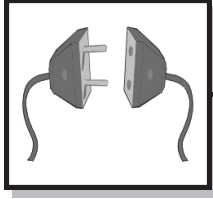
	<b>Page</b>
<b>3.3 Electrical Systems</b>	<b>3.3-2</b>
<b>3.3.1 Introduction</b>	<b>3.3-2</b>
<b>3.3.2 NFIP Requirements</b>	<b>3.3-4</b>
<b>3.3.3 Power-Handling Equipment</b>	<b>3.3-4</b>
<b>3.3.4 Control and Utilization Equipment</b>	<b>3.3-7</b>
<b>3.3.5 Wiring</b>	<b>3.3-9</b>
<b>3.3.6 Conclusion</b>	<b>3.3-12</b>

**FIGURES**

<b>Figure 3.3.1A: Typical electrical system configuration in a commercial application</b>	<b>3.3-3</b>
<b>Figure 3.3.1B: Typical electrical system configuration in a residential application</b>	<b>3.3-3</b>
<b>Figure 3.3.3: Structure with electrical components located above the DFE</b>	<b>3.3-6</b>
<b>Figure 3.3.5A: Structure with underground electrical feed wire</b>	<b>3.3-11</b>
<b>Figure 3.3.5B: Structure with electrical components located below the DFE</b>	<b>3.3-12</b>
<b>Figure 3.3.6: Flow chart of flood resistant electrical system design</b>	<b>3.3-14</b>

**TABLES**

<b>Table 3.3.2: Summary of NFIP regulations</b>	<b>3.3-4</b>
<b>Table 3.3.5: Characteristics of insulated wires (conductors)</b>	<b>3.3-10</b>
<b>Table 3.3.6: Checklist for flood resistant electrical system design</b>	<b>3.3-15</b>



## 3.3 Electrical Systems

### 3.3.1 Introduction

**NOTE:**

Chapter 2 contains additional information pertaining to flood damaged electrical systems.

A building's electrical system can be divided into three components:

1. Power-Handling Equipment
2. Control and Utilization Equipment
3. Wiring

**Power-handling Equipment** generally consists of bare, weatherproof, or pre-assembled cables, direct-buried or raceway-installed underground cables, transformers, switchboards, meters, distribution panels, large switches, and circuit breakers.

**Control and Utilization Equipment** generally consists of the various lighting components in a building, and the motors, controls, and wiring devices (i.e., receptacles, switches, dimmers, etc.) used to activate and control such components.

**Wiring** generally consists of all types of conductors and raceways that are used to provide the interior and exterior electrical wiring needs of a building. An interior wiring system is typically comprised of exposed insulated cables, insulated cables in open raceways, insulated conductors in closed raceways, and combined conductor and enclosure.

*Figures 3.3.1A and 3.3.1B* show the typical components of commercial and residential electrical systems. They differ in the size of the service provided as well as the voltage. For commercial buildings, additional components are required to properly regulate the service.

This chapter discusses how to protect electrical systems and components from flood damage under the National Flood Insurance Program (NFIP). Inundation of electrical equipment in a building creates the danger of short circuits, electrical shock, damage of electric components and appliances, injury, fire or even death. In coastal areas, salt water can also cause corrosion that can severely damage electrical components.

**NOTE:**

This chapter applies to new and substantially improved structures that must be built in compliance with the minimum requirements of the NFIP. Many of the structures that were built prior to the adoption of floodplain management regulations by communities have building utility systems that are not resistant to flood damages. For additional information on how to protect building utility systems in these structures, see Chapter 4 on Existing Buildings.

## New and Substantially Improved Buildings Electrical Systems

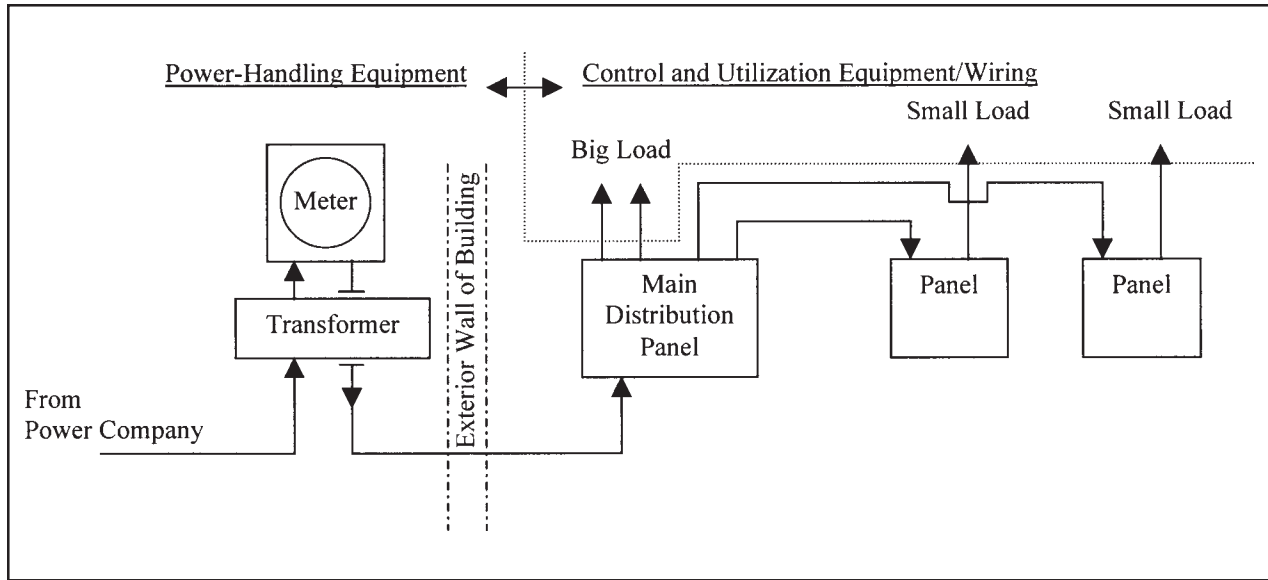
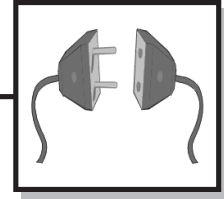


Figure 3.3.1A: Typical electrical system configuration in a commercial application

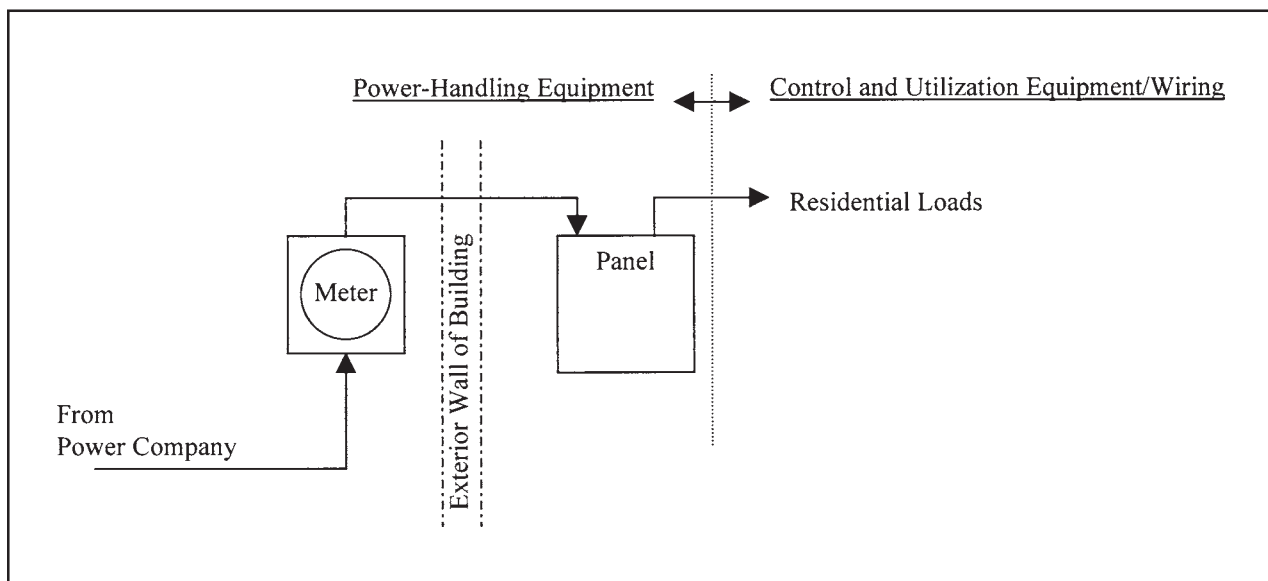
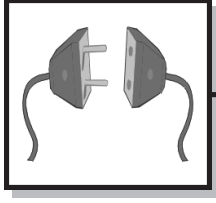


Figure 3.3.1B: Typical electrical system configuration in a residential application



## New and Substantially Improved Buildings Electrical Systems

Since contact of live electrical components with water can result in injury or extreme damage, it is best to keep floodwaters from reaching any electrical component.

In general, the figures in this chapter attempt to illustrate some general practices that meet the requirements of the NFIP. Local codes permit many variations that also meet NFIP regulations. Please refer to your local code officials for specific practices that may meet both NFIP regulations and local code.

### 3.3.2 NFIP Requirements

The NFIP requires that the electrical system in a new or substantially improved structure located in a Special Flood Hazard Area (SFHA) be designed so that floodwaters cannot infiltrate or accumulate within any component of the system. See *Table 3.3.2* for a summary of compliant mitigation methods.

Methods of Mitigation	A Zones	V Zones
1. Elevation	Highly Recommended	Minimum Requirement
2. Component Protection	Minimum Requirement	Not Allowed*

**Table 3.3.2: Summary of NFIP regulations**

\*Allowed only for those items required to descend below the DFE for service connections.

#### **NOTE:**

The Design Flood Elevation (DFE) is a regulatory flood elevation adopted by a community that is the BFE, at a minimum, and may include freeboard, as adopted by the community.

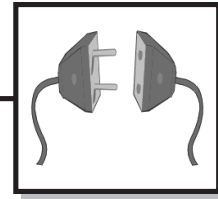
1. **Elevation** refers to the location of a component above the Design Flood Elevation (DFE).
2. **Component Protection** refers to the implementation of design techniques that protect a component or group of components located below the DFE from flood damage by preventing floodwater from entering or accumulating within the system components.

### 3.3.3 Power-Handling Equipment

Power handling equipment in residential applications typically consists of meters, distribution panels, large switches and circuit breakers. These items are the largest components of the electrical system and are typically the most



## New and Substantially Improved Buildings Electrical Systems



expensive to replace. In addition, these components typically provide the link between the electric service provider and the building. Therefore, the protection of these components is particularly important. Power handling equipment in commercial applications typically consists of the same components that are used in residential applications, but additional switches, distribution panels, and even transformers may be added to regulate the larger demand.

### Elevation

The most effective flood-resistant design of electrical systems in new and substantially improved buildings in flood-prone areas is elevation of all electrical components to levels at or above the DFE. Elevation gives the most assurance possible that, during a flood, the electrical system components would not be inundated by floodwaters. *Figure 3.3.3* shows a residential structure with electrical components located above the DFE.

In some situations, the maximum elevation of a component, relative to the floor, is specified. If a component cannot be located above the DFE without exceeding the maximum elevation stipulated by code, it must be relocated to a higher floor within the structure. Or, as an alternative, installation of a platform with stairs to provide access to the elevated electrical components may also meet local code requirements.

### Relocation

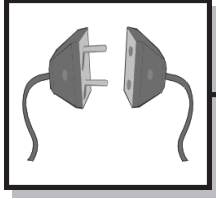
If raising the equipment above the DFE is not practical, the power handling equipment can be moved to a utility shed that is above the DFE. Relocation of the equipment is an expensive option, but it can be effective in providing elevation of all the equipment. It is used in substantially damaged/improved structures where there is no room to relocate all the electrical equipment and appliances into the main structure above the DFE. In order to elevate the equipment above the DFE a separate structure is built just for housing the electrical equipment. From the separate structure a line is run into a breaker box located in the main structure. The connecting cable between the substructure and the main structure must be above the DFE.

### Component Protection

If it is not possible or practical to raise power-handling equipment above the DFE, measures can be taken to protect the equipment at elevations below



The National Electric Code (NEC) specifies a maximum elevation of electric components of 6½ feet above the floor. Refer to your local code officials for similar elevation restrictions.



## New and Substantially Improved Buildings Electrical Systems

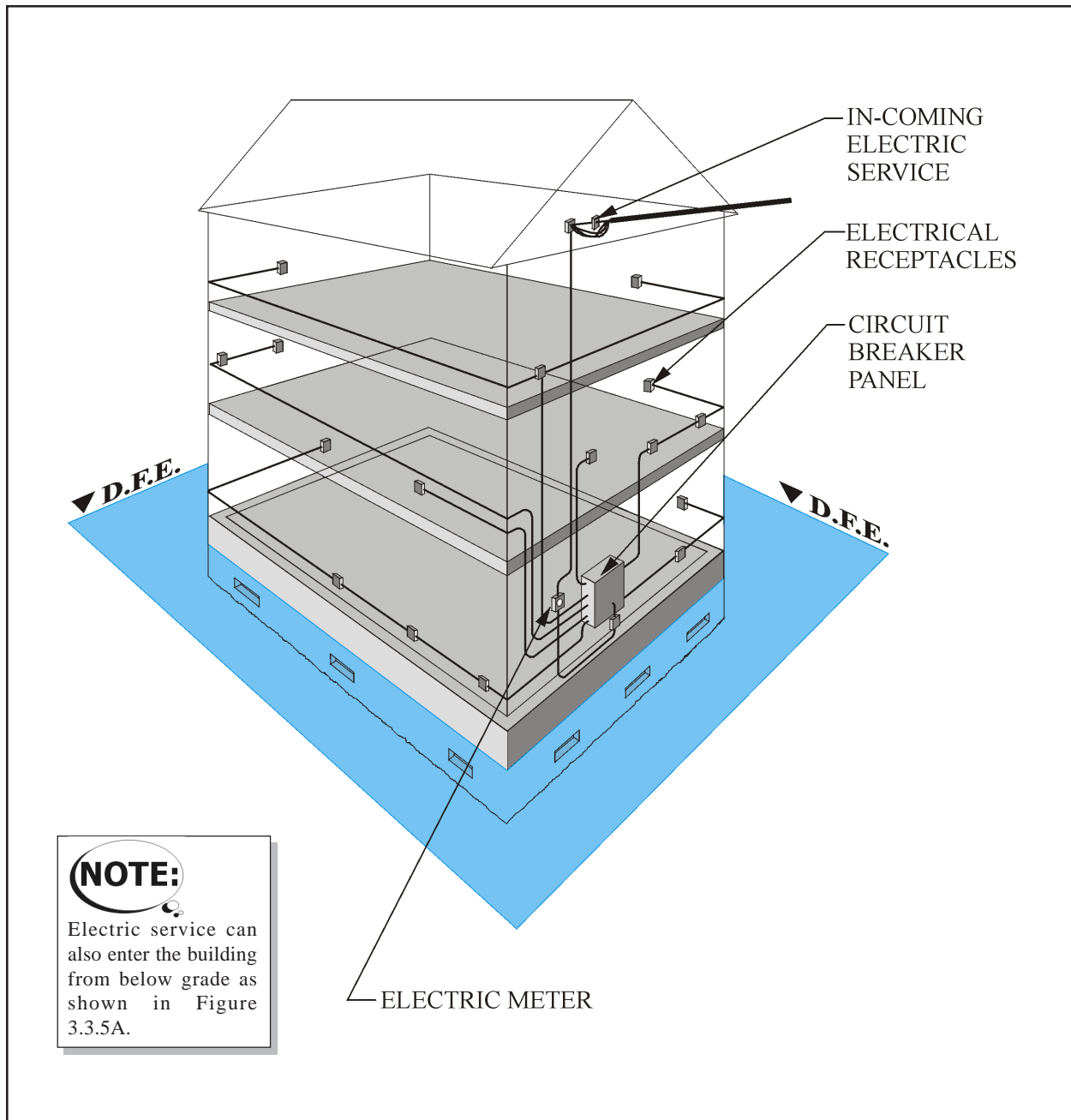
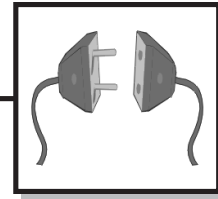


Figure 3.3.3: Structure with electrical components located above the DFE

## New and Substantially Improved Buildings Electrical Systems



the DFE. For example, a watertight enclosed wall can be built around the electrical equipment that is located below the DFE. The top of the enclosure must be at or above the DFE and there must be a watertight access to the equipment for maintenance.

If electrical components that are supplied power by the distribution panel must remain below the DFE, they can be isolated using the distribution panel. The only electrical components that are permitted below the DFE are the minimum necessary for life/safety. Examples include smoke detectors, simple light fixtures, and switches and receptacles required for areas used for building access, parking, or storage. This design approach groups all of the components that lie beneath the DFE together on Ground Fault Interrupting Circuit (GFIC) breakers. These breakers should be clearly marked so that they can be disconnected in the event of rising floodwaters. This approach leaves other portions of the electrical system to function normally.

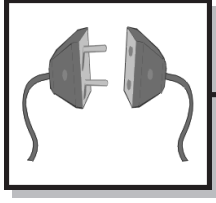
The major component that a building owner may not be able to properly locate above the DFE is the meter. Often utility companies want the meter located close to the ground so it is readily accessible for their inspection. Consult the local electrical utility company. Determine if the local electrical utility will permit the meter to be elevated above the DFE with access provided by a stairway and platform. If the company does not permit this, the meter can be located below the DFE, but must be elevated as high as the company permits.

### 3.3.4 Control and Utilization Equipment

Control and utilization equipment in residential applications generally consists of receptacles, switches, and lighting components. In typical applications, control and utilization equipment will not come in contact with floodwaters because the NFIP requires that the lowest floor elevation be above the DFE. However, exceptions arise in situations where access to an elevated structure requires lighting fixtures/switches below the DFE. The utmost care must be taken to protect life and property in situations where equipment is located below the DFE. This section discusses some basic concepts related to control and utilization equipment as well as guidelines regarding floodproofing of the equipment.

#### **NOTE:**

All electrical equipment located below the DFE should be on separate Ground Fault Interrupting Circuits clearly marked on the breaker box. This makes it easy to shut off power to all the equipment below the DFE in case of a flood.



## New and Substantially Improved Buildings Electrical Systems

Standard duplex receptacles consist of two sockets, each accommodating a standard plug. In new installations, the three-slot grounded versions of these receptacles are required. Larger appliances sometimes require receptacles rated for additional voltage and amperes. The needs of the equipment that are to be powered dictate the type of plug that is used. If equipment must be located below the DFE, equipment of the lower voltage and amperage types should be used.

Standard wall switches typically control lower voltage applications and could therefore be used below the DFE to control code-required lighting fixtures. Devices that require larger voltages are typically wired directly to the distribution panel and controlled by the associated circuit breaker and need to be located above the DFE.

Residential lighting applications typically use standard voltage. Some commercial lighting applications, particularly fluorescents, use higher voltages. If codes specify that lighting must be provided in areas that are below the DFE, care should be taken to ensure that only low voltage (120V or less)/low amperage fixtures be used. They should be regulated by a GFI breaker that can be used to isolate the circuit in the event of flood conditions.

Wall switches, receptacles, and lighting components are typically interconnected using electric junction boxes and pressure connections. In flood-prone areas, these boxes should be constructed of non-corrosive materials and located above the DFE.

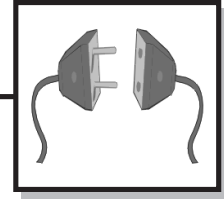
Some equipment is commercially available for marine applications. Depending on the design of the particular unit, it may not be designed to allow proper drainage and drying. If receptacles or light switches must be located below the DFE, they should be of the standard type and, as mentioned elsewhere in this section, will need to be replaced after inundation by floodwaters. This equipment is permitted below the DFE only to the extent required by code for life/safety.



### **Elevation**

As with all electrical components, the optimal approach when designing an electrical system is to locate all components above the DFE. All attempts

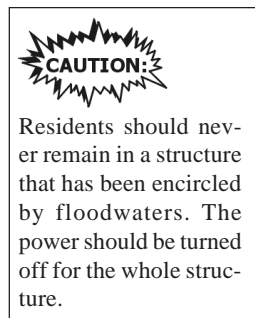
## New and Substantially Improved Buildings Electrical Systems



should be made to raise control and utilization equipment above the DFE. However, if this is not possible due to local code requirements, then the minimum necessary receptacles, switches, lights, and other components are permitted to be located below the DFE. The distribution panel shall be located above the DFE unless protected from floodwaters entering or accumulating within the panel box.

### Component Protection/Isolation

If control and utilization equipment must remain below the DFE, it should be isolated using the distribution panel. The components that lie beneath the DFE should be grouped together on GFIC breakers. In addition, these breakers should be clearly marked so that they can be disconnected in the event of rising floodwaters. This approach leaves other portions of the electrical system to function normally after the portions of the electrical system below the DFE have been disconnected for post-flooding examination and replacement of inundated components.

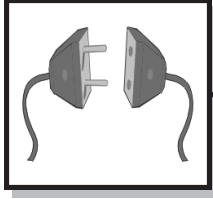


### 3.3.5 Wiring

Wiring are the conveyance lines between the source of energy supply and the equipment that needs the electric energy supply. Most private residential wiring is of type TW Thermoplastic insulated weather resistant or type THW that is both heat and weather resistant. *Table 3.3.5* shows the characteristics of insulated wires (conductors). Any of the wires rated for wet locations are permitted for installation below the DFE.

Individual circuit wire may run through metal or plastic pipes called conduits. More often, circuit wires are combined into cables. Such cables can be either non-metallic sheathed cable (Type NM) or steel armored cable (Type AC). The steel armored cable is usable only in dry indoor locations and is not permitted for installation below the DFE.

Wire connections are typically made with twist-on insulated connectors frequently called wire nuts. The general term for pressure-type connectors, such as wire nuts, is solderless connectors. Pressure connections are adequate for most applications.



## New and Substantially Improved Buildings Electrical Systems

Trade Name	Type Letter	Maximum Operating Temperature	Application Provisions
Moisture and heat-resistant rubber	RHW*	75C 167F	Dry and wet locations
Thermoplastic	T	60C 140F	Dry locations
Moisture-resistant thermoplastic	TW*	60C 140F	Dry and wet locations
Heat-resistant thermoplastic	THHN	90C 194F	Dry locations
Moisture and heat-resistant thermoplastic	THW*	75C 167F	Dry and wet locations
Moisture and heat-resistant thermoplastic	THWN	75C 167F	Dry and wet locations
Moisture and heat-resistant cross-linked thermosetting polyethylene	XHWN*	90C 194F	Dry locations
		75C 167F	Wet locations
Silicone-asbestos	SA	90C 194F	Dry locations
Asbestos and varnished cambric	AVA	110C 230F	Dry locations only

**Table 3.3.5: Characteristics of insulated wires (conductors)**

Source: Extracted from the National Electrical Code

\*Suitable for Flood Zones

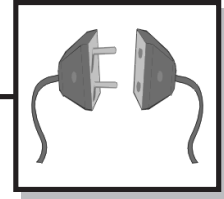


### Elevation and Component Protection

As with power handling equipment, the optimum choice when designing a wiring scenario for a building is to locate all wiring above the DFE, as was shown in Figure 3.3.3. However, in some developments, the wiring that services the buildings is routed underground. In this case, keeping the wiring above the DFE is not possible. The conduit should be of a watertight type and extend above the DFE before the wiring is released from the conduit. *Figure 3.3.5A* shows a residential structure with an underground electrical feed wire. Notice that the underground feed extends vertically above the DFE before the watertight conduit is breached. In addition, the top of the conduit is protected to prevent the infiltration of rain.

In some circumstances the wiring enters the house above the DFE but distribution wiring must extend below the DFE. *Figure 3.3.5B* shows an example

## New and Substantially Improved Buildings Electrical Systems



where distribution wiring may be required to extend below the DFE. In situations where wiring must be extended below the DFE, the wiring should be encased in non-corrosive conduit. The conduits should be installed vertically to promote thorough drainage when the floodwaters recede. Wiring should be installed in conduits in these applications because it is easier to replace wiring that is damaged by floodwaters if it is installed in conduit.

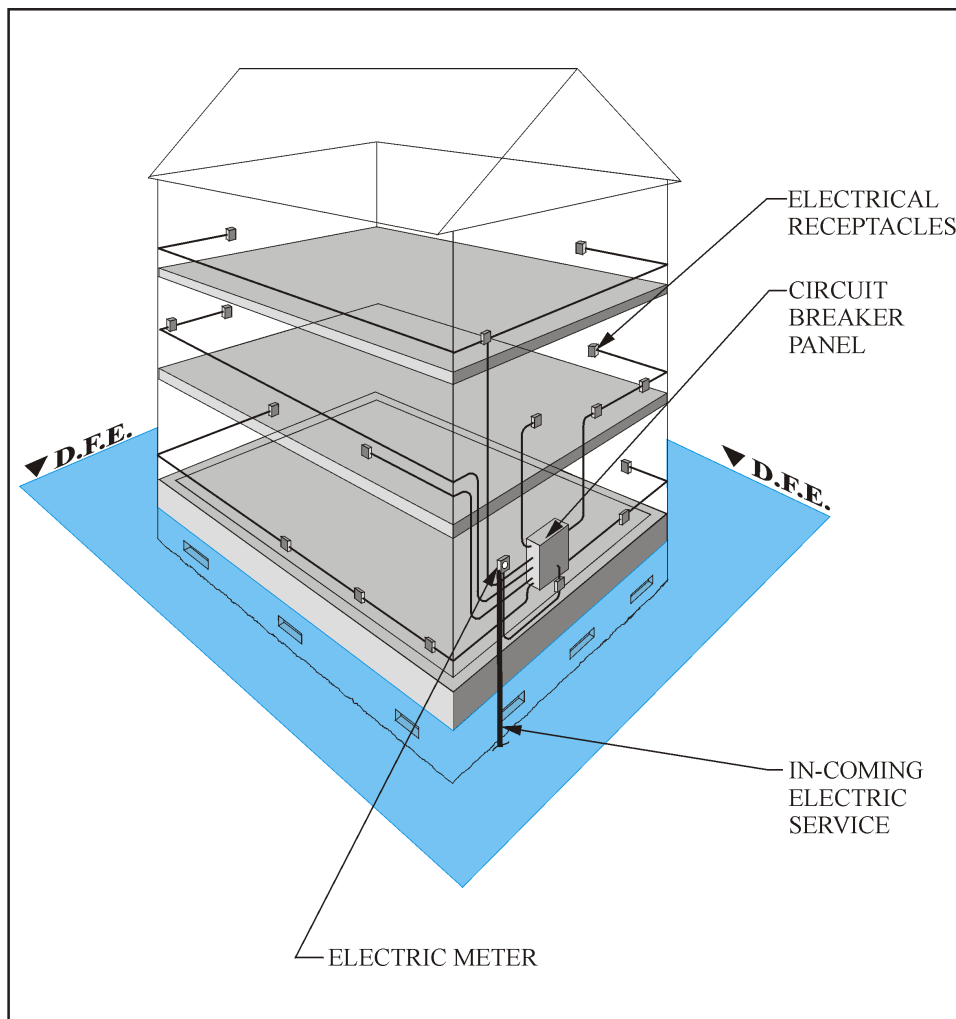
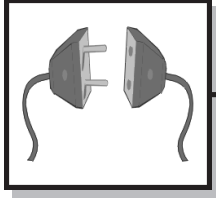


Figure 3.3.5A: Structure with underground electrical feed wire





## New and Substantially Improved Buildings Electrical Systems

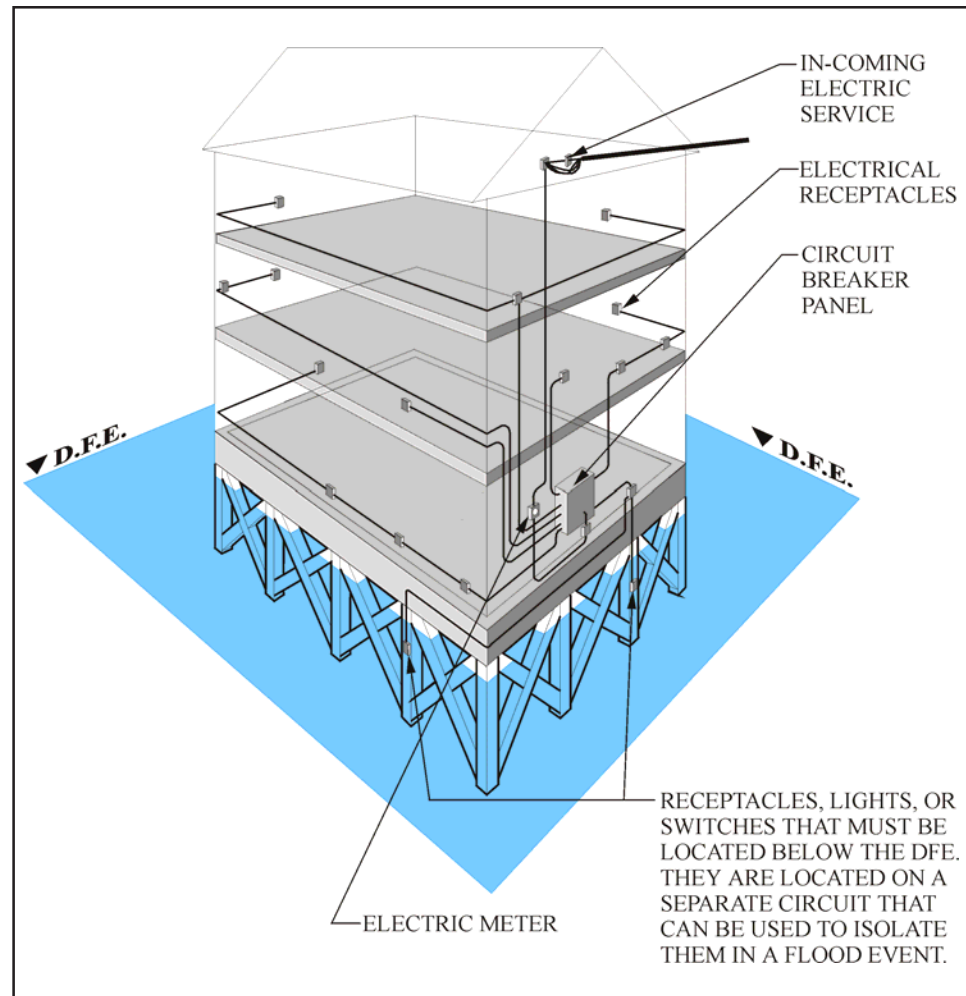
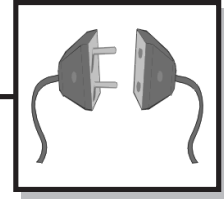


Figure 3.3.5B: Structure with electrical components located below the DFE

### 3.3.6 Conclusion

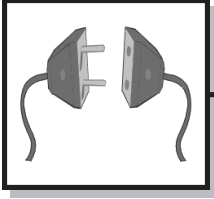
Generally speaking, the best approach to minimizing the flood damage to the electrical system of a building is to raise all of the electrical components above the DFE. If the larger components of the structure cannot be relocated to higher elevations, measures can be taken to protect them in place. As a last resort, if some of the smaller components of the system cannot be ele-

## New and Substantially Improved Buildings Electrical Systems



vated above the DFE due to local code requirements, design methods can be utilized to minimize the flood damage to the electrical systems of the building so that it can be reoccupied as quickly as possible.

When the electrical system of a building is properly protected from flood damage, the structure can be brought back into operating order more quickly. *Figure 3.3.6* is a flow chart designed to assist you with the design of flood-resistant electrical systems in new and substantially improved buildings. *Table 3.3.6* is a checklist to aid in the review of proposed designs or existing systems for compliance with Federal, State, and local regulations. In addition, a sketch sheet is included that can be used to make additional notes about the system. With a proper assessment of a building and some careful planning before a flooding event occurs, the damage to the building's electrical system can be minimized or eliminated.



## New and Substantially Improved Buildings Electrical Systems

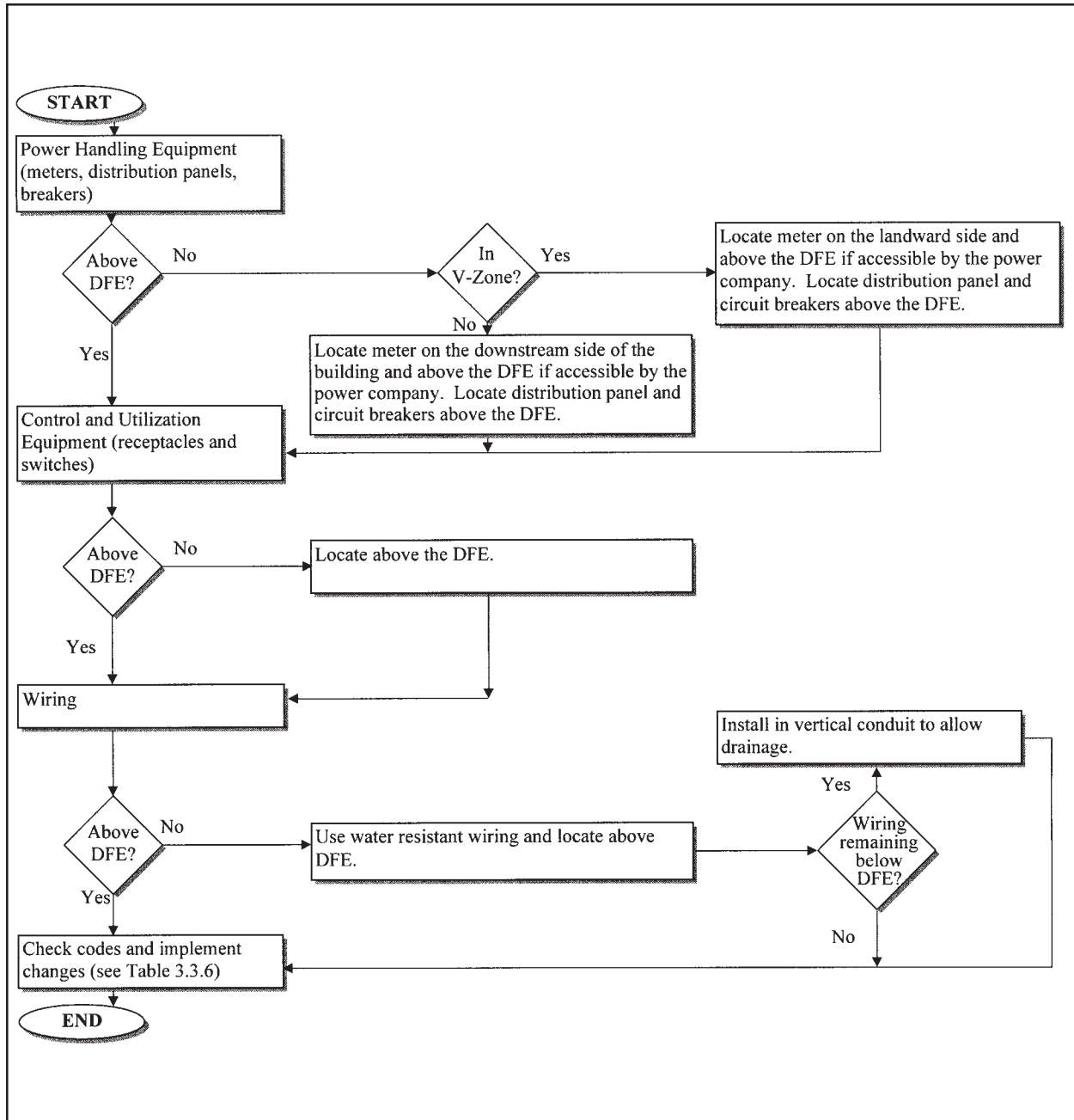
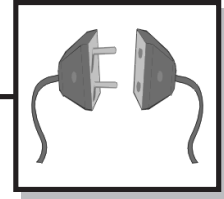


Figure 3.3.6: Flow chart of flood resistant electrical system design

## New and Substantially Improved Buildings Electrical Systems



### FLOOD RESISTANT ELECTRICAL SYSTEM CHECKLIST

Property ID:		Property Contact:	
Property Name:		Interviewed:	
Property Address:		Phone:	
Surveyed By:		Date Surveyed:	
BFE:			
• How Does the Electric service approach the building?			
<input type="checkbox"/> Underground		<input type="checkbox"/> Pole Mounted	
Description:			
• Where is the Electric Meter Located? Elevation:			
<input type="checkbox"/> North Side	<input type="checkbox"/> South Side	<input type="checkbox"/> East Side	<input type="checkbox"/> West Side
Description:			
• How does the electric service enter the building? Elevation:			
Description:			
• Where is the distribution panel? Elevation:			
Description:			
Are the breakers serving circuits below the DFE Ground Fault Interrupting Circuits? <input type="checkbox"/> Yes <input type="checkbox"/> No			
• What equipment is located beneath the DFE?			
<input type="checkbox"/> Meter	<input type="checkbox"/> Distribution Panel	<input type="checkbox"/> Lighting	<input type="checkbox"/> Receptacles
<input type="checkbox"/> Wiring	<input type="checkbox"/> Service Entrance		
<input type="checkbox"/> Other:		<input type="checkbox"/> Other:	<input type="checkbox"/> Other:
• What type of internal wiring was observed?			
<input type="checkbox"/> RHW	<input type="checkbox"/> T	<input type="checkbox"/> TW	<input type="checkbox"/> THHN
<input type="checkbox"/> THW	<input type="checkbox"/> THWN	<input type="checkbox"/> XHWN	<input type="checkbox"/> SA
<input type="checkbox"/> AVA			

Table 3.3.6: Checklist for flood resistant electrical system design



## **CONTENTS**

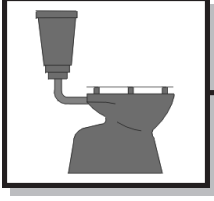
	<b>Page</b>
<b>3.4 Sewage Management Systems</b>	<b>3.4-2</b>
<b>3.4.1 Introduction</b>	<b>3.4-2</b>
<b>3.4.2 NFIP Regulations</b>	<b>3.4-4</b>
<b>3.4.3 Treatment/Disposal Components</b>	<b>3.4-4</b>
<b>3.4.4 Collection Components</b>	<b>3.4-16</b>
<b>3.4.5 Conclusion</b>	<b>3.4-22</b>

## **FIGURES**

<b>Figure 3.4.3A: The components of a public sewage management system in a velocity flow area</b>	<b>3.4-6</b>
<b>Figure 3.4.3B: The components of a public sewage management system in a non-velocity flow area</b>	<b>3.4-7</b>
<b>Figure 3.4.3C: The components of a typical on-site sewage management system in a velocity flow area</b>	<b>3.4-8</b>
<b>Figure 3.4.3D: The components of a typical on-site sewage management system in a non-velocity flow area</b>	<b>3.4-9</b>
<b>Figure 3.4.3E: Components of a typical "overhead sewer"</b>	<b>3.4-11</b>
<b>Figure 3.4.3F: Examples of an expansive rubber wall or floor penetration seal</b>	<b>3.4-13</b>
<b>Figure 3.4.3G: Sealed septic tank with lid and access cover</b>	<b>3.4-13</b>
<b>Figure 3.4.3H: An on-site sewage management system using an elevated treatment tank within a V Zone</b>	<b>3.4-15</b>
<b>Figure 3.4.4A: Backflow conditions with non-return backflow valve installed</b>	<b>3.4-18</b>
<b>Figure 3.4.4B: Backflow valve—a check valve and gate valve with an effluent pump bypass</b>	<b>3.4-19</b>
<b>Figure 3.4.4C: A service connection pipe strapped to a pile</b>	<b>3.4-21</b>
<b>Figure 3.4.4D: A service connection pipe enclosed in a utility shaft</b>	<b>3.4-21</b>
<b>Figure 3.4.4E: Top view of utility shaft made of metal framing with cement board and stucco</b>	<b>3.4-22</b>
<b>Figure 3.4.5A: Flow chart of on-site flood resistant sewage management system design</b>	<b>3.4-24</b>
<b>Figure 3.4.5B: Flow chart of off-site flood resistant sewage management system design</b>	<b>3.4-25</b>

## **TABLES**

<b>Table 3.4.2: Summary of NFIP regulations</b>	<b>3.4-4</b>
<b>Table 3.4.5A: Checklist for on-site flood resistant sewage management system design</b>	<b>3.4-26</b>
<b>Table 3.4.5B: Checklist for off-site flood resistant sewage management system design</b>	<b>3.4-27</b>



## New and Substantially Improved Buildings Sewage Management Systems

### 3.4 Sewage Management Systems

#### 3.4.1 Introduction

Sewage management systems for buildings can be arranged into two components:

1. Treatment/Disposal Components
2. Collection Components

#### **(NOTE:**

This chapter applies to new and substantially improved structures that must be built in compliance with the minimum requirements of the NFIP. Many of the structures that were built prior to the adoption of floodplain management regulations by communities have building utilities systems that are not resistant to flood damages. For additional information on how to protect building utility systems in these structures, see Chapter 4 on Existing Buildings.

**Treatment/Disposal Components** can include either an off-site or an on-site system that is used to temporarily store or treat the sewage. Some examples of these components are:

- Public sewer system
- Septic system
- Elevated storage tank

**Collection Components** generally include the drains in the toilets, floors, urinals, bathtubs, showers, sinks, and building interior piping.

For a sewage management system that discharges into a public facility, only the on-site portion of the system is covered in this manual.

In general, the figures in this chapter attempt to illustrate some general practices that meet the requirements of the National Flood Insurance Program (NFIP). Local codes permit many variations that also meet NFIP regulations. Please refer to any state and local code officials for specific practices that may meet both NFIP and other requirements.

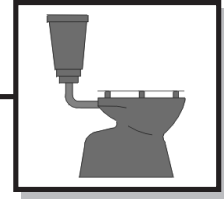
#### **General Sewage Management System Hazards**

Floodwaters present three main dangers to sewage management systems in residential and non-residential buildings:

1. **Back-up** of sewage into buildings due to surcharged sewers. This can be caused by floodwaters infiltrating a system, the failure of a utility-owned sewage pump station, the failure of a check or back-



## New and Substantially Improved Buildings Sewage Management Systems



flow prevention valve, or the failure of an effluent ejector pump. Surge of sewers causing sewer back-up can occur outside the flooded area, especially in combined sanitary and storm sewer lines.

2. **Physical damage** of the system components; i.e., pipes, septic tanks, distribution boxes, and distribution pipes. The most common sources of physical damage are erosion, scour, debris impacting risers, collapse of pipe from loss of material, and infiltration at leaky joints. As a result, the systems usually fail as a result of impact and burrowing forces that break and dislodge the system components.
3. **Contamination** of floodwaters by sewage, which presents a health hazard to those who come in contact with the floodwaters. Contamination can be caused by sewage back-up, physical damage to pipes and tanks, seepage of sewage into floodwaters due to leaky pipe connections, and/or loss of power at sewage pump stations and treatment plants.

Any one of the dangers listed above can contaminate and render residential and non-residential buildings uninhabitable and present serious health risks to those who come in contact with floodwaters, thus making cleanup operations expensive and potentially hazardous.

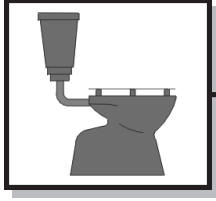
Two approaches must be used simultaneously to eliminate or minimize the dangers that floodwaters present to sewage management systems.

1. Prevent sewer back-up into buildings.
2. Prevent physical damage to the system components.

The major sewage issues that must be addressed when building in a Special Flood Hazard Area (SFHA) are sewage backup and damage to the system caused by the flooding. This chapter will discuss the concepts involved in preventing sewage back up and system damage caused by flooding so that the building can be reoccupied as quickly as possible after the floodwaters have receded.

### NOTE:

A coastal survey of the damage caused by Hurricane Fran to sewage management components showed that most of the damage was caused by erosion and scour, which exposed pipes and tanks and broke many pipe connections.



## New and Substantially Improved Buildings Sewage Management Systems

### 3.4.2 NFIP Requirements

The NFIP requires that the sewage management system in a new or substantially improved structure located in a Special Flood Hazard Area (SFHA) must be designed so that floodwaters cannot damage any component of the system. See *Table 3.4.2* for a summary of compliant mitigation methods.

Methods of Mitigation	A Zones	V Zones
1. Elevation	Highly Recommended	Minimum Requirement
2. Component Protection	Minimum Requirement	Not Allowed*

**Table 3.4.2: Summary of NFIP regulations**

\*Allowed only for those items required to descend below the DFE for service connections.

#### NOTE:

The Design Flood Elevation (DFE) is a regulatory flood elevation adopted by a community that is the BFE, at a minimum, and may include freeboard, as adopted by the community.

1. **Elevation** refers to the location of a component above the Design Flood Elevation (DFE).
2. **Component Protection** refers to the implementation of design techniques that protect a component or group of components located below the DFE from flood damage by preventing floodwater from entering or accumulating within the system components.

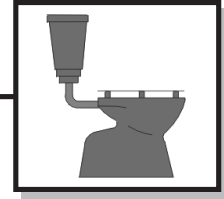
### 3.4.3 Treatment/Disposal Components

In general, the treatment/disposal systems include either an off-site public facility or an on-site facility that is used to temporarily store or treat the sewage. In this section, a description of these facilities and the various components that comprise them will be examined.



A practical strategy for protecting components of sewage treatment and disposal systems from damage by velocity flow and wave action involves designing the components that are to be located below the DFE to ensure stability and sturdiness. In V Zones especially, erosion and scour of sandy soils by velocity flow during a storm are practically impossible to stop. Effort is therefore best applied to designing the system to withstand the forces of velocity flow and debris impact without incurring much, if any, damage. Due to the nature of treatment/disposal components that rely on gravity flow, it is very frequently impossible to elevate the system. In almost all systems, a method of component protection must be developed that can protect the system in-place.

## New and Substantially Improved Buildings Sewage Management Systems



### Public and On-Site Sewage Treatment/Disposal Systems

**Public sewage treatment/disposal systems** convey sewage through collector lines to an off-site public treatment plant. In certain cases the public sewage collector lines also serve as storm water collector lines. This type of system is called a combined sanitary and storm sewer system. Many of the early sewer systems were built, and still operate as, combined systems. See *Figure 3.4.3A* and *Figure 3.4.3B* for examples of off-site sewer systems located in velocity and non-velocity flow areas. As stated previously in Section 3.4.1, only the privately owned on-site portion of public sewage systems is covered in this manual.

**On-site sewage treatment/disposal systems** either treat and dispose of sewage on-site or hold sewage for periodic removal and disposal. The most common on-site sewage treatment and disposal system in residential structures is the septic system. See *Figure 3.4.3C* and *Figure 3.4.3D* for examples of on-site sewer systems located in velocity and non-velocity flow areas. Examples of less commonly used on-site sewage treatment systems include the elevated aeration treatment tank, the elevated solids separation tank, and the cesspool.

Storage facilities typically have one of two different uses. In some cases it is desirable to have a temporary storage tank where all sewage is stored. A contractor must be hired to remove and dispose of the tank contents periodically. The second type of tank is similar, except that it is equipped with a high-pressure ejector pump that detects the level inside the tank and drains the tank into the public sewer system when the internal tank level rises.

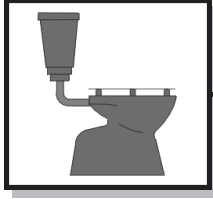
In some cases, older septic tanks can fail or collapse under the overbearing load caused by the weight of saturated soils. These systems may function properly as septic systems prior to flooding, but the structural frame of the tank may have deteriorated so that the added weight of the moisture in the soil causes the tank to collapse.

### Alternate Sewage Systems

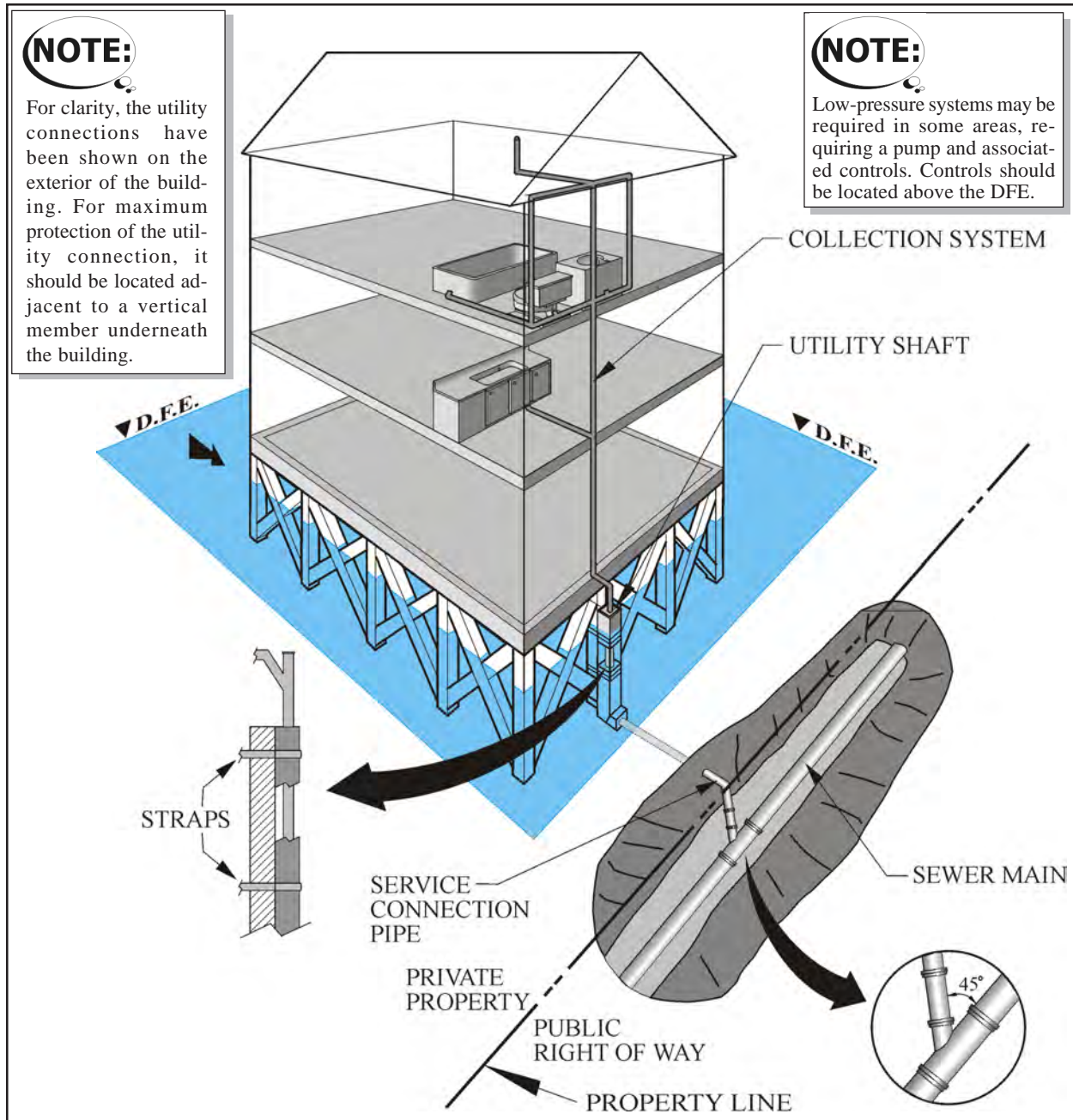
When a backflow prevention valve or gate of a sewage system is closed as a result of surcharged sewers, the sewage collection system within a building cannot be used unless the effluent is either stored temporarily or forced around the valve or gate into the surcharged service connection pipeline through the



In addition to building code and floodplain management, the installation of on-site sewage disposal systems is often regulated through health and sanitary regulations. These regulations are often administered at a different level of government than building codes and standards. In addition, these regulations often exceed the minimum requirements of the NFIP. The reader should reference Chapter 2 of this publication for further information on regulatory issues. Always verify that the sewage management system is one that is permitted by the governing regulatory agencies.



## New and Substantially Improved Buildings Sewage Management Systems



**Figure 3.4.3A: The components of a public sewage management system in a velocity flow area**



## New and Substantially Improved Buildings Sewage Management Systems

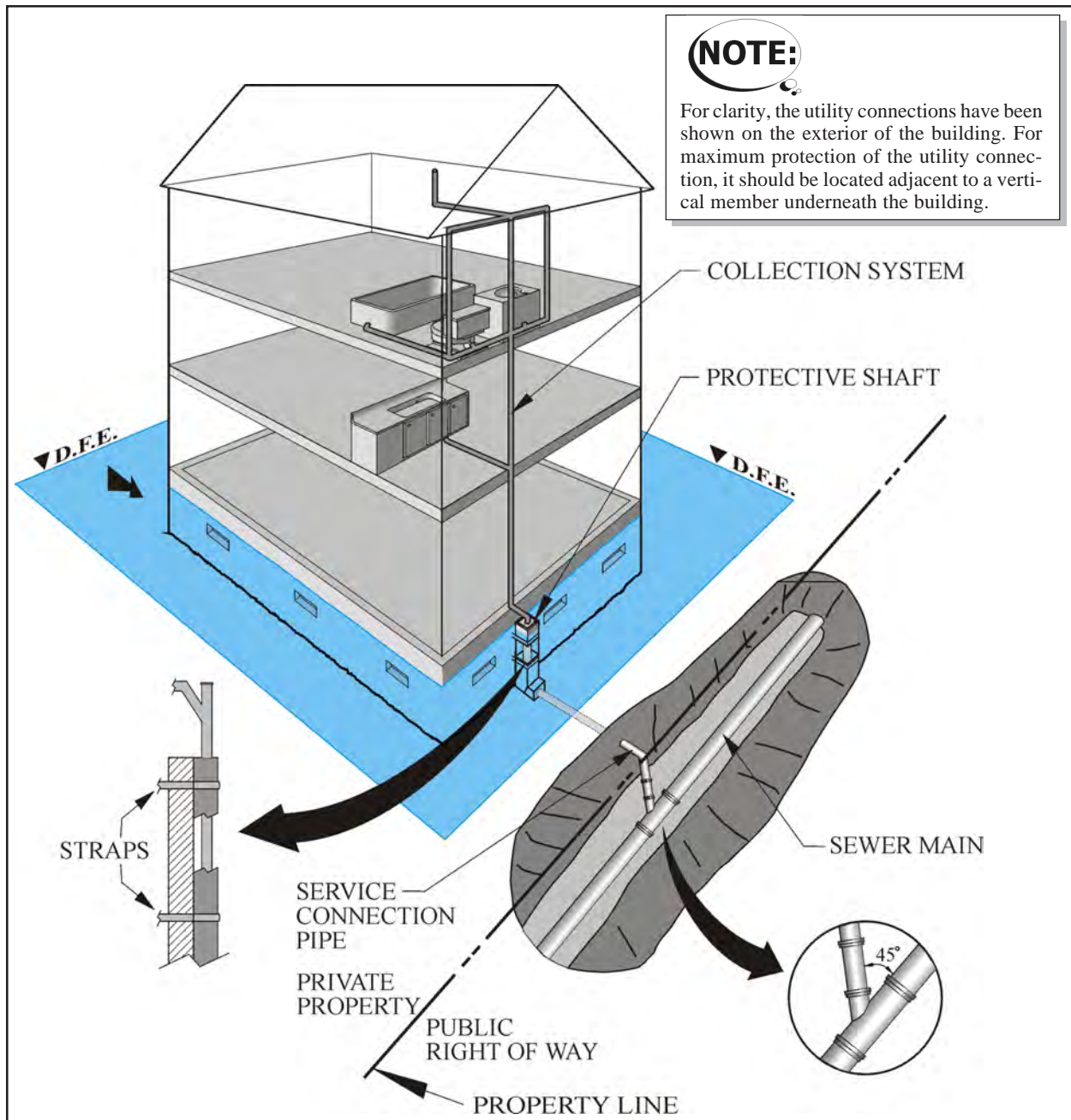
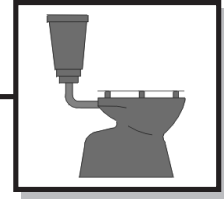
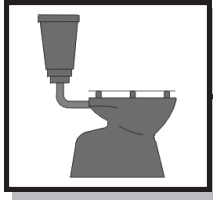
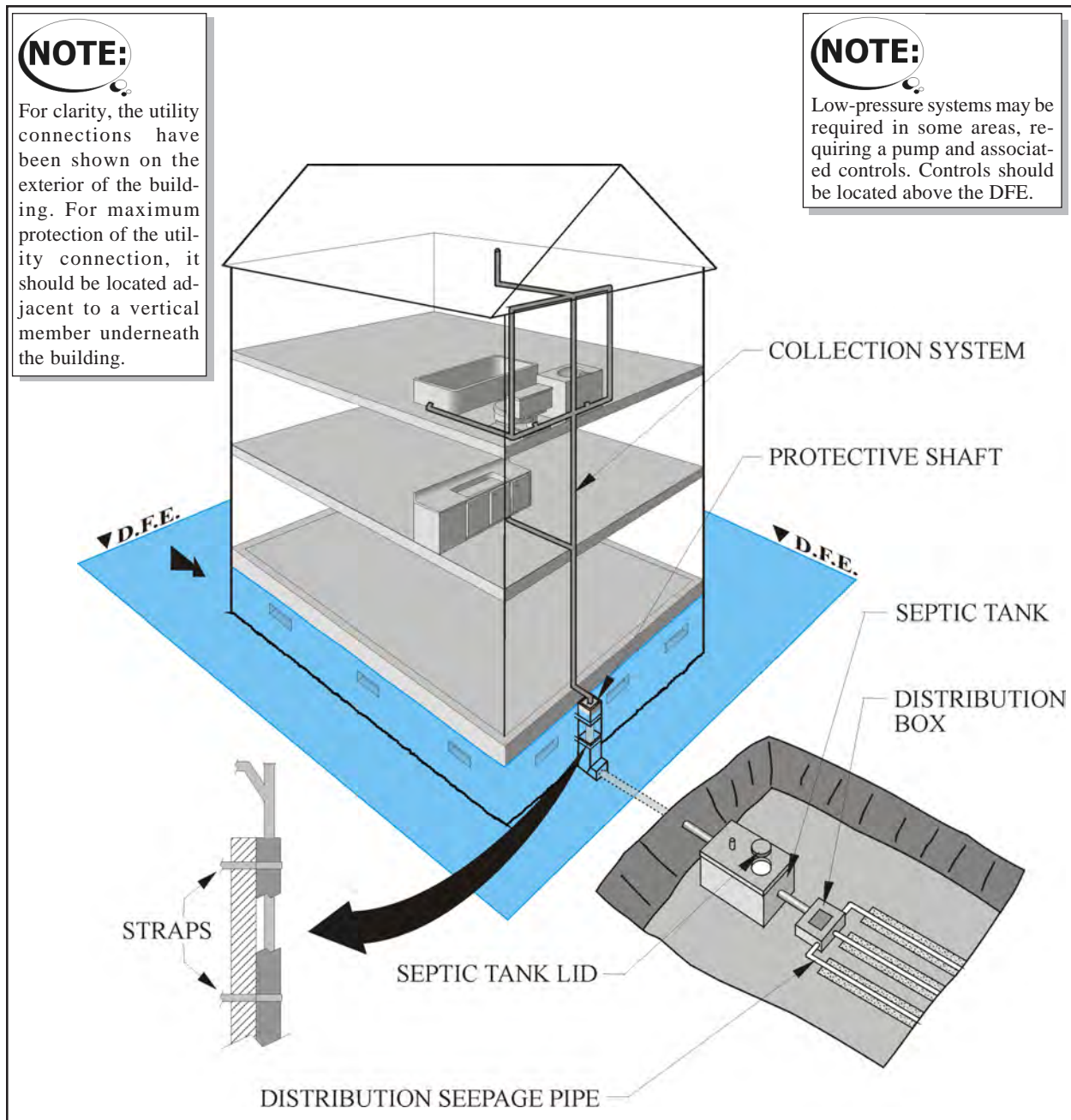


Figure 3.4.3B: The components of a public sewage management system in a non-velocity flow area



## New and Substantially Improved Buildings Sewage Management Systems



**Figure 3.4.3C: The components of a typical on-site sewage management system in a velocity flow area**

## New and Substantially Improved Buildings Sewage Management Systems

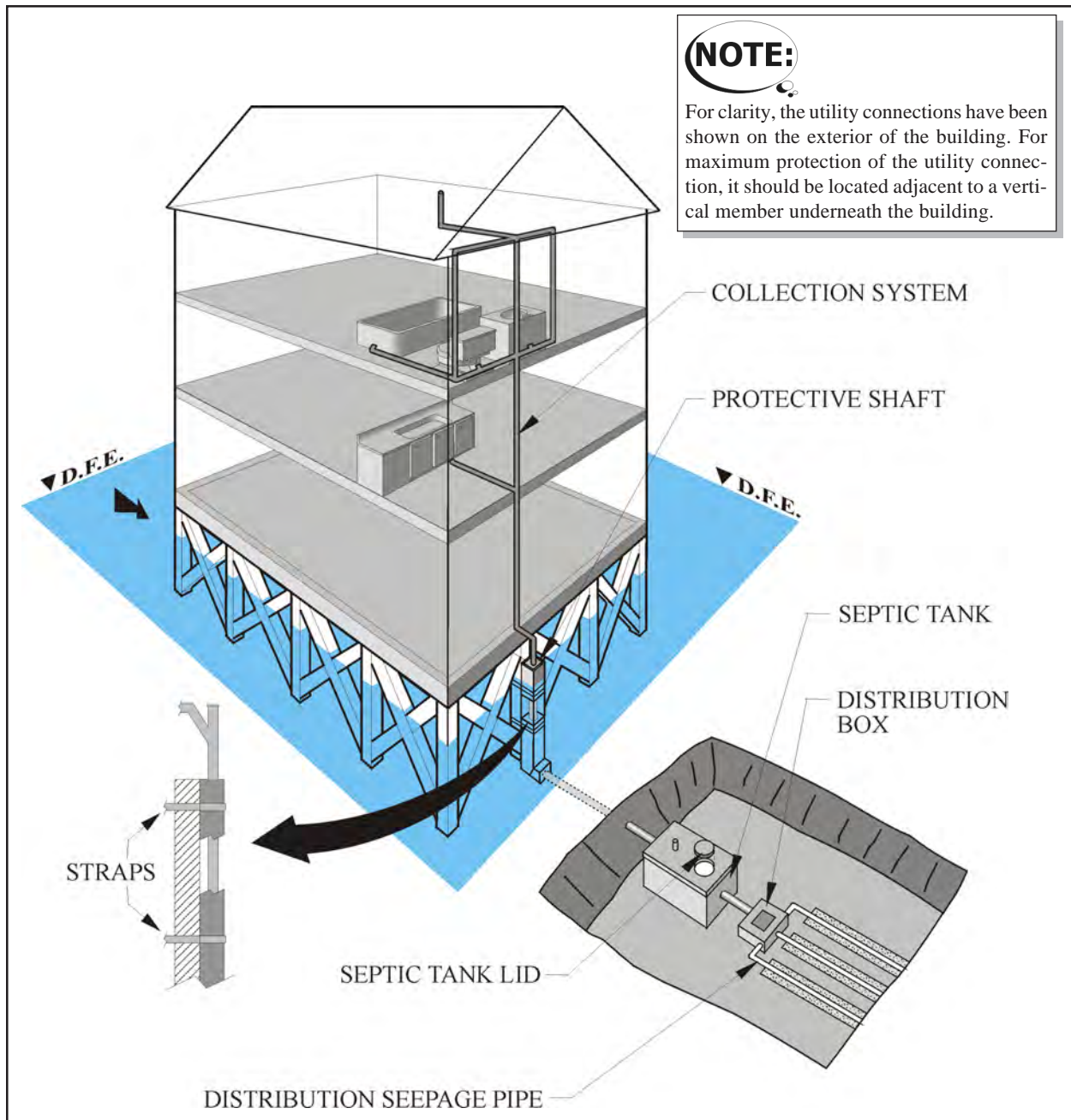
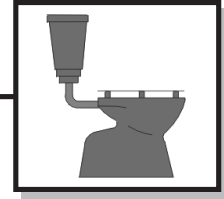
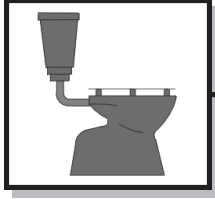


Figure 3.4.3D: The components of a typical on-site sewage management system in a non-velocity flow area





## New and Substantially Improved Buildings Sewage Management Systems



Before a storage tank is designed to temporarily store sewage or a sewage effluent ejector pump is incorporated into a design, local code officials should be consulted to ensure that the local code allows their use.

use of sewage ejection systems. The primary elements of a sewage ejection system are the temporary storage tank, sewage effluent ejector pump, and/or overhead connections.

### A. On-site Sewage Storage Tank

A ready-made plastic or fiberglass tank, a precast concrete tank, or a cast-in-place concrete tank can be used to temporarily store sewage during a flood or surcharged sewer incident. When the floodwaters have receded, the sewage can be pumped out of the tank into the public sewer or on-site treatment system. The tank must be watertight, if installed below the DFE, and installed to resist buoyancy forces as described in Section 3.2.3. Local officials should be consulted to ensure that temporary storage tanks are permitted.

### B. On-site Sewage Effluent Ejector Pump

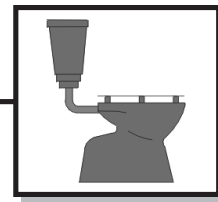
An ejector pump can be used to force sewage through or around an otherwise closed check valve or gate into a surcharged sewer. If a check valve/gate valve combination is installed in the service connection pipe, the gate valve must be open in order for an ejector pump to be used. Before a sewage effluent ejector pump is incorporated into a design that also includes a check valve/gate valve combination in the service connection pipe, the local officials should be consulted to ensure that such a combination is permitted.

Sewage flows from the collection drains into a sump pit or basin. When the level of the effluent is high enough to trigger an automatic switch, the ejector pump sitting at the bottom of the pit is activated. The pump automatically shuts off when the effluent falls below a certain level. The ejector pump could either be used only during a flood or it could be used for normal operation of the sewage collection system. A back-up electrical power source should be provided to ensure operation during an electric power outage that often occurs in association with flooding.

### C. "Overhead" Connections in Non-Residential, Dry Floodproofed Buildings in A Zones

In a new or substantially improved non-residential dry floodproofed building located in an A Zone, it is allowable to have a sewage collection drain below the DFE. With one or more sewage collection drains below the DFE, however, it is necessary to design a system that prevents sewage from backing up into the building when the sewers are surcharged.

## New and Substantially Improved Buildings Sewage Management Systems



As an alternative to using valves and gates, a reliable design technique for preventing sewage back-up into a structure that has one or more sewage collection drains below the DFE is overhead connection of the service connection pipe to the public sewer or on-site treatment system. This is, however, an expensive technique that is used most often in non-residential dry floodproofed structures where it is impractical to elevate all of the sewage collection drains to or above the DFE. This should only be used for that part of the system below the DFE. The requirements for this design technique are:

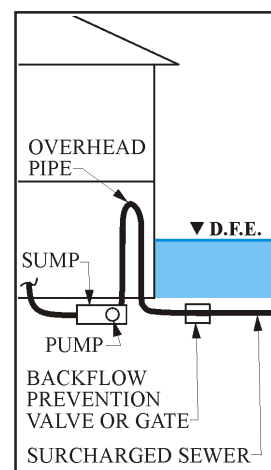
- Sump
- Backflow prevention valve/gate
- Ejector pump
- Pipe that rises from the sump to a point above the DFE before it connects to the sewer or temporary holding tank
- Back-up electric power source

Sewage flows from the collection drains in the structure down to the ejector pump. Then it is pumped up through the overhead pipe to the sewer or on-site treatment system.

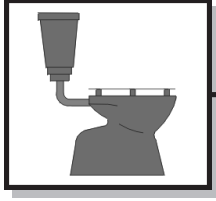
The sewer connection itself does not have to be above the DFE, but the pipe must rise above the DFE before it connects to the public sewer or on-site treatment system to ensure that sewage does not flow back into the structure. To ensure safety, a backflow prevention valve or gate should be installed in the service connection pipeline between the overhead portion of the pipeline and the point of connection to the sewer or on-site treatment systems. In order for the system to operate during a general power outage, a back-up source of power must be used. However, the back-up power is not necessary for flood protection. If the system is not provided with an alternative power source, the sewage for the building cannot be drained in the event of a power failure, therefore, the system should not be used. When power returns, the system should return to normal operation.

### Off site septic systems

In some circumstances, a septic system is not feasible on site and no utility provides sewer service. In extreme cases it may be beneficial for the property owner to locate a piece of property that is nearby and out of the floodplain. The property owner can construct a septic system at that location and



**Figure 3.4.3E: Components of a typical “overhead” sewer**



## New and Substantially Improved Buildings Sewage Management Systems

pump the waste from the original property to the new one for treatment. As with most on-site sewer systems, always check with local officials regarding the use of any sewer system.

In addition to the systems described above, there are many other options for safe effective sewage treatment. If the building is a substantially improved structure, the system that is in place can be of an unknown age and design. Local officials can be of great assistance when analyzing the old system or selecting a new system. They can offer guidance and advice as they are usually aware of the designs that have worked and the ones that have failed.

### Wall Penetrations and Accesses to Septic Tanks and Manholes

This section discusses waterproofing techniques that prevent both the infiltration of floodwaters into a sewage collection and on-site treatment system, and the release of sewage into floodwaters from components of an on-site treatment system. Even where a building does not sustain any significant damage from floodwaters, the presence of contaminated floodwaters can create hazardous conditions for those cleaning flooded buildings, possibly causing delays in rehabilitation and re-occupation of the structure.

To prevent contamination of floodwaters by sewage from pipes and manholes, and the tanks they connect to, these components must be designed to retain their contents even when exposed by erosion and scour, and/or submerged under floodwaters, or surrounded by saturated soil.

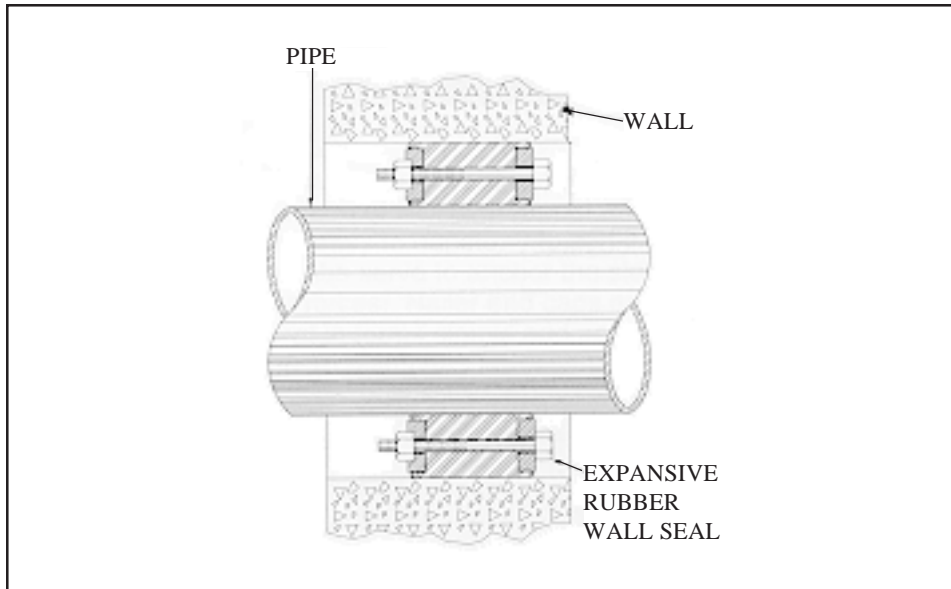
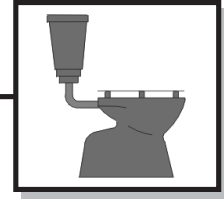
Use of the following techniques can make wall penetrations, manholes, and septic tank access covers watertight, thus preventing contamination of floodwaters:

**Wall Penetrations**—A pipe penetration through an external wall can be sealed using an expansive sealant, a molded sleeve, an elastomeric seal, or a neoprene seal. *Figure 3.4.3F* shows a typical expansive rubber seal.

**Septic Tank or Manhole Access Cover**—As shown in *Figure 3.4.3G*, a neoprene gasket should be applied between the access cover and its seat. In addition, the septic tank access cover should be bolted down. This combination should ensure a watertight seal.

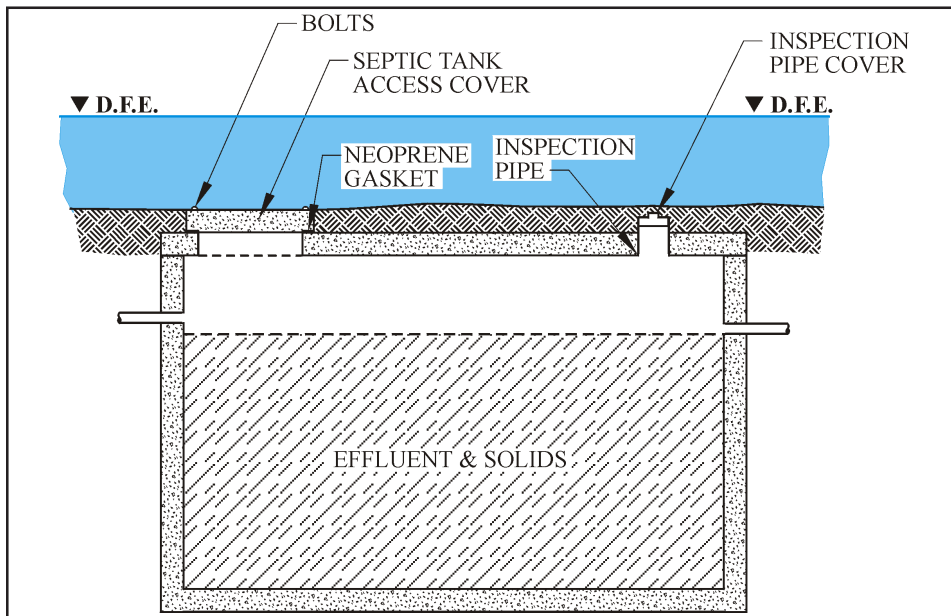
**Inspection Pipe**—The inspection pipe should have a watertight cover such as a screw-on lid, or the pipe should extend above the DFE. In areas that experience floods with velocity flow, such as V Zones and certain A Zones, protec-

## New and Substantially Improved Buildings Sewage Management Systems

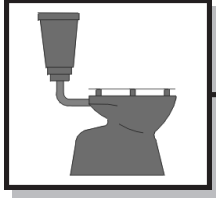


**Figure 3.4.3F: Examples of an expansive rubber wall or floor penetration seal**

Source: PROJEX GROUP Pty. Ltd., Unit 3/39 Rhodes Street, Hillsdale NSW, Australia 2036



**Figure 3.4.3G: Sealed septic tank with lid and access cover**



## New and Substantially Improved Buildings Sewage Management Systems

tion from the forces of velocity flow and debris impact should be provided by enclosing the inspection pipe within a protective cover or manhole.



Some States and communities do not allow septic leach fields in V Zones and certain A Zones.

### **B. Protecting Distribution Pipes in Leach Fields**

On-site sewage disposal is done through leach fields that use the soil as a filter. Solids are removed at the septic tank before partially treated sewage is delivered to the leach field through distribution pipes that lead to seepage trenches, pits, or beds. This is often the final stage of on-site sewage management. These components of the system are typically less likely to be damaged by floodwaters, but they are the most expensive to install. Therefore special care should be exercised when designing the distribution pipes to ensure that they are not exposed to potential damage.

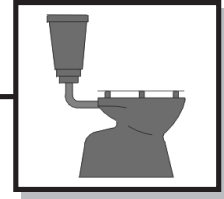
On-site disposal systems are most at risk of flood damage in V Zones and velocity flow A Zones where erosion and scour can expose the components to velocity flow and debris impact. The best protection technique for on-site disposal systems is to locate them outside of floodprone areas. If this cannot be achieved, then on-site disposal systems should be located outside of V Zones and A Zone areas subjected to velocity flow. As a last resort, on-site disposal systems can be protected by burying the distribution pipes and seepage beds, pits, or trenches below the expected level of erosion and scour. If applicable health codes or ordinances do not permit the burial of the disposal system components to a depth protected from erosion and scour or allow them in the floodplain at all; then an acceptable alternative disposal site or method must be chosen.

In addition to the problems caused by erosion and scour, leach fields can be rendered inoperable if the surrounding soil becomes saturated. Leach fields rely on surrounding soil that can accept additional moisture to operate properly. If the surrounding soil cannot accept additional moisture, the leach field will not drain and the septic system will begin to back up. Resolving this type of situation can be very difficult because it is a function of several different factors including soil types, stratification, leach field depth, and water table depth. Therefore, recommendations to remedy this situation are not included in this manual, rather, a qualified sewer designer, who is familiar with local soil conditions, should be consulted.

### **Elevated Treatment Tanks**

An effective strategy for protecting on-site sewage treatment and disposal systems from the effects of velocity flow and wave action is elevation of

## New and Substantially Improved Buildings Sewage Management Systems

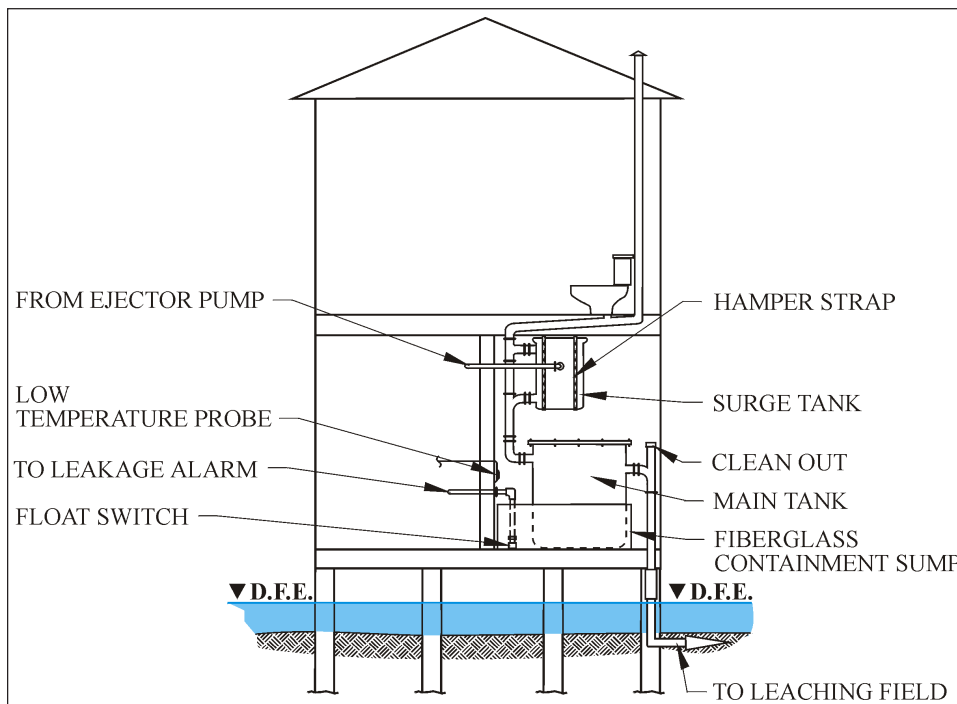


these systems above the DFE. However, the size and weight of the components involved and the need to design most systems for gravity flow from the collection system down to the treatment system make this strategy very expensive, and impractical except in extreme conditions. This strategy has, in fact, only been considered and applied in some V Zone areas where State and/or local regulations do not permit septic tanks to be located below ground.

An elevated treatment tank, as shown in *Figure 3.43H*, is a fiberglass or plastic tank located within the structure above the DFE. From the collection system, sewage is introduced into the tank by gravity flow and/or by ejector pump. The two most common types of elevated tanks are the Aeration Treatment Tank and the Solids Separation Tank.

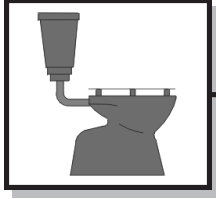


The use of above-ground sewage treatment tanks may not be permitted under State and/or local building codes and health regulations. Consult local officials to determine if this technique is permitted.



**Figure 3.4.3H: An on-site sewage management system using an elevated treatment tank within a V Zone**

Air is pumped into the aeration treatment tank to accelerate the digestion of the solids in the sewage by bacteria that thrive in the presence of oxygen, and the oxidization of some of the elements in the sewage into more manageable compounds.



## New and Substantially Improved Buildings Sewage Management Systems

The solids separation tank functions just like a typical septic tank. The solids are allowed to settle to the bottom of the tank where they are anaerobically digested over time.

In both cases, the sewage in the tank is either conveyed to underground leach fields or pumped out periodically and transported to a public treatment and disposal facility.

### NOTE:

FEMA Publication 257 – *Mitigation of Flood and Erosion Damage to Residential Buildings in Coastal Areas* contains information on the State of Massachusetts' sewage management program enforced in V Zones.

Since the tank is located within the building, the operation of the system must be closely monitored to ensure maximum safety. These design techniques are currently being used in some structures in some coastal communities in Massachusetts where building codes prohibit the location of underground structures such as septic tanks and leach fields in dune areas.

Elevated treatment tanks eliminate the risks presented by velocity flow to sewage treatment systems because none of the components is likely to come in contact with any floodwaters below the DFE. The use of elevated treatment tanks can, however, be an expensive solution.

### 3.4.4 Collection Components

Sewage can back-up into a building in one or a combination of the following situations:

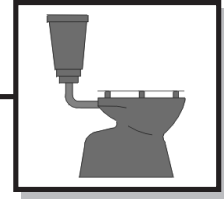
- Where floodwaters infiltrate the sewer system by entering through non-watertight manholes and pipe connections, and breaks in the lines, thus surcharging the sewer.
- Where a building is connected to a publicly owned combined sewer. If the combined sewer located uphill becomes overloaded and surcharged, as in a heavy storm, sewage could back-up into the structure up to the level of the effluent in the sewer.
- Where an off-site sewage pump station, fails due to loss of power. In some cases, a building may not be inundated by floodwaters, but a failed pump station will cause sewage to backup into the building.

These situations are typically caused by failures or ruptures of the collection components.



## New and Substantially Improved Buildings

### Sewage Management Systems



#### Elevation

Sewage back-up into a building located in a flood-prone area can be minimized by elevating all of the collection system components within the structure above the DFE. Elevation can be achieved by locating the components on or above the lowest floor that is above the DFE. However, this method is only effective where the back-up is not caused by the surcharge of sewers located uphill at an elevation higher than the lowest drain into the sewage collection system within the elevated building. Where surcharge of the sewer is due to an uphill overload or a failed pumping station, alternate methods, such as a backflow prevention valve or gate, must be investigated to protect collection system components.



#### Component Protection

##### Valves

Sewage back-up that cannot be prevented by elevation of the collection system components above the DFE is common in communities with combined sewer/stormwater collection systems.

In a situation where the existing building is connected to a gravity-flow combined sewer main downhill from other storm water collection points, sewage back-up is best prevented by installing a valve or gate in the service connection pipe, as shown in *Figure 3.4.4A*. The two types of valves that are often used for this purpose are the Check Valve/Non-Return Valve and the Gate Valve.

A **check valve** allows flow in only one direction. Flow from the opposite direction automatically shuts the valve. Installing a check valve in the sewer service feed pipe ensures that sewage can flow out of the collection system into the public sewer or the on-site treatment system during non-flood conditions but cannot flow back into the building during conditions of flooding.

A **gate valve** must be operated either manually or electrically. When open, a gate valve allows flow in either direction; when closed, a gate valve prevents flow in either direction.



## New and Substantially Improved Buildings Sewage Management Systems

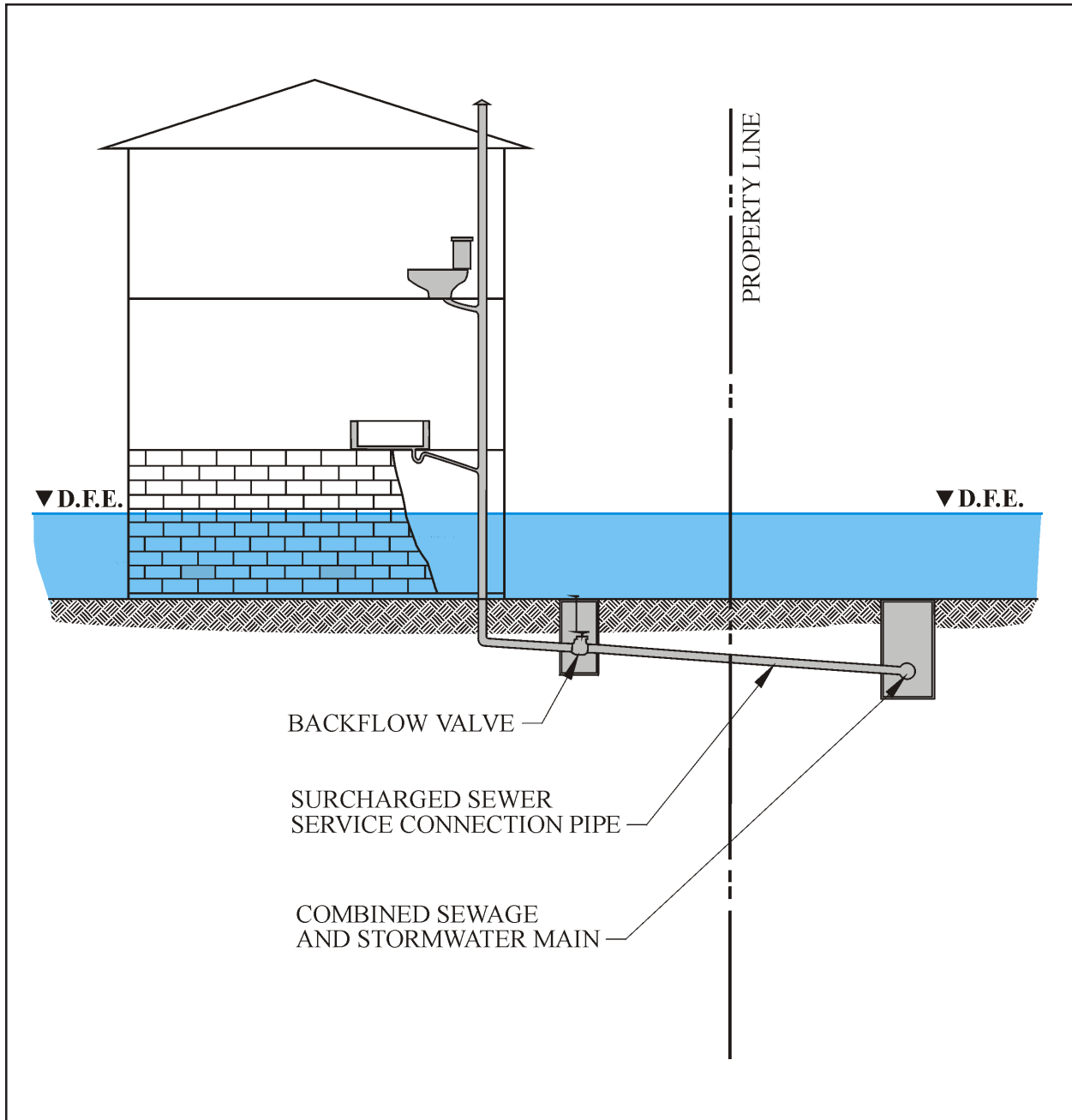
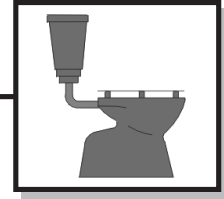
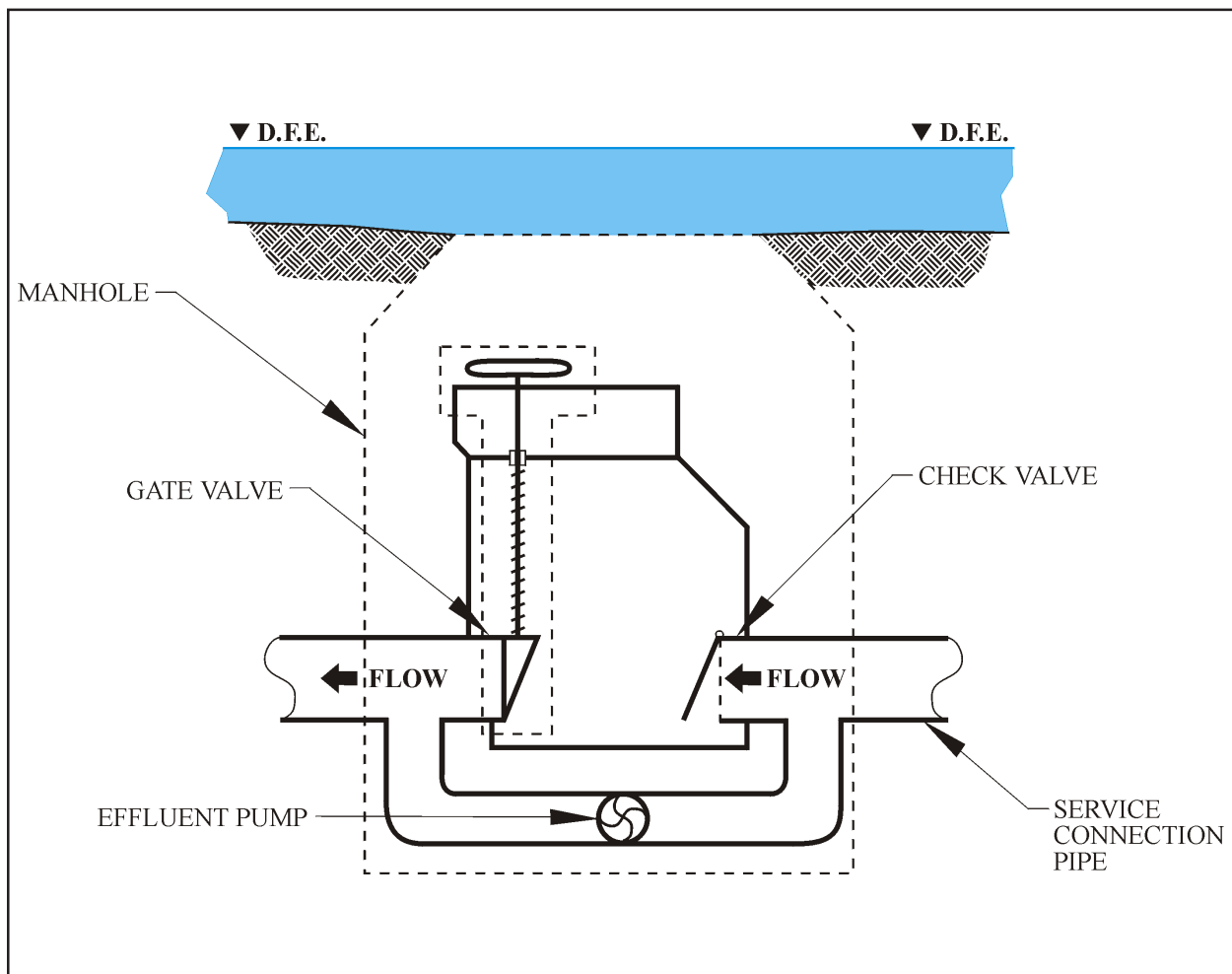


Figure 3.4.4A: Backflow conditions with non-return backflow valve installed

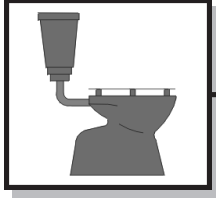
## New and Substantially Improved Buildings Sewage Management Systems



For the best protection against sewage backup, a combination of a check valve and a gate valve should be installed, as shown in *Figure 3.4.4B*. The operation of a check valve can be impaired by the accumulation of debris at the valve opening; while a gate valve is less likely to be affected by debris. With a combination of the two types of valves in use, backed-up sewage would shut the check valve automatically. Then, closing the gate valve either manually or electrically can seal the pipe.



**Figure 3.4.4B: Backflow valve—a check valve and gate valve with an effluent pump bypass**



## New and Substantially Improved Buildings Sewage Management Systems

The local sewer utility typically controls the location of these valves. The building owner is typically responsible for all sewage components from the cleanout at the property line towards the building. The utility normally owns the system portion that extends from the cleanout at the property line all the way back to the sewer treatment plant. The location of the valve will be dictated by whomever is responsible for the installation and maintenance of the valve.

In a building elevated on pilings, the valves should be installed in the vertical service feed pipe between the bottom of the lowest floor and the ground. In a building elevated on a crawl space, the valves can be installed in the service connection pipe either between the bottom of the lowest floor and the ground, or just outside the structure envelope. In a structure on a slab-on-grade, the valves should be installed in the service connection pipe just outside the structure envelope and enclosed in a manhole.

In a floodproofed non-residential structure with a basement in a Zone A, the valves could be installed inside the basement just before the pipe penetrates either the outer wall or the floor. However, typically, these valves are located outside of a building.

### **Sewer Service Connection Pipe**

The sewer service connection pipe is the part of the sewage collection system into which all of the sewage collection pipes within a building deliver effluent. The sewer service connection pipe delivers the effluent to either the public sewer or to the on-site treatment system. In an elevated building, this pipe is often the most vulnerable part of the sewage collection system because it is exposed from the bottom of the lowest floor to the ground. In a V Zone or a high-velocity A Zone, this length of pipe is at risk of being damaged, dislodged, or broken by velocity flow, wave action, and debris impact. The service connection pipe can be protected using one of the following three methods:

1. The sewage collection pipe can be protected from flood damage by attaching it onto the landward or downstream side of a vertical supporting structure (wall, pillar, pile, or column) using straps, as shown in *Figure 3.4.4C*. The vertical supporting structure provides support and protection from the direct impact of debris, wave action, and velocity flow. In coastal zones where salt water and salty air can accelerate corrosion, the straps attaching the pipe onto the vertical supporting structure should be of non-corrosive material.

## New and Substantially Improved Buildings Sewage Management Systems

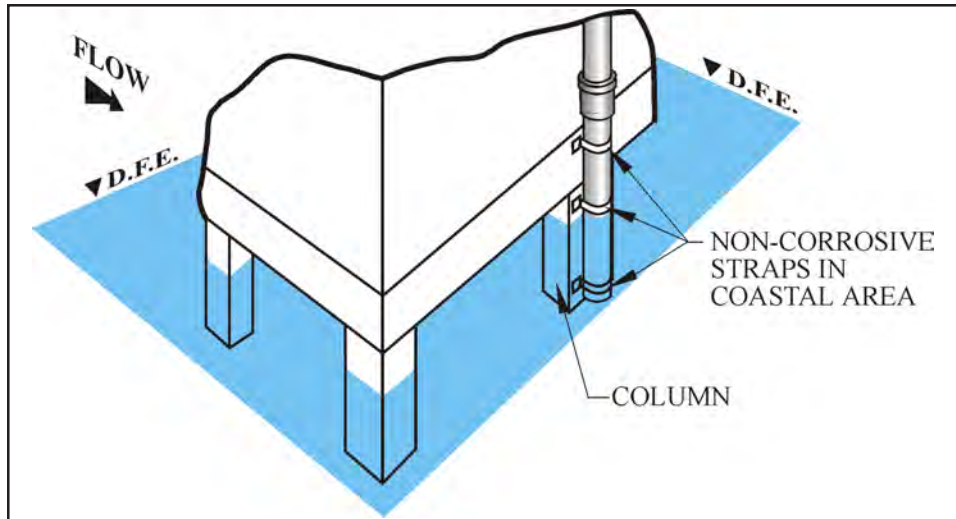
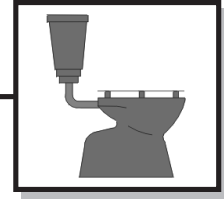


Figure 3.4.4C: A service connection pipe strapped to a pile

2. Another flood-resistant design technique involves enclosing the service connection pipe inside a concrete or masonry utility shaft extending from ground level to a point above the DFE, or to the bottom of the lowest floor, as shown in *Figure 3.4.4D*. This protects the pipe

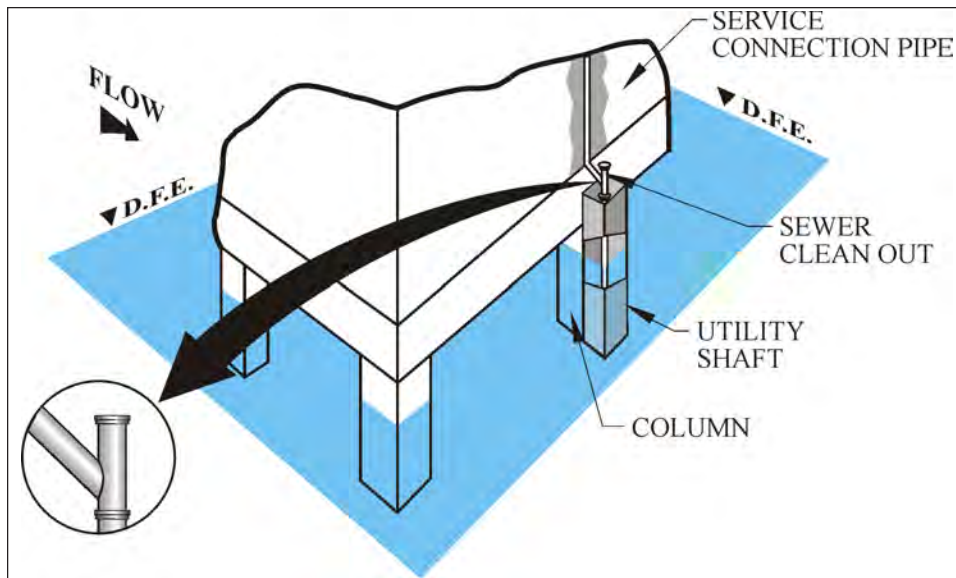


Figure 3.4.4D: A service connection pipe enclosed in a utility shaft

### NOTE:

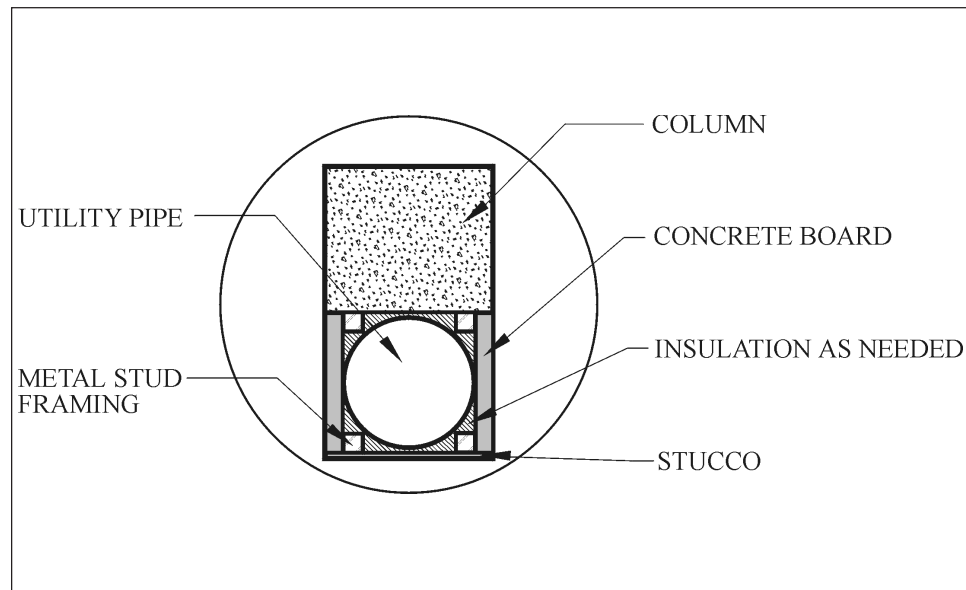
For clarity, the utility connections have been shown on the exterior of the building. For maximum protection of the utility connection, it should be located adjacent to a vertical member underneath the building.



## New and Substantially Improved Buildings Sewage Management Systems

from debris impact, velocity flow, and wave action. Such a utility shaft could also contain other utility service connection lines, and it should have holes at the bottom to allow water to drain out.

3. The service connection pipe can also be enclosed within a shaft built around the pipe using metal stud framing with cement board and stucco, as shown in *Figure 3.4.4E*. The pipe and shaft must be attached to the landward or downstream side of a column or non-break-away wall.

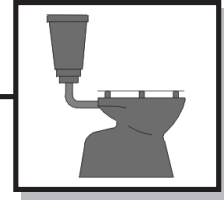


**Figure 3.4.4E: Top view of utility shaft made of metal framing with cement board and stucco**

### 3.4.5 Conclusion

When the sewage management system of a building is properly protected from flood damage, the structure can be brought back into operating order more quickly. *Figures 3.4.5A* and *3.4.5B* are flow charts designed to assist with the design of flood-resistant sewage management systems in new and substantially improved buildings. *Tables 3.4.5A* and *3.4.5B* are checklists

## **New and Substantially Improved Buildings Sewage Management Systems**



intended to aid in the assessment of the sewage management system of an existing or proposed building. In addition, a sketch sheet is included that can be used to make additional notes about the system. With a proper assessment of a building and some careful planning before a flooding event occurs, the damage to the on-site components of the sewage management system can be minimized.





## New and Substantially Improved Buildings Sewage Management Systems

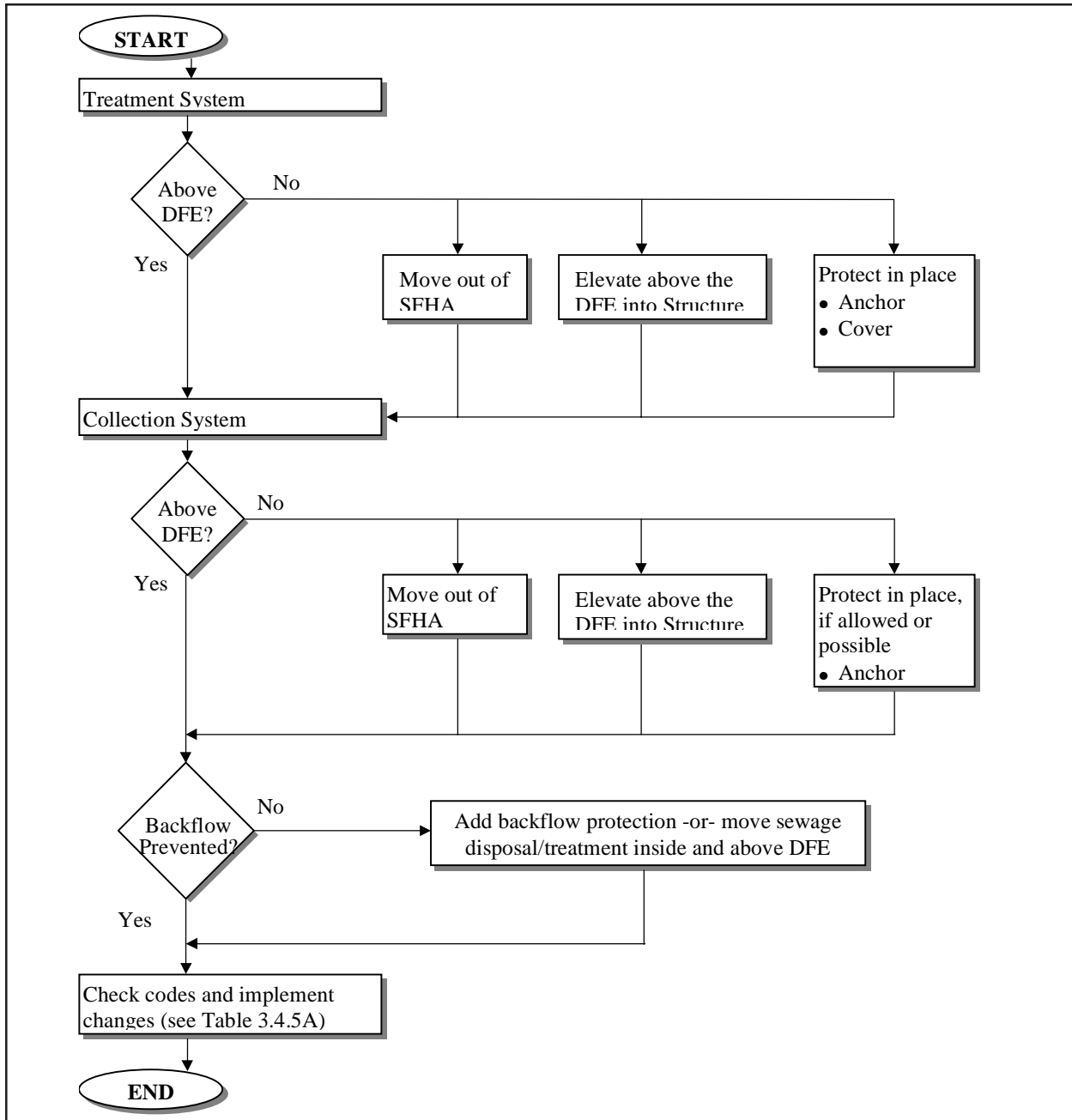


Figure 3.4.5A: Flow chart of on-site flood resistant sewage management system design

## New and Substantially Improved Buildings Sewage Management Systems

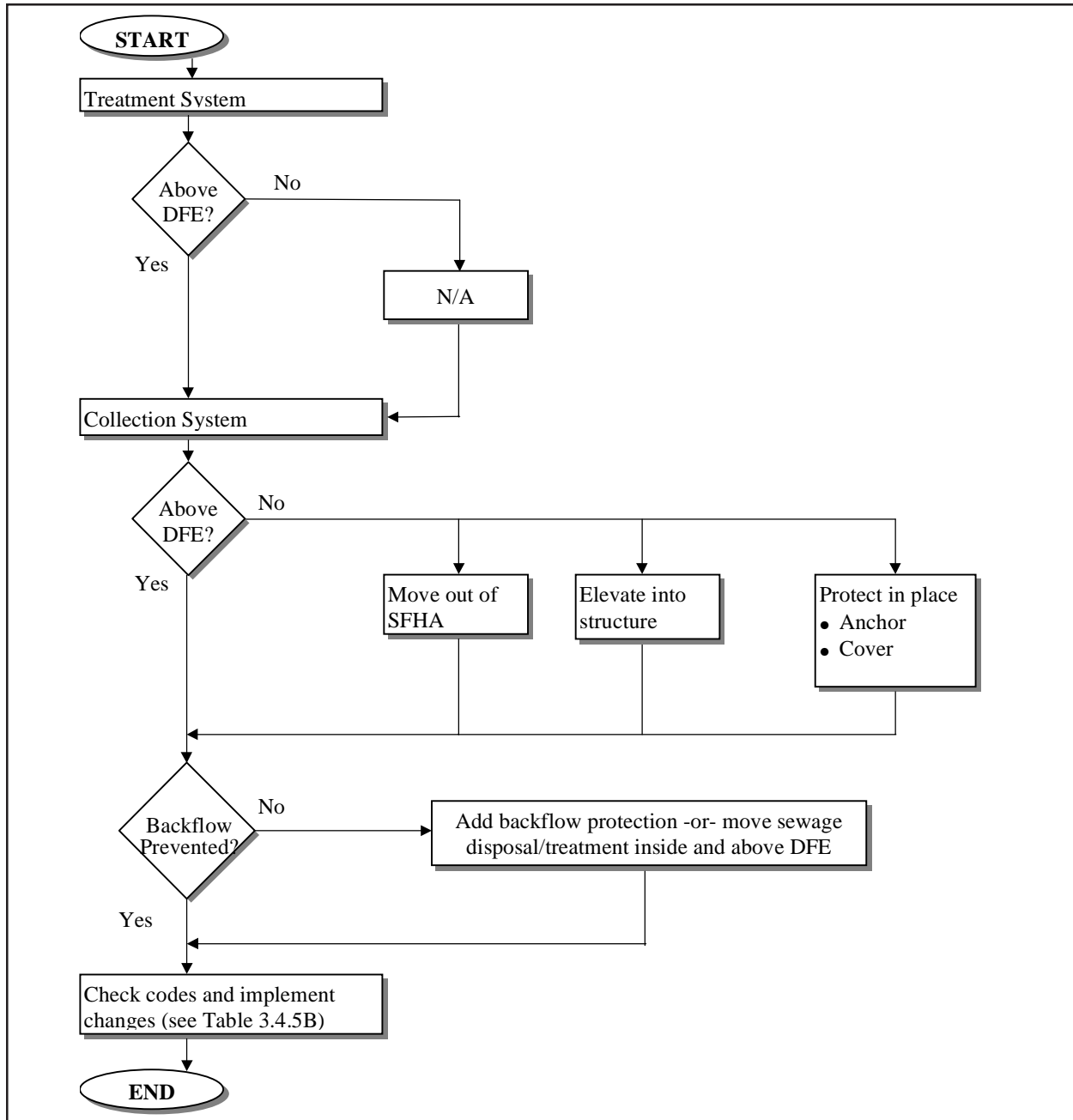
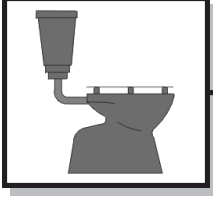


Figure 3.4.5B: Flow chart of off-site flood resistant sewage management system design



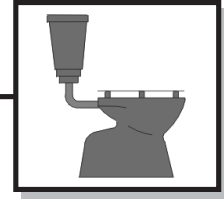
## New and Substantially Improved Buildings Sewage Management Systems

### FLOOD RESISTANT ON-SITE SEWAGE MANAGEMENT SYSTEM CHECKLIST

Property ID:		Property Contact:			
Property Name:		Interviewed:			
Property Address:		Phone:			
Surveyed By:		Date Surveyed:			
DFE:					
Is the leach field located in the SFHA? <input type="checkbox"/> Yes <input type="checkbox"/> No					
Is it protected from erosion and scour? <input type="checkbox"/> Yes <input type="checkbox"/> No; Description:					
Is the distribution box located in the SFHA? <input type="checkbox"/> Yes <input type="checkbox"/> No					
Is it protected from erosion and scour? <input type="checkbox"/> Yes <input type="checkbox"/> No; Description:					
Is the septic tank located in the SFHA? <input type="checkbox"/> Yes <input type="checkbox"/> No					
Is it protected from erosion and scour? <input type="checkbox"/> Yes <input type="checkbox"/> No; Description:					
Is it protected from impact? <input type="checkbox"/> Yes <input type="checkbox"/> No; Description:					
Is the building's sewer connection pipe protected from impact? <input type="checkbox"/> Yes <input type="checkbox"/> No					
Description:					
Is the system equipped with a storage tank, ejector pump or backflow prevention valve?					
Description:					
Who is responsible for it?					
Is the system composed of another on-site treatment system? <input type="checkbox"/> Yes <input type="checkbox"/> No					
Description:					
Are all of the drains within the structure located above the DFE? <input type="checkbox"/> Yes <input type="checkbox"/> No					
Description:					
• What equipment is located beneath the DFE?					
<input type="checkbox"/> Septic Tank	<input type="checkbox"/> Distribution Box	<input type="checkbox"/> Connection Pipe	<input type="checkbox"/> Ejector Pump	<input type="checkbox"/> Storage Tank	<input type="checkbox"/> Backflow Valve
<input type="checkbox"/> Drain:	<input type="checkbox"/> Other:				

**Table 3.4.5A: Checklist for on-site flood resistant sewage management system design**

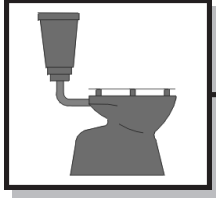
## New and Substantially Improved Buildings Sewage Management Systems



### FLOOD RESISTANT OFF-SITE SEWAGE MANAGEMENT SYSTEM CHECKLIST

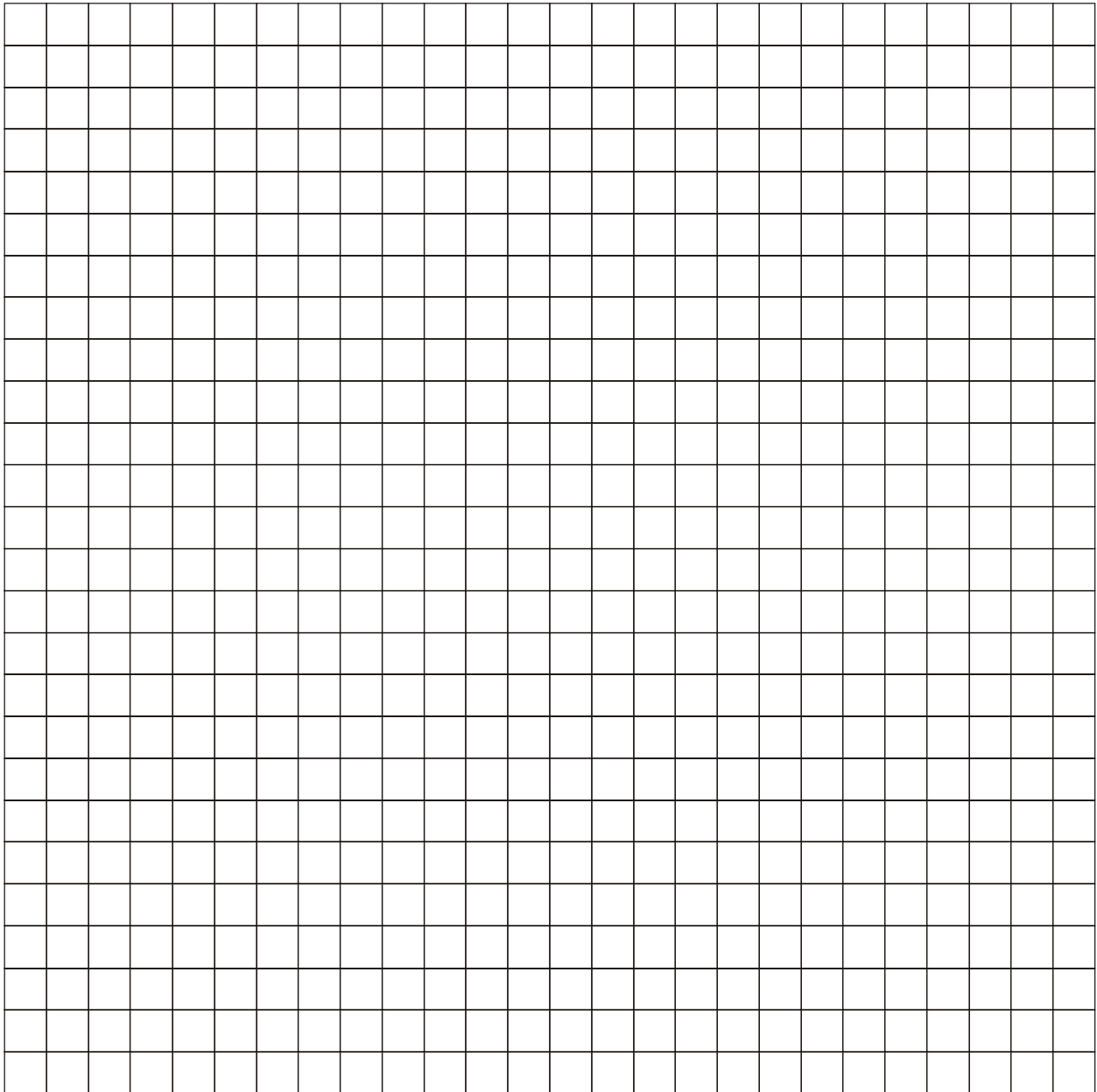
Property ID:		Property Contact:			
Property Name:		Interviewed:			
Property Address:		Phone:			
Surveyed By:		Date Surveyed:			
DFE:					
Is the building's sewer connection pipe protected from impact? <input type="checkbox"/> Yes <input type="checkbox"/> No					
Is it protected from erosion and scour? <input type="checkbox"/> Yes <input type="checkbox"/> No					
Description:					
Is the system equipped with a storage tank, ejector pump or backflow prevention valve?					
Description:					
Who is responsible for it?					
Are all of the drains within the structure located above the DFE? <input type="checkbox"/> Yes <input type="checkbox"/> No					
Description:					
• What equipment is located beneath the DFE?					
<input type="checkbox"/> Connection Pipe	<input type="checkbox"/> Storage Tank	<input type="checkbox"/> Ejector Pump	<input type="checkbox"/> Backflow Valve	<input type="checkbox"/> Drain:	<input type="checkbox"/> Drain:
<input type="checkbox"/> Other:	<input type="checkbox"/> Other:				

Table 3.4.5B: Checklist for off-site flood resistant sewage management system design



## New and Substantially Improved Buildings Sewage Management Systems

**Sketch sheet  
(for details, notes, or data regarding system installations)**



**CONTENTS**

	<b>Page</b>
<b>3.5 Potable Water Systems</b>	<b>3.5-2</b>
<b>3.5.1 Introduction</b>	<b>3.5-2</b>
<b>3.5.2 NFIP Requirements</b>	<b>3.5-6</b>
<b>3.5.3 Supply Systems</b>	<b>3.5-7</b>
<b>3.5.4 Distribution Components</b>	<b>3.5-7</b>
<b>3.5.5 Conclusion</b>	<b>3.5-9</b>

**FIGURES**

<b>Figure 3.5.1A: Components of a public potable water supply system in a non-velocity flow area</b>	<b>3.5-3</b>
<b>Figure 3.5.1B: Components of a public potable water supply system in a velocity flow area</b>	<b>3.5-4</b>
<b>Figure 3.5.1C: The components of an on-site potable water system</b>	<b>3.5-5</b>
<b>Figure 3.5.5: Flow chart of flood resistant sewage management system design</b>	<b>3.5-10</b>

**TABLES**

<b>Table 3.5.2: Summary of NFIP regulations</b>	<b>3.5-6</b>
<b>Table 3.5.5: Checklist for flood resistant sewage management system design</b>	<b>3.5-11</b>



## **3.5 Potable Water Systems**

### **3.5.1 Introduction**

The water supply system in a structure located in a flood-prone area must be designed so that floodwaters do not contaminate the potable water systems and create a health hazard.

A building's potable water system can be arranged into two components:

1. Water Supply Systems
2. Distribution Components

**Water Supply Systems** generally include a source of potable water and transport of the water to the property or the surface of the ground. Water supply systems are typically one of two types:

1. Public utility system, which is fed from a public utility water supply main. *Figures 3.5.1A and 3.5.1B* show typical public utility water supply systems in non-velocity and velocity flow areas, respectively.
2. On-site system, which is fed from an on-site well. *Figure 3.5.1C* show a typical on-site well water system in a non-velocity flow area.

**Distribution Components** generally include a usage meter, a service feed pipe, water heater and a distribution system.

#### **NOTE:**

This manual excludes discussion of public water mains, public service lines, and public water supply plants which lie beyond the usage meter.

In a public water system, the public utility provides water supply through a water main and service line to the edge of the public right-of-way, where the water usage meter is located. The service feed pipe from the structure then connects to the usage meter. For structures connected to public water supply, only the service feed pipe and the on-site distribution system are covered in this manual.

In an on-site water supply system, the source of water is a private on-site well, and the owner is responsible for the operation and maintenance of the well. The water service feed pipe is the main pipeline that connects the on-site water well to the distribution system within a structure. The distribution



## New and Substantially Improved Buildings Potable Water Systems

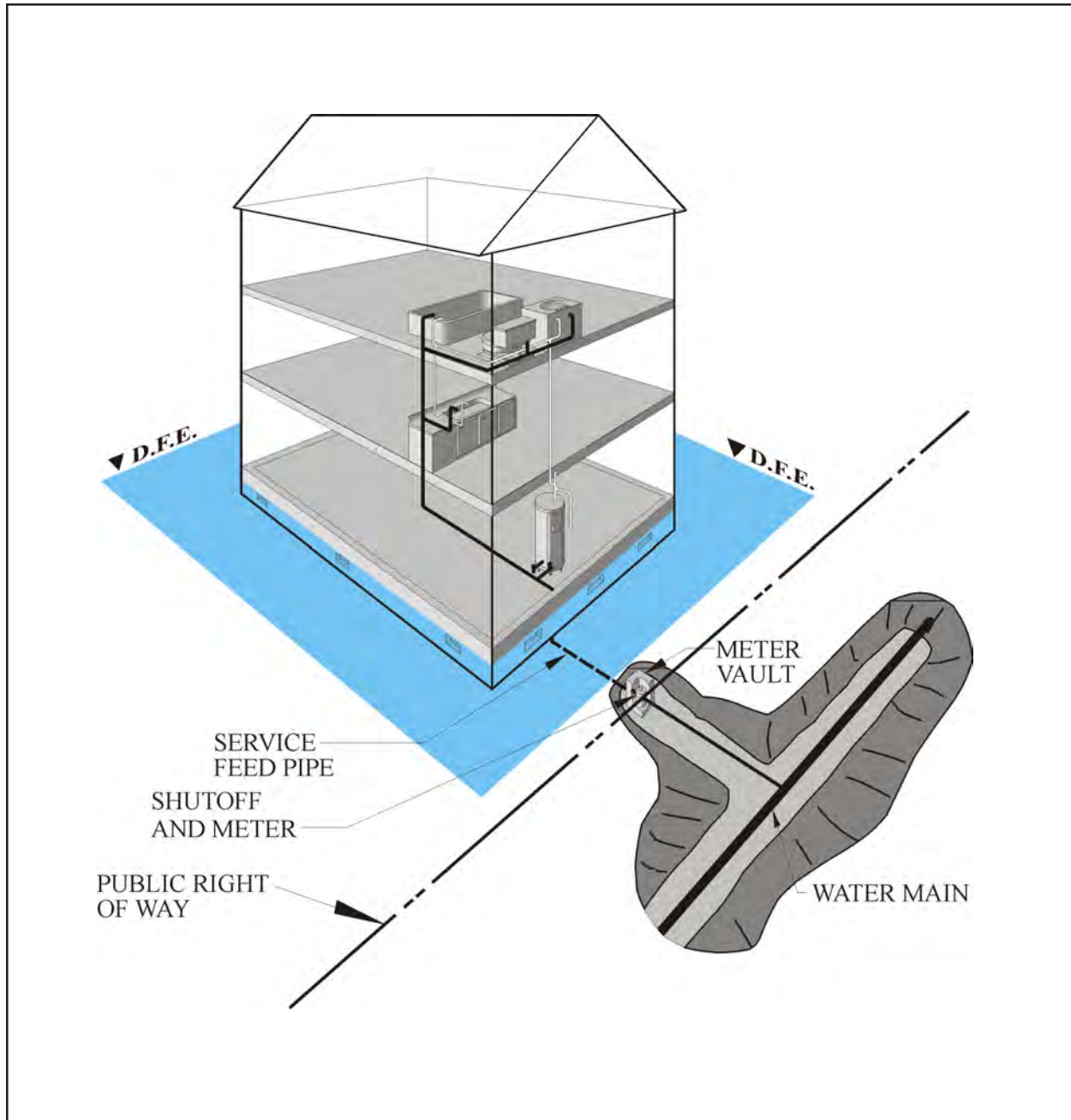
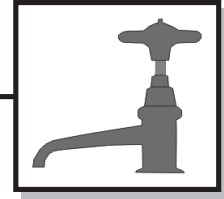


Figure 3.5.1A: Components of a public potable water supply system in a non-velocity flow area



## New and Substantially Improved Buildings Potable Water Systems

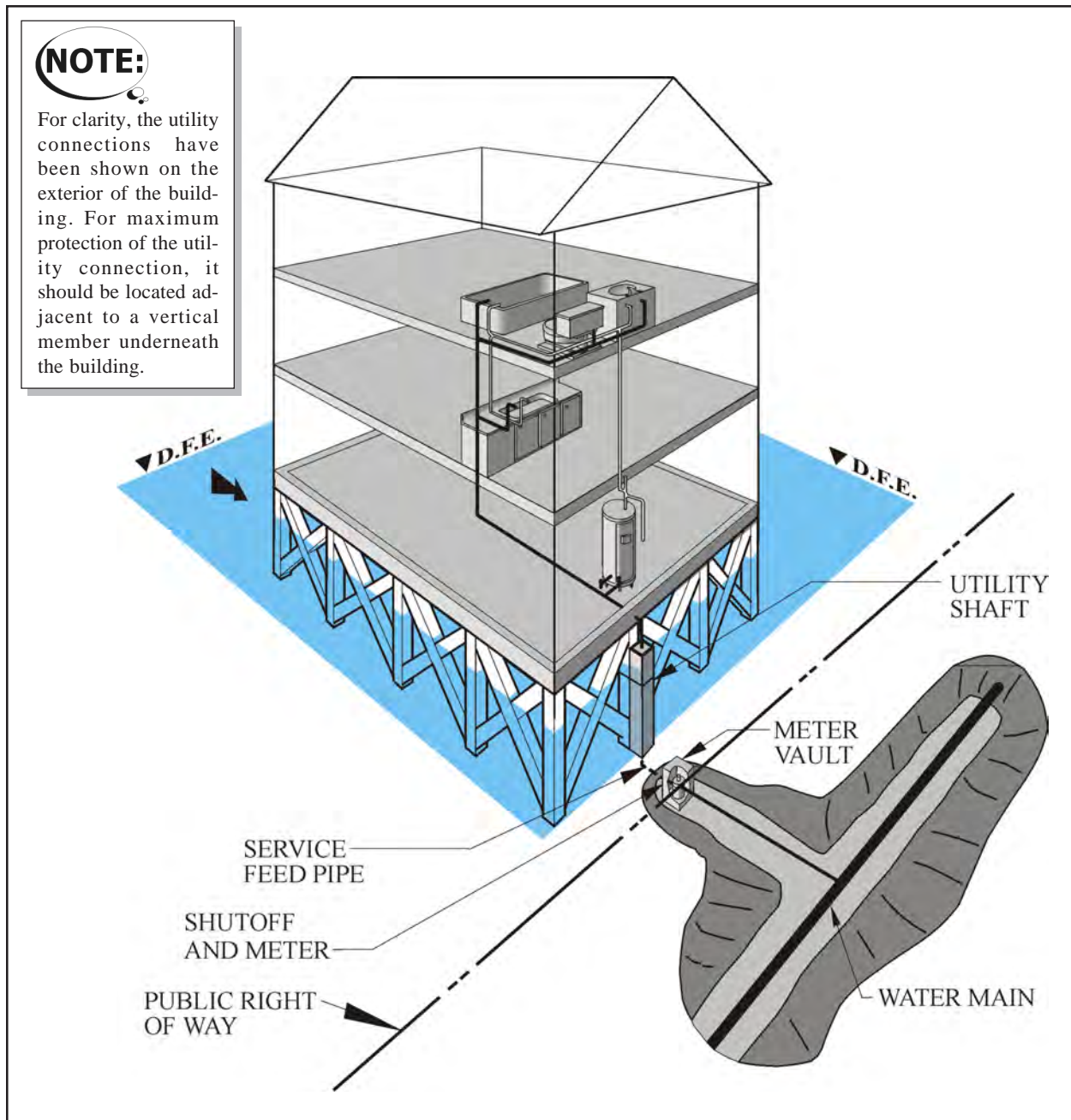


Figure 3.5.1B: Components of a public potable water supply system in a velocity flow area

# New and Substantially Improved Buildings

## Potable Water Systems

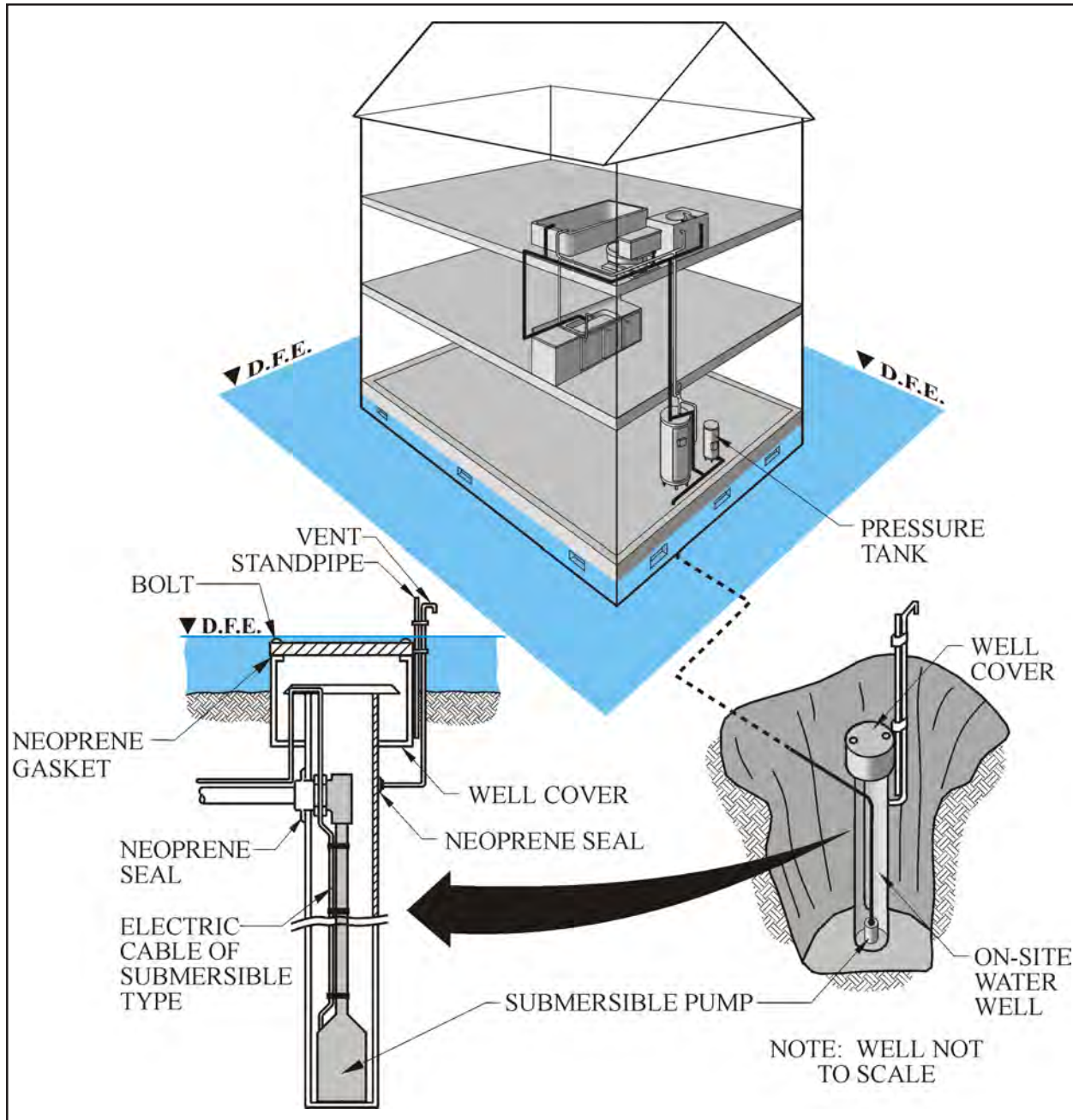
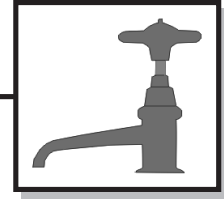


Figure 3.5.1C: The components of an on-site potable water system



## New and Substantially Improved Buildings Potable Water Systems

### NOTE:

This chapter applies to new and substantially improved structures that must be built in compliance with the minimum requirements of the NFIP. Many of the structures that were built prior to the adoption of floodplain management regulations by communities have building utilities systems that are not resistant to flood damages. For additional information on how to protect building utility systems in these structures, see Chapter 4 on Existing Buildings.

system includes the pressure tank and all the pipes and water delivery accessories (faucets, showers, etc.) in a structure.

The two main dangers that floodwaters present to water supply systems are:

1. Damage to pipes and to the on-site well head from the effects of velocity flow, wave action, and debris impact.
2. Water supply contamination in the well, service feed pipe, and distribution system.

In general, the figures in this chapter attempt to illustrate some general practices that meet the requirements of the National Flood Insurance Program (NFIP). Local codes and health/sanitary regulations permit many variations that also meet NFIP regulations. Please refer to your local code officials for specific practices that may meet both the NFIP regulations and local code.

### 3.5.2 NFIP Requirements

The NFIP requires that the water supply system in a new or substantially improved structure located in a Special Flood Hazard Area (SFHA) be designed so that floodwaters do not enter or accumulate within system components and to additionally ensure that floodwater does not contaminate the potable water supply system. See *Table 3.5.2* for a summary of compliant mitigation methods.

Methods of Mitigation	A Zones	V Zones
1. Elevation	Highly Recommended	Minimum Requirement
2. Component Protection	Minimum Requirement	Not Allowed*

**Table 3.5.2: Summary of NFIP regulations**

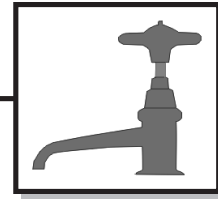
\*Allowed only for those items required to descend below the DFE for service connections.

1. **Elevation** refers to the location of a component above the Design Flood Elevation (DFE).
2. **Component Protection** refers to the implementation of design techniques that protect a component or group of components located below the DFE from flood damage by preventing floodwater from entering or accumulating within the system components.

### NOTE:

The Design Flood Elevation (DFE) is a regulatory flood elevation adopted by a community that is the BFE, at a minimum, and may include freeboard, as adopted by the community.





### 3.5.3 Supply Systems

The main threat that floodwaters pose to water supply systems is contamination. By definition and industry standards, water supply systems are designed to be watertight. Water supply systems are often contaminated by floodwaters through infiltration into the on-site water well or public supply.

Velocity flow, wave action, and floating debris, which are characteristic of floods in areas with high velocity flows, can cause considerable damage to exposed on-site well heads located below the DFE. This can result in contamination of the water system. Erosion and scour can expose public water mains and service connections, leaving them vulnerable to being contaminated.

#### Protecting On-Site Water Wells

Water wells in flood-prone areas that experience velocity flow must be designed to withstand the effects of velocity flow, wave action, and debris impact. Velocity flow can erode and scour the soil away from the well head and expose it to the direct impact of debris and moving water. Damage to the well head would allow floodwaters to infiltrate and contaminate the well.

It is strongly recommended that all water wells located in flood-prone areas be equipped with a watertight casing that extends from one foot above grade to 25 feet below grade. In flood-prone areas that experience velocity flow, the watertight casing can be protected from damage by one of the following methods:

1. The casing could be ductile iron pipe which is strong enough to resist debris impact.
2. A commercially available protective well cover could be installed. These covers range from metal boxes or cylinders to concrete manholes.

#### **NOTE:**

For more information, see FEMA Publication 102—*Floodproofing Non-Residential Structures*, page 100.

### 3.5.4 Distribution Components

The main threat that floodwaters pose to water supply distribution system components is contamination. By definition and industry standards, water supply systems are designed to be watertight. Water supply systems are often contaminated by floodwaters through infiltration into open faucets and/or broken pipes.



## New and Substantially Improved Buildings Potable Water Systems

Velocity flow, wave action, and floating debris, which are characteristic of floods in areas with high velocity flows, can cause considerable damage to exposed service connection pipes and outdoor faucets located below the DFE. This can result in contamination of the water system.

### Elevation



Outdoor faucets, showerheads, and utility sinks can best be protected by elevation above the DFE. To allow proper accessibility of faucets, they could be located so that they can be reached from a deck, porch, or staircase. In addition, a backflow prevention valve can be installed on the water connection to prevent contamination of the water supply.

In A Zones, the water heater and pressure tank must be elevated or protected in place. In V Zones, all potable water system components must be elevated except for service connections. The water heater is particularly susceptible to damage by flood inundation. Floodwaters could damage the heating element and render the unit inoperable when the floodwaters recede.

The location of the water meters is usually dictated by the water utility. Typically, they will not permit the meter to be raised above the DFE because of possible freeze damage. Therefore, these units must typically be protected in place.

### Component Protection

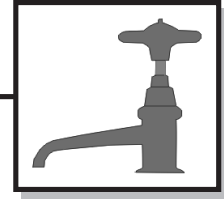
Water meters are typically located below grade to protect them from frost damage or freezing. However, some precautions can be taken to minimize damage to the water meter. If possible, locate the meter on a portion of the property that is above the DFE. If it must be located below the DFE, it should be protected using, for example, riprap. If erosion, due to velocity flow, is a concern, the local water utility can choose to locate the meter above the DFE if proper access is provided and it can be protected from freezing.

If, in A Zones, a hot water heater or pressure tank is not located above the DFE, a waterproof wall must be constructed around them to at least the DFE as shown in *Figure 3.1.4.D*. In addition, they should be firmly secured to the floor or adjacent wall.

When distribution pipes must be located below the DFE, they should be protected from debris impact, velocity flow, wave action, as well as erosion

## New and Substantially Improved Buildings

### Potable Water Systems



and scour. Pipes that are located below grade should be properly embedded to minimize potential exposure to debris impact when the overburden scours away. Distribution piping located below the DFE should be located on the landward or downstream side of the flood and be protected in a debris impact resistant chase adjacent to a permanent building member.

### 3.5.5 Conclusion

When the water supply system of a building is properly protected from flood damage, the structure can be brought back into operating order more quickly. *Figure 3.5.5* is a flow chart designed to assist you with the design of flood-resistant water supply systems in new and substantially improved buildings. *Table 3.5.5* is a checklist to aid in the review of proposed designs or existing systems for compliance with Federal, State, and local regulations. In addition, a sketch sheet is included that can be used to make notes about the potable water system. With a proper assessment of a building and some careful planning before a flooding event occurs, the damage to the building's water supply system can be minimized.





## New and Substantially Improved Buildings Potable Water Systems

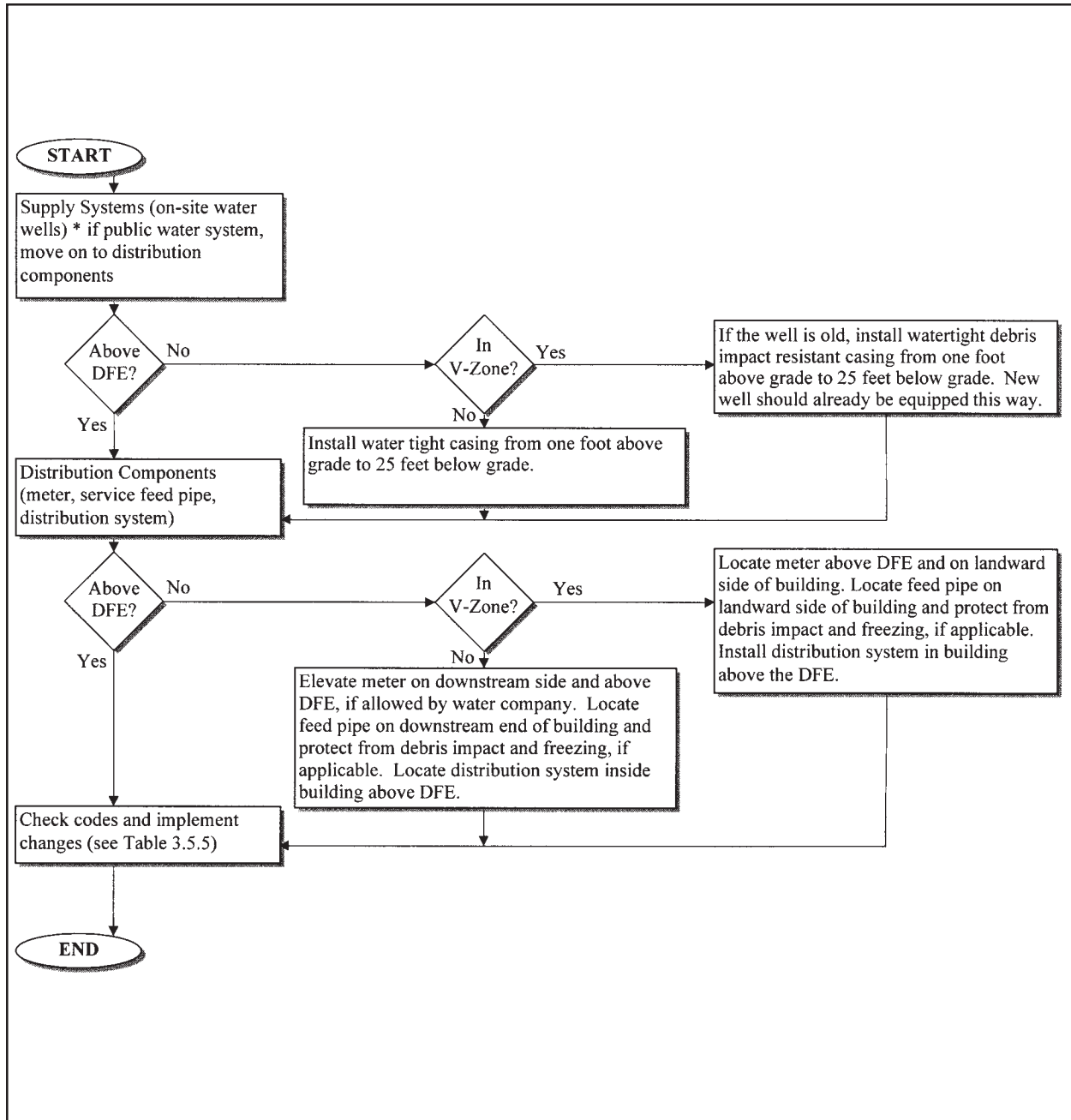
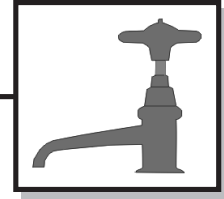


Figure 3.5.5: Flow chart of flood resistant sewage management system design

**New and Substantially Improved Buildings**  
**Potable Water Systems**



**FLOOD RESISTANT POTABLE WATER SYSTEM CHECKLIST**

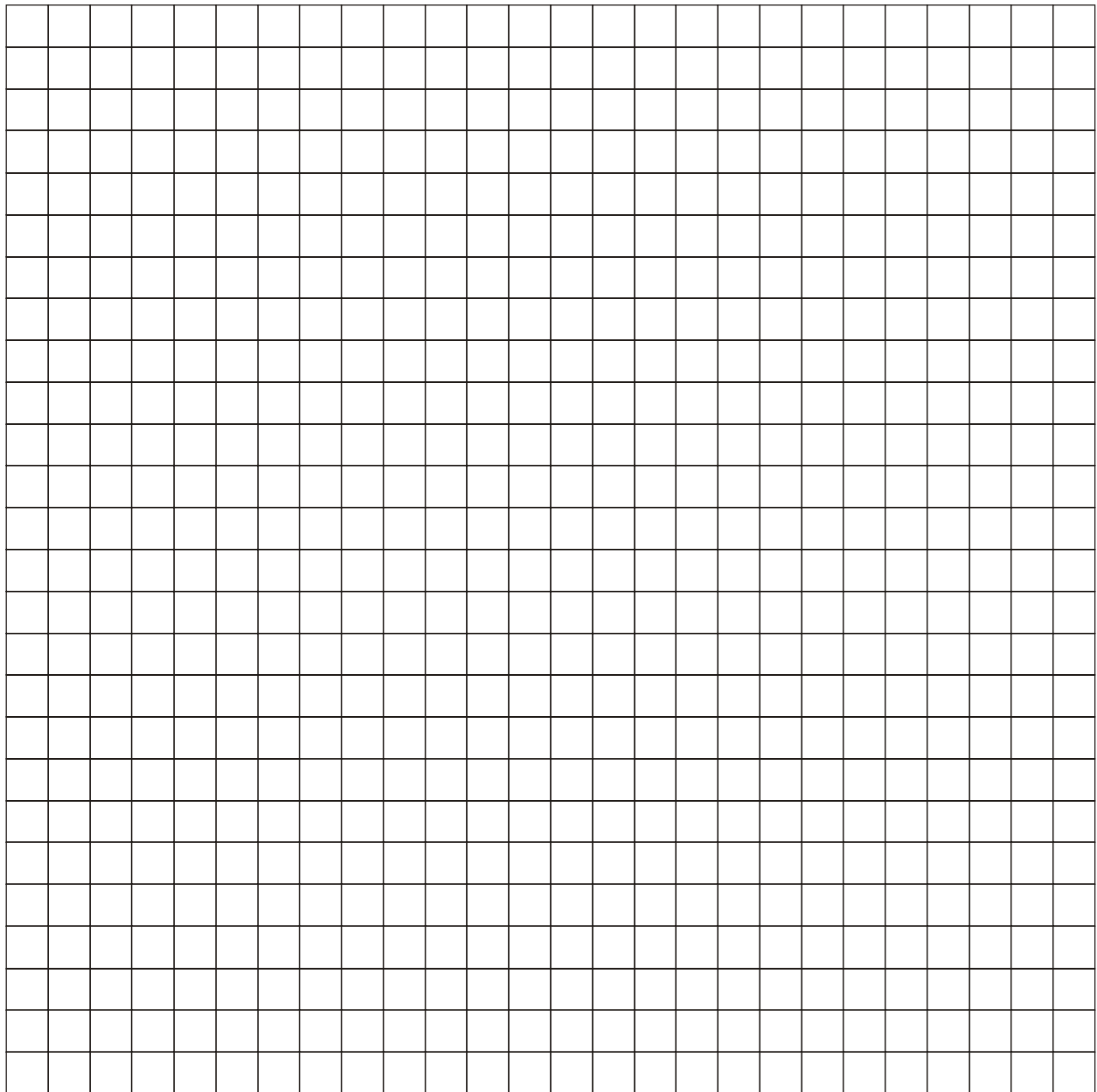
Property ID:		Property Contact:						
Property Name:		Interviewed:						
Property Address:		Phone:						
Surveyed By:		Date Surveyed:						
DFE:								
<ul style="list-style-type: none"> <li>What type of water supply system is used for the building?           <table border="0" style="width: 100%;"> <tr> <td style="width: 50%; vertical-align: top;"> <input type="checkbox"/> On-site            Is the well head above the DFE? <input type="checkbox"/> Y <input type="checkbox"/> N            Is the well protected from impact? <input type="checkbox"/> Y <input type="checkbox"/> N            Is the feed pipe protected from impact? <input type="checkbox"/> Y <input type="checkbox"/> N            Is the pressure tank above the DFE? <input type="checkbox"/> Y <input type="checkbox"/> N         </td> <td style="width: 50%; vertical-align: top;"> <input type="checkbox"/> Off site            Is the feed pipe protected from impact? <input type="checkbox"/> Y <input type="checkbox"/> N            Is meter protected from <input type="checkbox"/> Flood? <input type="checkbox"/> Frost?  <input type="checkbox"/> Impact?         </td> </tr> </table> </li> </ul>				<input type="checkbox"/> On-site Is the well head above the DFE? <input type="checkbox"/> Y <input type="checkbox"/> N Is the well protected from impact? <input type="checkbox"/> Y <input type="checkbox"/> N Is the feed pipe protected from impact? <input type="checkbox"/> Y <input type="checkbox"/> N Is the pressure tank above the DFE? <input type="checkbox"/> Y <input type="checkbox"/> N	<input type="checkbox"/> Off site Is the feed pipe protected from impact? <input type="checkbox"/> Y <input type="checkbox"/> N Is meter protected from <input type="checkbox"/> Flood? <input type="checkbox"/> Frost? <input type="checkbox"/> Impact?			
<input type="checkbox"/> On-site Is the well head above the DFE? <input type="checkbox"/> Y <input type="checkbox"/> N Is the well protected from impact? <input type="checkbox"/> Y <input type="checkbox"/> N Is the feed pipe protected from impact? <input type="checkbox"/> Y <input type="checkbox"/> N Is the pressure tank above the DFE? <input type="checkbox"/> Y <input type="checkbox"/> N	<input type="checkbox"/> Off site Is the feed pipe protected from impact? <input type="checkbox"/> Y <input type="checkbox"/> N Is meter protected from <input type="checkbox"/> Flood? <input type="checkbox"/> Frost? <input type="checkbox"/> Impact?							
Where is the water heater located? Elevation:								
Are any fixtures located below the DFE? <input type="checkbox"/> Yes <input type="checkbox"/> No Description/elevation:								
What piping is located below the DFE? And what type.								
<ul style="list-style-type: none"> <li>What equipment is located below the DFE?           <table border="0" style="width: 100%;"> <tr> <td style="width: 25%;"><input type="checkbox"/> Meter</td> <td style="width: 25%;"><input type="checkbox"/> Well Head</td> <td style="width: 25%;"><input type="checkbox"/> Water Heater</td> <td style="width: 25%;"><input type="checkbox"/> Fixtures</td> <td style="width: 25%;"><input type="checkbox"/> Piping</td> </tr> </table> </li> </ul>				<input type="checkbox"/> Meter	<input type="checkbox"/> Well Head	<input type="checkbox"/> Water Heater	<input type="checkbox"/> Fixtures	<input type="checkbox"/> Piping
<input type="checkbox"/> Meter	<input type="checkbox"/> Well Head	<input type="checkbox"/> Water Heater	<input type="checkbox"/> Fixtures	<input type="checkbox"/> Piping				
<input type="checkbox"/> Other:		<input type="checkbox"/> Other:						

Table 3.5.5: Checklist for flood resistant sewage management system design



**New and Substantially Improved Buildings**  
**Potable Water Systems**

**Sketch sheet**  
**(for details, notes, or data regarding system installations)**



**CONTENTS**

	<b>Page</b>
4.0 Introduction	4-2
4.1 Methods of Floodproofing Existing Utility Systems by Retrofitting	4-3
4.2 Field Investigation	4-4
4.3 Retrofitting Scenarios	4-8

**FIGURES**

Figure 4.1A: Elevated air conditioning compressor	4-3
Figure 4.1B: Flood enclosure to protect utilities from shallow flooding	4-3
Figure 4.2: Retrofitting field investigation worksheet	4-5

**TABLE**

Table 4.3: Special concerns for five building types	4-8
---	-----



This chapter does not apply to substantially damaged or substantially improved buildings. See Section 2.4 for further information.



Although the NFIP does not require non-substantially improved buildings to meet the same criteria as those required of new and substantially improved buildings, every retrofitting project in flood-proofing should, to the greatest extent possible and practical, meet or even exceed the requirements of the NFIP.



For information on the determination of substantial damage, refer to Section 2.4.

## 4.0 Introduction

Utilities in existing buildings can often be effectively protected from flood damage. The easiest and most practical time to undertake this effort is during a renovation or repair project. If the building has been substantially damaged and/or the building is being substantially improved, the National Flood Insurance Program (NFIP) requires that the building support utility systems be protected from flood damage to the criteria required for new construction as outlined in Chapter 3. However, in many circumstances, a building will suffer damage that does not result in the structure being substantially damaged. In those cases, the owner is provided with three basic options for repairing the building.

- **Replace the system with a like system** – This option is typically the cheapest option, but provides no improved protection from future flood damage
- **Implement low-cost retrofits similar to those recommended in this chapter** – These options can cost more than replacement of the system with a like system, but for a minimal additional cost, large benefits may be realized especially when protecting from smaller future flooding events.
- **Mitigate future damage using the standards outlined in Chapter 3** – These options typically protect the system from future damage through elevation or protection of the system in place. This option is usually the most costly, but it can protect the owner from the inconvenience of repeated future flood damages.

Even where a retrofitting project is not required to meet the minimum NFIP standards for new and improved structures, it is still worth implementing measures that make an existing utility system more resistant to future flood damage.

If utilities are severely damaged, a structurally sound residence may be rendered uninhabitable due to unsafe or unsanitary conditions. As a result, moderately priced measures for protecting utilities are often considered cost effective by allowing the residence to remain habitable. For example, it is worth elevating an air conditioning or heat pump compressor to a higher level, even if the compressor still remains below the Design Flood Elevation (DFE); since it would at least be safe from lower-level floods.



### 4.1 Methods of Floodproofing Existing Utility Systems by Retrofitting

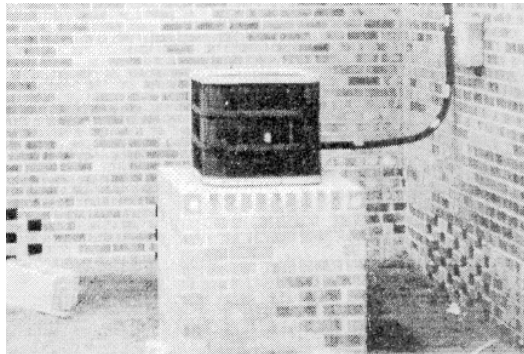
Retrofitting building support utility systems involves a combination of adjustments or additions to features of existing building support utility systems that are intended to eliminate or reduce the possibility of flood damage. Retrofitting measures include the following:

- **Elevation/Relocation** - The elevation of components of an existing building support utility system on a cantilevered platform, fill or foundation elements such as solid walls, piers, posts, columns, or piling is the most common type of component protection in shallow flooding areas. *Figure 4.1A* shows an air conditioning compressor elevated atop a pedestal. Elevation also includes relocation of components of an existing utility system to a higher location such as a higher floor of the building or to a utility building or platform that is located at a higher elevation.



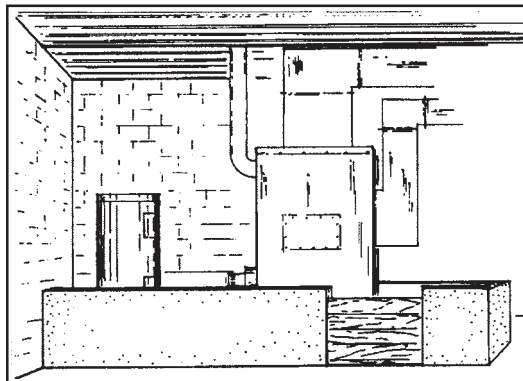
This chapter does not apply to substantially damaged or substantially improved buildings. See Section 2.4 for further information.

**Figure 4.1A:**  
Elevated air conditioning compressor



- **Component Protection** - Making utility components flood damage-resistant and water-resistant during periods of flooding within the structure. *Figure 4.1B* shows a flood enclosure that is used to protect utilities from shallow flooding.

**Figure 4.1B:**  
Flood enclosure to protect utilities from shallow flooding





This chapter does not apply to substantially damaged or substantially improved buildings. See Section 2.4 for further information.

Retrofitting measures can either be passive or active in terms of necessary human intervention. Active and emergency retrofitting measures are effective only if there is sufficient warning time to mobilize the labor and equipment necessary to implement the measures. Therefore, every effort should be made to design retrofitting measures that are passive and do not require human intervention.

It is important to note that where elevation above the DFE is not possible or practical, it may be feasible to combine elevation with component protection. A component can be elevated to a higher level and then shielded for added protection. Even a small increase in elevation can reduce future flood damage.

### 4.2 Field Investigation

Prior to the start of a retrofitting project, a field investigation should be conducted to gather detailed information that can be used to make decisions concerning the feasibility of the project and which method of flood damage protection should be used. *Figure 4.2* is a worksheet that provides the basic format for a field investigation. In addition to the information in the worksheet, the following issues should also be examined:

- Previous floods, which equipment was flooded in prior floods, and which appliances and circuits were affected by previous floods.
- Plan of action as to which equipment can be relocated and which equipment will have to remain located below the DFE.
- Length of power outage, water shut-off, or fuel shut-off while work is being done.
- Unsafe practices and code violations by current design.

#### NOTE:

The Design Flood Elevation (DFE) is a regulatory flood elevation adopted by a community that is the BFE, at a minimum, and may include freeboard, as adopted by the community.





Owner Name: \_\_\_\_\_ Prepared By: \_\_\_\_\_  
Address: \_\_\_\_\_ Date: \_\_\_\_\_  
Property Location: \_\_\_\_\_

### Flood Resistant Retrofitting Field Investigation Worksheet

Design Flood Elevation (DFE) \_\_\_\_\_

#### HVAC System

- Can all equipment be protected in-place? \_\_\_Yes\_\_\_No
- Is it feasible to install a curb or “pony” wall around equipment to act as a barrier? \_\_\_Yes\_\_\_No
- Is it feasible to construct a waterproof vault around equipment below the DFE? \_\_\_Yes\_\_\_No
- Can reasonably sized sump pumps keep water away from the equipment? \_\_\_Yes\_\_\_No
- Can equipment feasibly be relocated?
- To a pedestal or balcony above the DFE? \_\_\_Yes\_\_\_No
- To a higher level on the same floor level? \_\_\_Yes\_\_\_No
- To the next floor level? \_\_\_Yes\_\_\_No
- Is space available for the equipment in the alternate location? \_\_\_Yes\_\_\_No
- Can existing spaces be modified to accept equipment? \_\_\_Yes\_\_\_No
- Is additional space needed? \_\_\_Yes\_\_\_No
- Do local codes restrict such relocations? \_\_\_Yes\_\_\_No

#### Fuel System

- Can all equipment be protected in-place? \_\_\_Yes\_\_\_No
- Is the tank properly protected against horizontal and vertical forces from velocity flow and buoyancy? \_\_\_Yes\_\_\_No
- Is it feasible to install a curb or “pony” wall around equipment to act as a barrier? \_\_\_Yes\_\_\_No
- Is it feasible to construct a waterproof vault around equipment below the DFE? \_\_\_Yes\_\_\_No
- Can reasonably sized sump pumps keep water away from the equipment? \_\_\_Yes\_\_\_No
- Is the meter properly protected against velocity and impact forces? \_\_\_Yes\_\_\_No

Figure 4.2: Retrofitting field investigation worksheet (page 1 of 3)



- Do local code officials and the gas company allow the meter to be relocated to a higher location? \_\_\_Yes\_\_\_No
- Can equipment feasibly be relocated?
- To a pedestal or balcony above the DFE? \_\_\_Yes\_\_\_No
- To a higher level on the same floor level? \_\_\_Yes\_\_\_No
- To the next floor level? \_\_\_Yes\_\_\_No
- Is space available for the equipment in the alternate location? \_\_\_Yes\_\_\_No
- Can existing spaces be modified to accept equipment? \_\_\_Yes\_\_\_No
- Is additional space needed? \_\_\_Yes\_\_\_No
- Do local codes restrict such relocations? \_\_\_Yes\_\_\_No

### Electrical System

- Is it feasible to relocate the meter base and service lateral above the DFE? \_\_\_Yes\_\_\_No
- Is it feasible to relocate the main panel and branch circuits above the DFE? \_\_\_Yes\_\_\_No
- Is it feasible to relocate appliances, receptacles, and circuits above the DFE? \_\_\_Yes\_\_\_No
- Is it feasible to relocate light switches and receptacles above the DFE? \_\_\_Yes\_\_\_No
- Can ground fault interrupter protection be added to circuits below the DFE? \_\_\_Yes\_\_\_No
- Can service lateral outside penetrations be sealed to prevent water entrance? \_\_\_Yes\_\_\_No
- Can cables and/or conduit be mechanically fastened to prevent damage during flooding? \_\_\_Yes\_\_\_No
- Can splices and connections be made water resistant or relocated above the DFE? \_\_\_Yes\_\_\_No
- Do local code officials and electric companies allow the elevation of the meter? \_\_\_Yes\_\_\_No

### Sewage Management Systems

- Can the on-site system be protected in-place? \_\_\_Yes\_\_\_No
- Is it feasible to anchor the tank? \_\_\_Yes\_\_\_No
- Can the distribution box and leech field be protected from scour and impact forces? \_\_\_Yes\_\_\_No

Figure 4.2: Retrofitting field investigation worksheet (page 2 of 3)

## Existing Buildings



- Can the supply lines be properly protected from scour and impact forces? \_\_\_Yes\_\_\_No
- Can backflow prevention valves be used to minimize flow of sewage into the building? \_\_\_Yes\_\_\_No
- Can equipment feasibly be relocated?
- Can the system be moved to a higher elevation on the property? \_\_\_Yes\_\_\_No
- Can the tank be relocated to a higher elevation or indoors? \_\_\_Yes\_\_\_No
- Can the drains and toilets be relocated above the DFE? \_\_\_Yes\_\_\_No
- Is space available for the equipment in the alternate location? \_\_\_Yes\_\_\_No
- Can existing spaces be modified to accept equipment? \_\_\_Yes\_\_\_No
- Is additional space needed? \_\_\_Yes\_\_\_No
- Do local codes restrict such relocations? \_\_\_Yes\_\_\_No

### Potable Water Systems

- Can the well be protected in-place? \_\_\_Yes\_\_\_No
- Is it feasible to install a curb or “pony” wall around equipment to act as a barrier? \_\_\_Yes\_\_\_No
- Is it feasible to construct a waterproof vault around equipment below the DFE? \_\_\_Yes\_\_\_No
- Can the wellhead and tank be protected from scour and impact forces? \_\_\_Yes\_\_\_No
- Can the supply lines be properly protected from scour and impact forces? \_\_\_Yes\_\_\_No
- Can backflow prevention valves be used to minimize flow of floodwaters into the water source? \_\_\_Yes\_\_\_No
- Can equipment feasibly be relocated?
- Can the well be moved to a higher elevation on the property? \_\_\_Yes\_\_\_No
- Can the electric controls for the well be protected from inundation? \_\_\_Yes\_\_\_No
- Can the tank be relocated to a higher elevation or indoors? \_\_\_Yes\_\_\_No
- Can the taps be relocated above the DFE? \_\_\_Yes\_\_\_No
- Is space available for the equipment in the alternate location? \_\_\_Yes\_\_\_No
- Can existing spaces be modified to accept equipment? \_\_\_Yes\_\_\_No
- Is additional space needed? \_\_\_Yes\_\_\_No
- Do local codes restrict such relocations? \_\_\_Yes\_\_\_No

Figure 4.2: Retrofitting field investigation worksheet (page 3 of 3)



### 4.3 Retrofitting Scenarios

#### Overview

This section outlines basic retrofitting scenarios. In addition to the basic concerns outlined later in this section, additional concerns may exist for particular building types. *Table 4.3* shows the five basic types of buildings and identifies issues that may be of particular concern for the building types.

**NOTE:**

In every retrofitting project, it is imperative to ensure that the impact of the retrofitting measures upon the existing building and its attendant utilities is thoroughly investigated and assessed to ensure that the project meets the local building code and floodplain management requirements. It may be necessary to make structural and other modifications in order to accommodate the retrofitting measures.

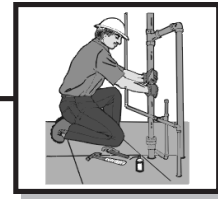
**CAUTION:**

This chapter does not apply to substantially damaged or substantially improved buildings. See Section 2.4 for further information.

	House on basement/ split level/bi-level	Slab-on-grade	Crawlspace	Elevated foundation	Garage
Ensure that exterior HVAC system components are sufficiently protected from debris impact, velocity flow, wave action, erosion, scour, and wind and water inundation	✓	✓	✓	✓	
Ensure that ductwork located below the DFE is relocated or protected to prevent water infiltration	✓		✓	✓	
Ensure that water heaters and boilers are protected or relocated to prevent inundation by floodwaters	✓	✓	✓	✓	
Ensure that exterior fuel tanks are properly protected against erosion, scour, buoyancy, debris impact, velocity flow, and wave action.	✓	✓	✓	✓	✓
Ensure that interior fuel tank is properly protected against buoyancy and impact forces	✓				✓
Electrical equipment located below the DFE should be protected from inundation	✓			✓	✓
Ensure that wiring is relocated above the DFE, or that wires below the DFE are installed to minimize the risk of water infiltration and damage	✓		✓	✓	✓
Ensure that electrical components located below the DFE are not attached to breakaway walls of buildings in V Zones				✓	
Ensure that water and sewer lines are protected from backflow	✓	✓			
Ensure all water, sewer and fuel pipes are adequately protected to prevent damage caused by erosion, scour, debris impact, velocity flow, and wave action	✓	✓	✓	✓	

Table 4.3: Special concerns for five building types

## Existing Buildings



The scenarios that begin on the next page generally have options listed in order of the most to the least preferred flood protection approaches for HVAC Systems, Fuel Systems, Electrical Systems, Sewage Management Systems, and Potable Water Systems. Typically, the most preferred option is presented and then several other options are explored. Note that this section only applies to retrofitting of existing buildings that are not substantially damaged or substantially improved. Refer to Sections 3.1 through 3.5 for a detailed explanation of flood resistant building utility systems for new, substantially damaged, or substantially improved buildings. In addition, Sections 3.1 through 3.5 contain many figures that might be helpful for visualization of the various retrofit scenarios located in this chapter.

### Evaluation of Risk

For buildings constructed in the floodplain, there is a risk of serious flood damage to most, if not all, building utility systems constructed below the DFE. The level of risk depends on several factors, including the number of utility systems located below the DFE and their location relative to the building footprint.

### Analysis of Various Utility Systems

#### 1. Heating, Ventilating, and Air Conditioning (HVAC) Systems

- a. Compressor, heat pump, and other outdoor equipment:
  - Is expected flooding shallow enough that the equipment can be put up on a pedestal?
  - If not, can the equipment be moved to a porch or other location above the DFE?
  - If not, construct a balcony to elevate the equipment.
  - If the building is located in a shallow flood area, can a dry floodproof enclosure be built around the equipment?
- b. Furnace, boiler, water heater, and other indoor equipment:
  - Can the equipment be moved to a location above the DFE that is accessible to the duct work?
  - If not, can the equipment be elevated above the DFE on a pedestal at its present location?



This chapter does not apply to substantially damaged or substantially improved buildings. See Section 2.4 for further information.



Refer to Section 3.1.3 of this manual for an illustration of a flood shield.



- If not, can a lateral furnace be suspended from the basement ceiling above the DFE or placed in the attic? (Note: there is an additional cost associated with replacing a traditional furnace with a lateral furnace; however, a lateral furnace can be protected from future flood damage.)
  - If not, place the equipment on a pedestal inside the house as high as possible, even if the equipment elevation remains below the DFE.
  - If the building is located in a shallow flood area, can a dry floodproof enclosure be built around the equipment?
- c. Fuel pipes and electrical wiring: see the discussion of Fuel Systems and Electrical Systems that follow for appropriate protection measures.
- d. Air ducts:
- Can the duct work be elevated above the DFE?
  - If not, can the ducts below the DFE be replaced with watertight ducts? This option may be very expensive, but can be cost-effective in some applications.
  - If not, make sure the ducts below the DFE are accessible and can be disassembled for thorough cleaning. (Note: if the ducts are not protected from flooding, then they must be thoroughly cleaned after a flood. Sediment and contaminants in the ducts can be circulated through the HVAC system if it is operated with dirty ducts.)
  - Can return and supply registers be located above the DFE?
  - If not, the ducts leading to the registers should be designed to allow ample access for cleaning, thorough drainage, and be installed without insulation to prevent mold growth in the ducts.



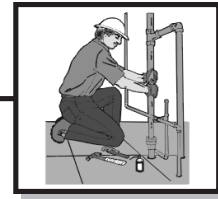
## 2. Fuel Systems

- a. Fuel storage tank (if applicable):
- Is the above-ground tank properly protected from buoyancy and impact forces?
  - If not, can the equipment be elevated above the DFE on a pedestal?
  - If not, can the equipment be elevated above the DFE on structural fill?

### NOTE:

Refer to Section 3.2.3.1 of this manual for a discussion of buoyancy forces.

## Existing Buildings



- If not, can the tank be buried and anchored?
- If not, can the tank be relocated inside a building?
- If not, replace the tank with an above ground vault.

### b. Outdoor pipes:

- Are all pipes above the DFE?
- If not, strap them to the downstream or landward side of a building support and encase them with pipe or a chase to protect them from scour and impact forces.
- Are all pipe penetrations above the DFE?
- If not, make them watertight and use thick walled metallic piping to resist ground movement.

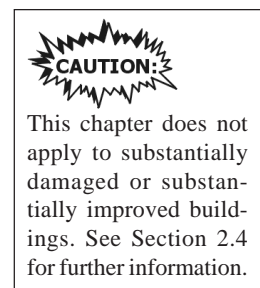
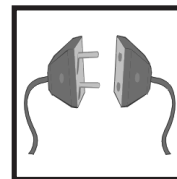
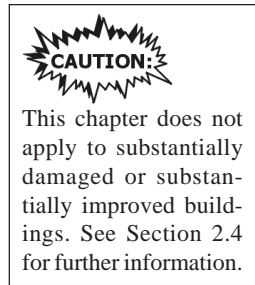
## 3. Electrical Systems

### a. System equipment (meter, main service panel, breaker and fuse boxes, and transformer):

- Is all system equipment located above the DFE?
- If not, can all of the equipment be relocated above the DFE?
- If not, move the equipment as high as possible, even if the equipment elevation remains below the DFE.

### b. Distribution system (wiring, receptacles, outlets and switches):

- Are all system components located above the DFE?
- If not, can all receptacles, outlets and switches below the DFE be elevated or removed?
- If not, place the receptacles remaining below the DFE on one or two separate circuits. Install and clearly identify ground fault circuit interrupter breakers on those circuits. (Note: receptacles and switches below the DFE should be installed in non-corrosive boxes with holes punched in the bottom to facilitate drying. The receptacles will have to be replaced after inundation by floodwaters.)







### NOTE:

Refer to Section 3.4.4 of this manual for an illustration of a combination check and gate valve.



This chapter does not apply to substantially damaged or substantially improved buildings. See Section 2.4 for further information.



#### 4. Sewage Management Systems

- a. Install an appropriate sewer backup control measure:
  - Are all collection system components located above the DFE?
  - If not, can all collection system components within the building be elevated above the DFE?
  - If not, install a non-return backflow valve or a combination of check and gate valves in the public sewer service connection pipe to protect against sewage backup.
- b. Protect all external pipes and building penetrations. Refer to Fuel Systems discussion in Section 3.2 for details.
- c. A plug should be installed in all sewer openings below the DFE (e.g., toilet or sink drain) to prevent sewage from backflowing into the building.
- d. Septic tank (if applicable):
  - Is the septic system located above the DFE?
  - If not, seal the septic tank to prevent contamination of the floodwaters by the contents of the tank.
  - If not, anchor or otherwise prevent the tank from becoming buoyant. Refer to Section 3.2.3.1 for a comprehensive look at buoyancy forces.
  - If not, protect the tank from erosion and scour.

#### 5. Potable Water Systems

- a. Plumbing fixtures (outdoor faucets, shower heads, and utility sinks):
  - Are all plumbing fixtures located above the DFE?
  - If not, can they all be elevated above the DFE?
  - If not, install back-flow valves on pipelines leading to fixtures or on the fixtures located below the DFE to prevent floodwaters from contaminating the water supply.
- b. Protect all external pipes and building penetrations from impact and scour forces and leakage.
- c. Seal the well top using a watertight casing to prevent inflow and contamination. Also, protect the well top from scour and impact forces that could damage it and breach the water supply system.

### Bibliography and Sources of Information

FEMA and other organizations have produced many documents about floodproofing and flood hazard mitigation. Those listed below provide information that may be useful.

#### Federal Emergency Management Agency

*Homeowners Guide to Retrofitting - Six Ways To Protect Your House From Flooding*, FEMA 312, June 1998  
<http://www.fema.gov/mit/rfit/>

*Engineering Principles and Practices for Retrofitting Flood Prone Residential Buildings*, FEMA 259, January 1995

*Mitigation of Flood and Erosion Damage to Residential Buildings in Coastal Areas*, FEMA 257, October 1994

*Interim Guidance for State and Local Officials: Increased Cost of Compliance Coverage*, FEMA 301, September 1997

*Guidance on Estimating Substantial Damage Using the NFIP, Substantial Damage Estimating*, FEMA 311

*Answers to Questions About Substantially Damaged Buildings*, FEMA-213, May 1991

*Floodproofing Non-Residential Structures*, FEMA 102, May 1986

FEMA Technical Bulletins:  
<http://www.fema.gov/mit/techbul.htm>

*User's Guide*

*Openings in Foundation Walls (FIA-TB-1)*

*Flood-Resistant Material Requirements (FIA-TB-2)*

*Non-Residential Floodproofing - Requirements and Certification (FIA-TB-3)*

*Elevator Installation (FIA-TB-4)*

*Free-of-Obstruction Requirements (FIA-TB-5)*

**NOTE:**

FEMA publications can be ordered from FEMA's Publication Office at:  
**1-800-480-2520**



## Appendix A - Bibliography and Sources of Information

---

*Below-Grade Parking Requirements* (FIA-TB-6)

*Wet Floodproofing Requirements* (FIA-TB-7)

*Corrosion Protection for Metal Connectors in Coastal Areas* (FIA-TB-8)

*Design and Construction Guidance for Breakaway Walls Below Coastal Buildings* (FIA-TB-9)

**Federal Emergency Management Agency and the American Red Cross**, *Repairing Your Flooded Home*, FEMA 234 and ARC 4477, August 1992

**Federal Emergency Management Agency and the National Association of Home Builders**, *Best Build 3: Protecting a Flood-Prone Home* (30-minute video)

**Florida Department of Community Affairs**, Division of Emergency Management, Bureau of Recovery and Mitigation, State Assistance Office for the NFIP, *Retrofitting and Flood Mitigation in Florida*, January 1995

**Illinois Department of Transportation, Division of Water Resources**  
*Flooded Basements: A Homeowner's Guide*, August Edition, 1992

*Flood Hazard Mitigation*, May 1988

*Protect Your Home from Flood Damage*, January 1985

*Elevating or Relocating a House to Reduce Flood Damage*, Local Assistance Series 3C, revised 1986

**Illinois Department of Transportation, Division of Water Resources, and University of Illinois, Small Homes Council - Building Research Council**, *Elevating Flood-Prone Buildings: A Contractor's Guide*, Local Assistance Series 3D, undated

**U.S. Army Corps of Engineers**

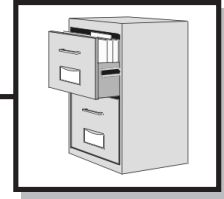
*Flood-Proofing Regulations*, EP 1165-2-314, December 15, 1995

*A Flood Proofing Success Story Along Dry Creek at Goodlettsville, Tennessee*, April 1995

*Local Flood Proofing Programs*, June 1994

## Appendix A - Bibliography and Sources of Information

---



*Flood Proofing - How to Evaluate Your Options*, July 1993

*Flood Proofing Techniques, Programs, and References*, February 1991

*Flood Proofing Performance, Successes & Failures*, December 1998

*Raising and Moving a Slab-on-Grade House*, 1990

*Flood Proofing Tests, Tests of Materials and Systems for Flood Proofing Structures*, August 1988

*Flood Proofing Systems and Techniques*, December 1984

For information about natural hazards and hazard mitigation, visit the Internet sites listed below:

**American Red Cross**

<http://www.crossnet.org/>

**American Society of Civil Engineers (ASCE)**

<http://www.asce.org/>

**American Society of Heating, Refrigeration and Air Conditioning Engineers**

<http://www.ashrae.org/>

**Applied Technology Council**

<http://www.atcouncil.org/>

**Association of State Floodplain Managers**

<http://www.floods.org>

**Disaster Research Center, University of Delaware**

<http://www.udel.edu/DRC/>

**Earthquake Hazards Mitigation Information Network**

<http://www.eqnet.org/index.html>

**Federal Emergency Management Agency**

<http://www.fema.gov>

**Gas Appliance Manufacturer's Association**

<http://www.gamanet.org>

**Hazard Reduction and Recovery Center (HRRC), Texas A&M**

<http://chud.tamu.edu/hrrc/hrrc-home.html>



## Appendix A - Bibliography and Sources of Information

---

**National Association of Home Builders**

<http://www.nahb.com/>

**National Electrical Manufacturers Association (NEMA)**

<http://www.nema.org/>

**National Association of Plumbing & Heating-Cooling Contractors**

<http://www.naphcc.org/>

**National Geophysical Data Center / WDC-A for Solid Earth  
Geophysics, Boulder, Colorado**

<http://www.ngdc.noaa.gov/seg/hazard/hazards.html>

**National Information Service for Earthquake Engineering, University  
of California at Berkeley**

<http://nisee.ce.berkeley.edu/>

**Natural Hazards Center at the University of Colorado, Boulder, Colorado**

<http://www.colorado.edu/hazards/>

**U.S. Geological Survey - Earthquake Hazards and Preparedness**

<http://quake.wr.usgs.gov/hazprep>

**U.S. Natural Resources Conservation Service**

<http://www.nrcs.usda.gov/>

**Wind Engineering Research Center, Texas Tech University**

[http:// www.ce.ttu.edu/wind/main.html](http://www.ce.ttu.edu/wind/main.html)

### Glossary of Terms

Many of the terms defined here are also defined in the margins of pages on which they first appear or explained in the body of the text.

**A-Zones** See “Special Flood Hazard Area.”

**Active retrofitting method**

Method that will not function as intended without human intervention. See "Passive retrofitting method."

**Adjacent grade** See "Lowest Adjacent Grade."

**Alluvial fan flooding**

Flooding that occurs on the surface of an alluvial fan (or similar landform) that originates at the apex of the fan and is characterized by high-velocity flows; active processes of erosion, sediment transport, and deposition; and unpredictable flow paths.

**Armor** To protect fill slopes, such as the sides of a levee, by covering them with erosion-resistant materials such as rock or concrete.

**Alluvial fan** Area of deposition where steep mountain drainages empty into valley floors, usually in arid regions. Flooding in these areas often includes characteristics that differ from those in riverine or coastal areas.

**Backfill** To fill in a hole with the soil removed from it or with other material, such as soil, gravel, or stone.

**Backflow valve** See “Check valve.”

**Base flood** Flood that has a 1-percent probability of being equaled or exceeded in any given year. Also known as the 100-year flood.

**Base Flood Elevation (BFE)**

Elevation of the 100-year flood. The BFE is determined by statistical analysis for each local area and is designated on the FIRMs. This elevation is the basis of the insurance and floodplain management requirements of the NFIP.

**Basement**

As defined by the NFIP regulations, any area of a building having its floor subgrade (below ground level) on all sides.

**Breakaway wall** Walls enclosing the area below an elevated structure that are designated to break away before transmitting damaging forces to the structure and its foundation. Breakaway walls are required by the NFIP regulations in coastal high-hazard areas (V-Zones) and are recommended in areas where flood waters could flow at significant velocities (usually greater than four feet per second) or could contain ice or other debris.

**Cast-in-place concrete**

Concrete poured and formed at the construction site.

**Caulking**

Material used to fill joints in a structure, such as around windows or doors.

**Check valve**

Valve that allows water to flow in one direction but automatically closes when the direction of flow is reversed.

**Closure**

Shield made of strong material, such as metal or wood, used to temporarily close openings in levees, floodwalls, and dry floodproofed buildings.

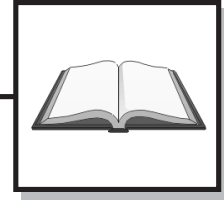
**Coastal High Hazard Area**

Area of special flood hazard (designated Zone V, VE, or V1 - V30 on a FIRM) that extends from offshore to the inland limit of a primary frontal dune along an open coast, and any other area subject to high-velocity wave action from storms or seismic sources.



## Appendix B - Glossary of Terms

---



<b>Column</b>	Upright support units for a building, set in pre-dug holes and backfilled with compacted material. Columns will often require bracing in order to provide adequate support. They are also known as posts, although posts are usually of concrete masonry construction.
<b>Compaction</b>	In construction, the process by which the density of earth fill is increased so that it will provide a sound base for a building or other structure.
<b>Crawl space</b>	Type of foundation in which the lowest floor of a house is elevated above the ground on continuous foundation walls, creating an uninhabitable enclosed area.
<b>Cribbing</b>	Temporary supports usually consisting of layers of heavy timber.
<b>Datum plane</b>	See "Elevation datum plane."
<b>Debris</b>	Materials carried by floodwaters, including objects of various sizes and suspended soils.
<b>Design capacity</b>	Volume of water that a channel, pipe, or other drainage line is designed to convey.
<b>Design Flood Elevation (DFE)</b>	The elevation of the highest flood (generally the BFE including freeboard) that a retrofitting method is designed to protect against. Also referred to as Flood Protection Elevation.
<b>Dry floodproofing</b>	Protecting a building by sealing its exterior walls to prevent the entry of flood waters.
<b>Elevation</b>	In retrofitting, the process of raising a house or other building so that it is above the height of a given flood.

**Elevation datum plane**

Arbitrary surface that serves as a common reference for the elevations of points above or below it. Elevations are expressed in terms of feet, meters, or other units of measure and are identified as negative or positive depending on whether they are above or below the datum plane.

**Erosion**

The wearing away of soil by moving water.

**Existing construction**

The structures already existing or under construction prior to the effective date of the initial Flood Insurance Rate Map.

**Federal Emergency Management Agency (FEMA)**

Independent agency created in 1978 to provide a single point of accountability for all Federal activities related to disaster mitigation and emergency preparedness, response, and recovery. FEMA administers the NFIP.

**Federal Insurance Administration (FIA)**

Component of FEMA directly responsible for administering the flood insurance aspects of the NFIP.

**Fill**

Material such as soil, gravel, or crushed stone which is dumped in an area and to increase the ground elevation. Fill is usually placed in layers and compacted (see "Compaction").

**Flap valve**

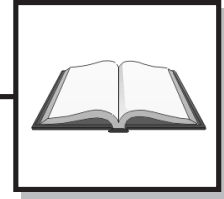
See "Check valve."

**Flash flood**

Flood that rises very quickly and usually is characterized by high flow velocities. Flash floods often result from intense rainfall over a small area.

## Appendix B - Glossary of Terms

---



- Flood** Under the NFIP, a partial or complete inundation of normally dry land areas from 1) the overland flow of a lake, river, stream, ditch, etc., 2) the unusual and rapid accumulation or runoff of surface waters; and 3) mudflows or the sudden collapse of shoreline land.
- Flood depth** Height of flood waters above the surface of the ground at a given point.
- Flood duration** Amount of time between the initial rise of flood, including freeboard, waters and their recession.
- Flood elevation** Height of flood waters above an elevation datum plane.
- Flood frequency** Probability, expressed as a percentage, that a flood of a given size will be equaled or exceeded in any given year. The flood that has a 1-percent probability (1 in 100) of being equaled or exceeded in any given year is often referred to as the 100-year flood. Similarly, the floods that have a 2-percent probability (1 in 50) and a 0.2-percent (1 in 500) of being equaled or exceeded in any year are referred to as the 50-year flood and the 500-year flood, respectively.
- Flood fringe** That portion of the floodplain that lies beyond the floodway and serves as a temporary storage area for flood waters during a flood. This section receives waters that are shallower and of lower velocities than those of the floodway.
- Flood Hazard Boundary Map (FHBM)**  
The official map of a community that shows the boundaries of the floodplain and special flood hazard areas that have been designated. It is prepared by FEMA using the best flood data available at the time a community enters the emergency phase of the NFIP. It is superseded by the FIRM after a more detailed study has been completed.

**Flood Insurance Rate Map (FIRM)**

The official map of a community prepared by FEMA that shows the BFE, along with the special flood hazard areas and the risk premium zones for flood insurance purposes. Once it has been accepted, the community is part of the regular phase of the NFIP.

**Flood Insurance Study (FIS)**

A study performed by any of a variety of agencies and consultants to delineate the special flood hazard areas, base flood elevations, and risk premium zones. The study is funded by FEMA and is based on detailed site surveys and analysis of the site-specific hydrologic characteristics.

**Floodplain**

Any area susceptible to inundation by water from any source. See "Regulatory floodplain."

**Floodplain management**

Program of corrective and preventive measures for reducing flood damage, including flood control projects, floodplain land use regulations, floodproofing or retrofitting of buildings, and emergency preparedness plans.

**Floodproofing**

Structural or nonstructural changes or adjustments included in the design, construction, or alteration of a building that reduce damage to the building and its contents from flooding and erosion. See "Dry floodproofing" and "Wet floodproofing."

**Floodwall**

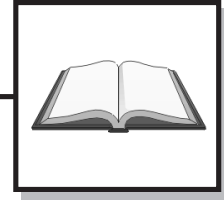
Flood barrier constructed of manmade materials, such as concrete or masonry.

**Floodway**

Portion of the regulatory floodplain that must be kept free of development so that flood elevations will not increase beyond a set limit--a maximum of 1 foot according to

## Appendix B - Glossary of Terms

---



NFIP guidelines. The floodway usually consists of the stream channel and land along its sides. Also known as a Regulatory floodway.

- Flow velocity** Speed at which water moves during a flood. Velocities usually vary across the floodplain. They are usually greatest near the channel and lowest near the edges of the floodplain.
- Footing** Enlarged base of a foundation wall or independent vertical member (such as a pier, post, or column) for a house or other structure, including a floodwall. A footing provides support by spreading the load of a structure so that the bearing capacity of the soil is not exceeded.
- Foundation** The underlying structure of a building, usually constructed of concrete, that supports the foundation walls, piers, or columns.
- Foundation walls** A support structure that connects the foundation to the main portion of the building, or superstructure.
- Freeboard** Additional amount of height incorporated into the DFE to account for uncertainties in the determination of flood elevations.
- Frequency** See "Flood frequency."
- Gate valve** Valve that permits flow in either direction when open, and prevents flow in either direction when closed. A gate valve must be operated either manually or electrically.

**Hazard mitigation**

Action taken to reduce or eliminate long-term risk to people and property from hazards such as floods, earthquakes, and fires.

**Human intervention**

Any action that a person must take to enable a flood protection measure to function as intended. This action must be taken every time flooding threatens.

**Hydrodynamic force**

Force exerted by moving water; including positive frontal pressure against the structure, drag effect along the sides, and negative pressures on the downstream side.

**Hydrostatic force**

Force exerted by water at rest, including lateral pressure on walls and uplift (buoyancy) on floors.

**Impervious soils** Soils that resist penetration by water.

**Levee** Flood barrier constructed of compacted soil.

**Local officials** Community employees who are responsible for floodplain management, zoning, permitting, building code enforcement, and building inspection.

**Lowest Adjacent Grade (LAG)**

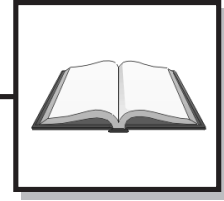
Elevation of the lowest ground surface that touches any of the exterior walls of a building.

**Lowest floor** Floor of the lowest enclosed area within the building, including the basement.

**Masonry veneer** Nonstructural, decorative, exterior layer of brick, stone, or concrete block added to the walls of a building.

## Appendix B - Glossary of Terms

---



### **Mean Sea Level (MSL)**

Datum plane; the average height of the sea for all stages of the tide, usually determined from hourly height observations over a 19-year period on an open coast or in adjacent waters having free access to the sea.

### **National Flood Insurance Program (NFIP)**

The Federal program, created by an act of Congress in 1968, that makes flood insurance available in communities that enact satisfactory floodplain management regulations.

### **National Geodetic Vertical Datum of 1929 (NGVD)**

Elevation datum plane previously used by FEMA for the determination of flood elevations.

### **North American Vertical Datum of 1988 Plane (NAVD)**

Elevation datum currently used by FEMA for the determination of flood elevations.

**100-Year Flood** The flood that has a one-percent chance of being equaled or exceeded in any given year. It is also known as the Base Flood.

**Openings** A system designed to allow flood waters to enter an enclosure, usually the interior of foundation walls, so that the rising water does not create a dangerous differential in hydrostatic pressure. This is usually achieved through small openings in the wall, such as a missing or rotated brick or concrete block, or a small pipe.

### **Passive retrofitting method**

Method that operates automatically, without human intervention. See "Active retrofitting method."





## Appendix B - Glossary of Terms

**Permeable soils** Soils that water can easily penetrate and spread through.

**Pier** Vertical support member of masonry or cast-in-place concrete that is designed and constructed to function as an independent structural element in supporting and transmitting both building loads and environmental loads to the ground.

**Piling** Vertical support member of wood, steel, or precast concrete that is driven or jetted into the ground and supported primarily by friction between the pilings and the surrounding earth. Piling often cannot act as independent support units and therefore are often braced with connections to other pilings.

**Post** Long vertical support member of wood or steel set in holes that are backfilled with compacted material. Posts often cannot act as independent support units and therefore are often braced with connections to other posts.

**Precast concrete** Concrete structures and structural members brought to the construction site in completed form.

**Rates of rise and fall**

How rapidly the elevation of the water rises and falls during a flood.

**Regulatory floodplain**

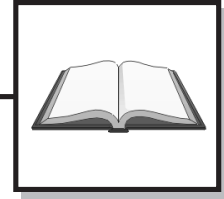
Flood hazard area within which a community regulates development, including new construction, the repair of substantially damaged buildings, and substantial improvements to existing buildings. In communities participating in the NFIP, the regulatory floodplain must include at least the area inundated by the base flood, also referred to as the SFHA. See "Floodplain."

**Regulatory floodway**

See "Floodway."

## Appendix B - Glossary of Terms

---



- Reinforcement** Inclusion of steel bars in concrete members and structures to increase their strength.
- Relocation** In retrofitting, the process of moving a house or other building to a new location outside the flood hazard area.
- Retrofitting** Making changes to an existing house or other building to protect it from flooding or other hazards.
- Riprap** Pieces of rock, broken stone, or rubble added to the surface of a fill slope, such as the side of a levee, to prevent erosion.
- Saturated soils** Soils that have absorbed, to the maximum extent possible, water from rainfall or snowmelt.
- Scour** Process by which flood waters remove soil around objects that obstruct flow, such as the foundation walls of a house.
- Sealant** In retrofitting, a waterproofing material or substance used to prevent the infiltration of flood water.
- Service equipment** In retrofitting, the utility systems, heating and cooling systems, and large appliances in a house.
- Slab-on-grade** Type of foundation in which the lowest floor of the house is formed by a concrete slab that sits directly on the ground. The slab may be supported by independent footings or integral grade beams.
- Special Flood Hazard Area (SFHA)** Portion of the floodplain subject to inundation by the base flood, designated Zone A, AE, A1 - A30, AH, AO, AR, V, VE, or V1 - V30 on a FIRM.



**Storm surge** Rise in the level of the ocean that results from the decrease in atmospheric pressure associated with hurricanes and other storms.

**Subgrade** Below the level of the ground surface.

**Substantial damage**

Damage of any origin sustained by a structure whereby the cost of restoring the structure to its before damaged condition would equal or exceed 50 percent of the market value of the structure before the damage occurred.

**Substantial improvement**

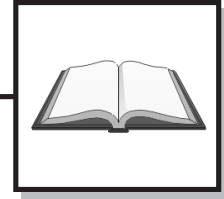
Any reconstruction, rehabilitation, addition, or other improvement of a structure, the cost of which equals or exceeds 50 percent of the market value of the structure before the “start of construction” of the improvement. This term includes structures that have incurred “substantial damage,” regardless of the actual repair work performed. The term does not, however, include either:

- 1.) Any project for improvement of a structure to correct existing violations of state or local health, sanitary, or safety code specifications that have been identified by the local code enforcement official and that are the minimum necessary to ensure safe living conditions, or
- 2.) Any alteration of a “historic structure” provided that the alteration will not preclude the structure’s continued designation as a “historic structure.”

**Sump pump** Device used to remove water from seepage or rainfall that collects in areas protected by a levee, floodwall, or dry floodproofing. In addition, a sump pump is often part of a standard house drainage system that removes water that collects below a basement slab floor.

## Appendix B - Glossary of Terms

---



**Tsunami** Great sea wave produced by an undersea earth movement or volcanic eruption.

**Veneer** See "Masonry veneer."

**V-Zone** See Coastal High Hazard Area.

**Walkout-on-grade basement**

Basement whose floor is at ground level on at least one side of a house. The term "walkout" is used because most basements of this type have an outside door at ground level. A walkout-on-grade basement is not considered a basement under the NFIP. See "Basement".

**Wet floodproofing**

Protecting a building by allowing flood waters to enter so that internal and external hydrostatic pressures are equalized. Usually, only enclosed areas used for parking, storage, or building access are wet floodproofed.

### FEMA Offices

The addresses and telephone numbers of the 10 FEMA Regional Offices are listed below. Staff members of the Regional Office for your area can give you more information about retrofitting, hazard mitigation, and the NFIP.

#### **FEMA HEADQUARTERS**

Office of the Associate Director for Mitigation  
500 C Street, SW.  
Washington, DC 20472  
(202) 646-4622

#### **REGION I - CT, ME, NH, RI, VT**

J. W. McCormack POCB, Room 442  
Boston, MA 02109-4595  
(617) 223-9561

#### **REGION II - NJ, NY, PR, VI**

26 Federal Plaza, Room 1337  
New York, NY 10278-0002  
(212) 225-7209

#### **REGION III - DE, DC, MD, PA, VA, WV**

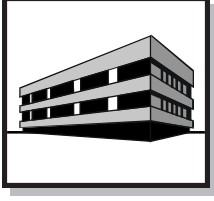
615 Chestnut Street  
6th Floor  
Philadelphia, PA 19106  
(215) 931-5608

#### **REGION IV - AL, FL, GA, KY, MS, NC, SC, TN**

Koger Center - Rutgers Building  
3003 Chamblee-Tucker Road  
Atlanta, GA 30341  
(770) 220-5200

#### **REGION V - IL, IN, MI, MN, OH, WI**

175 West Jackson Boulevard, Fourth Floor  
Chicago, IL 60604-2698  
(312) 408-5501



### **REGION VI - AR, LA, NM, OK, TX**

Federal Regional Center  
800 North Loop 288  
Denton, TX 76201-3698  
(940) 898-5399

### **REGION VII - IA, KS, MO, NE**

2323 Grand Boulevard, Suite 900  
Kansas City, MO 64108-2670  
(816) 283-7061

### **REGION VIII - CO, MT, ND, SD, UT, WY**

Denver Federal Center, Building 710  
P.O. Box 25267  
Denver, CO 80255-0267  
(303) 235-4812

### **REGION IX - AZ, CA, HI, NV**

Presidio of San Francisco, Building 105  
San Francisco, CA 94129-1250  
(415) 923-7100

### **REGION X - AK, ID, OR, WA**

Federal Regional Center  
130 228th Street, SW.  
Bothell, WA 98021-9796  
(425) 487-4604

To order copies of FIRMs, and for information about FIS reports, call the FEMA Map Service Center toll-free at 1-800-358-9616, or mail a Flood Insurance Map Order Form (available from the Service Center) to the following address:

Federal Emergency Management Agency  
Mitigation Directorate - Map Service Center  
6730 Santa Barbara Court  
Baltimore, MD 20221-5624

### NFIP State Coordinating Agencies

#### **ALABAMA**

**Alabama Emergency Management Agency**

The State House, Suite 127  
P.O. Box 301701  
Montgomery, AL 36130-1701  
(334) 353-5716

#### **ALASKA**

**Alaska Department of Community and Regional Affairs**

Municipal and Regional Assistance Division  
333 W. 4th Avenue, Suite 220  
Anchorage, AK 99501-2341  
(907) 269-4500

#### **ARIZONA**

**Arizona Department of Water Resources**

500 N. Third Street, 2nd Floor  
Phoenix, AZ 85004-3903  
(602) 417-2400

#### **ARKANSAS**

**Arkansas Soil and Water Conservation Commission**

101 E. Capitol, Suite 350  
Little Rock, AR 72201-3823  
(501) 682-3969

#### **CALIFORNIA**

**California Department of Water Resources**

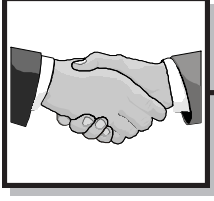
Division of Flood Management  
1416 9th Street, Room 1623  
Sacramento, CA 95814  
(916) 653-9902

#### **COLORADO**

**Colorado Water Conservation Board**

State Centennial Building, Room 721  
1313 Sherman Street  
Denver, CO 80203  
(303) 866-3441





## Appendix D - NFIP State Coordinating Agencies

---

### **CONNECTICUT**

#### **State Department of Environmental Protection**

79 Elm Street  
Hartford, CT 06106  
(860) 424-3873

### **DELAWARE**

#### **Department of Natural Resources and Environmental Control**

Division of Soil and Water Conservation  
99 Kings Highway  
P.O. Box 1401  
Dover, DE 19903  
(302) 739-4411

### **DISTRICT OF COLUMBIA**

#### **Department of Consumer and Regulatory Affairs**

614 H Street, NW., Suite 500  
Washington, DC 20001  
(202) 727-7577

### **FLORIDA**

#### **Department of Community Affairs**

William E. Sadowski Building  
2555 Shumard Oak Boulevard  
Tallahassee, Florida 32399  
(904) 413-9960

### **GEORGIA**

#### **Department of Natural Resources**

Environmental Protection Division  
7 Martin Luther King, Jr., Drive, SW.  
Atlanta, GA 30334  
(404) 656-6382

### **HAWAII**

#### **Hawaii Board of Land and Natural Resources**

P.O. Box 373  
Honolulu, HI 96809  
(808) 587-0222

## Appendix D - NFIP State Coordinating Agencies

---



### **IDAHO**

#### **Department of Water Resources**

State House  
1301 N. Orchard  
Boise, ID 83720  
(208) 327-7993

### **ILLINOIS**

#### **Illinois Department of Natural Resources**

Office of Water Resources  
524 South Second Street  
Springfield, IL 62701-1787  
(217) 782-3862

### **INDIANA**

#### **Indiana Department of Natural Resources**

402 W. Washington Street, Room W264  
Indianapolis, IN 46204-2743  
(317) 232-4178

### **IOWA**

#### **Iowa Department of Natural Resources**

Wallace State Office Building  
Des Moines, IA 50319  
(515) 281-8942

### **KANSAS**

#### **Kansas Division of Water Resources**

901 S. Kansas, 2nd Floor  
Topeka, KS 66612-1283  
(785) 296-2933

### **KENTUCKY**

#### **Kentucky Department of Natural Resources**

Division of Water  
Frankfort Office Park  
14 Reilly Road  
Frankfort, KY 40601  
(502) 564-3410



## Appendix D - NFIP State Coordinating Agencies

---

### **LOUISIANA**

#### **Louisiana Department of Transportation and Development**

Office of Public Works  
Floodplain Management Section  
P.O. Box 94245  
Baton Rouge, LA 70804-9245  
(504) 379-1432

### **MAINE**

#### **Maine State Planning Office**

38 State House Station  
184 State Street  
Augusta, ME 04333-0038  
(207) 287-8050

### **MARYLAND**

#### **Maryland Water Resources Administration**

Tawes State Office, Building E-2  
580 Taylor Avenue  
Annapolis, MD 21401  
(301) 974-3825

### **MASSACHUSETTS**

#### **Massachusetts Division of Water Resources**

Salltonstall Building, Room 1304  
100 Cambridge Street  
Boston, MA 02202  
(617) 626-1406

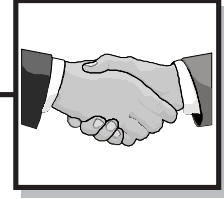
### **MICHIGAN**

#### **Michigan Land and Water Management Division**

Department of Environmental Quality  
P.O. Box 30458  
Lansing, MI 48909-7958  
(517) 335-3182

## Appendix D - NFIP State Coordinating Agencies

---



### **MINNESOTA**

#### **Flood Plains/Shoreline Management Section**

Division of Waters  
Department of Natural Resources  
500 LaFayette Road, Box 32  
St. Paul, MN 55515-4032  
(612) 296-9226

### **MISSISSIPPI**

#### **Mississippi Emergency Management Agency**

1410 Riverside Drive  
P.O. Box 4501  
Jackson, MS 39216  
(602) 960-9031

### **MISSOURI**

#### **Missouri Emergency Management Agency**

P.O. Box 116  
Jefferson City, MO 65102  
(573) 526-9141

### **MONTANA**

#### **Montana Department of Natural Resources and Conservation**

1520 East 6th Avenue  
Helena, MT 59620-2301  
(406) 444-6646

### **NEBRASKA**

#### **Nebraska Natural Resources Commission**

301 Centennial Mall South  
P.O. Box 94876  
Lincoln, NE 68509  
(402) 471-2081

### **NEVADA**

#### **Nevada Division of Water Planning**

1550 East College Parkway, Suite 142  
Carson City, NV 89706-7921  
(702) 687-3600



## Appendix D - NFIP State Coordinating Agencies

---

### **NEW HAMPSHIRE**

#### **Governor's Office of Emergency Management**

State Office Park South  
107 Pleasant Street  
Concord, NH 03301  
(603) 271-2231

### **NEW JERSEY**

#### **New Jersey Department of Environmental Protection**

Division of Coastal Resources  
CN 419  
501 East State Street  
Trenton, NJ 08619  
(609) 292-2296

### **NEW MEXICO**

#### **New Mexico Emergency Management Bureau**

P.O. Box 1628  
Santa Fe, NM 87504-1628  
(505) 827-9222

### **NEW YORK**

#### **New York Department of Environmental Conservation**

Flood Protection Bureau  
50 Wolf Road, Room 330  
Albany, NY 12233-3507  
(518) 457-3157

### **NORTH CAROLINA**

#### **North Carolina Department of Crime Control and Public Safety**

Division of Emergency Management  
116 West Jones Street  
Raleigh, NC 27603-1335  
(919) 733-3427

### **NORTH DAKOTA**

#### **North Dakota State Water Commission**

900 East Boulevard  
Bismark, ND 58505  
(701) 224-2750

## Appendix D - NFIP State Coordinating Agencies

---



### **OHIO**

#### **Ohio Department of Natural Resources**

Division of Water  
Flood Plain Management  
1939 Fountain Square, Building E-3  
Columbus, OH 43224  
(614) 265-6750

### **OKLAHOMA**

#### **Oklahoma Water Resources Board**

3800 North Classen  
Oklahoma City, OK 73118  
(405) 530-8800

### **OREGON**

#### **Department of Land Conservation Development**

1175 Court Street, NE.  
Salem, OR 97310  
(503) 378-2332

### **PENNSYLVANIA**

#### **Pennsylvania Department of Community and Economic Development**

Forum Building, Room 318  
Harrisburg, PA 17120  
(717) 787-7402

### **RHODE ISLAND**

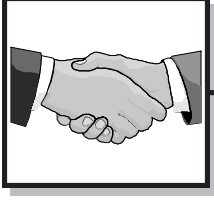
#### **Rhode Island Emergency Management Agency**

645 New London Avenue  
Cranston, RI 02920  
(401) 946-9996

### **SOUTH CAROLINA**

#### **South Carolina Department of Natural Resources**

Flood Mitigation Program  
2221 Devine Street, Suite 222  
Columbia, SC 29205  
(803) 734-9103



## Appendix D - NFIP State Coordinating Agencies

---

### **SOUTH DAKOTA**

#### **South Dakota Disaster Assistance Programs**

Emergency and Disaster Services  
500 East Capitol  
Pierre, SD 57501  
(605) 773-3231

### **TENNESSEE**

#### **Tennessee Department of Economic and Community Development**

Division of Community Development  
320 Sixth Avenue, North  
Sixth floor  
Nashville, TN 37219-5408  
(615) 741-2211

### **TEXAS**

#### **Texas Natural Resources Conservation Commission**

Capitol Station  
P.O. Box 13087  
Austin, TX 78711-3087  
(512) 239-4771

### **UTAH**

#### **Utah Department of Public Safety**

Division of Comprehensive Emergency Management  
450 N. Main  
Salt Lake City, UT 84114  
(801) 538-3400

### **VERMONT**

#### **Vermont Agency of Natural Resources**

Center Building  
103 South Main Street  
Waterbury, VT 05671-0301  
(802) 241-3759



## Appendix D - NFIP State Coordinating Agencies

---



### **VIRGINIA**

#### **Virginia Department of Conservation and Historic Resources**

Division of Soil and Water Conservation  
203 Governor Street, Suite 206  
Richmond, VA 23219  
(804) 371-6136

### **WASHINGTON**

#### **Washington Department of Ecology**

P.O. Box 47690  
Olympia, WA 98504  
(206) 459-6791

### **WEST VIRGINIA**

#### **West Virginia Office of Emergency Services**

Room EB-80  
Capitol Building  
Charleston, WV 25305  
(304) 348-5380

### **WISCONSIN**

#### **Wisconsin Department of Natural Resources**

Floodplain - Shoreland Management Section  
P.O. Box 7921  
Madison, WI 53707  
(608) 266-1926

### **WYOMING**

#### **Wyoming Emergency Management Agency**

P.O. Box 1709  
Cheyenne, WY 82003  
(307) 777-4900

### **GUAM (011) 671-477-9841**

#### **Guam Department of Public Works**

Post Office Box 2877  
Agana, Guam 96910  
(011) 671-477-7567



## Appendix D - NFIP State Coordinating Agencies

---

### **PUERTO RICO**

#### **Puerto Rico Planning Board**

P.O. Box 41119, Minillas Station  
De Diego Avenue, Stop 22  
San Juan, PR 00940-90985  
(809) 727-4444

### **VIRGIN ISLANDS**

#### **Department of Planning and Natural Resources**

3961 Estate Anna's Retreat  
Foster's Plaza  
St. Thomas, VI 00802  
(340) 774-3320 x181

### Professional Organizations

The organizations listed below can provide information about registered design professionals and licensed contractors in or near the area where you live.

**American Institute of Architects**

1735 New York Avenue, NW  
Washington, DC 20090  
(202) 626-7300

**American Society of Civil Engineers (ASCE)**

World Headquarters  
1801 Alexander Bell Drive  
Reston, VA 20191  
(703) 295-6300

**National Association of Home Builders**

15th and M Street, NW  
Washington, DC 20090  
(202) 822-0200

**Gas Appliance Manufacturer's Association**

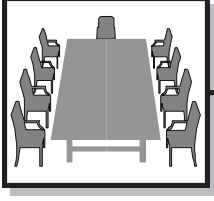
1901 North Moore Street, Suite 1100  
Arlington, VA 22209  
(703) 525-9565

**National Association of Plumbing & Heating-Cooling Contractors**

180 S. Washington Street  
P.O. Box 6808  
Falls Church, VA 22040  
(800) 533-7694

**American Society of Heating, Refrigeration  
and Air Conditioning Engineers**

1791 Tullie Circle, N.E.  
Atlanta, GA 30329  
(404) 636-8400



## Appendix E - Professional Organizations

---

### **National Electrical Manufacturers Association (NEMA)**

1300 North 17th Street

Suite 1847

Rosslyn, VA 22209