



**CONSENT CALENDAR**

**Agenda Item #s 6,7,8, & 9**

**AGENDA REPORT SUMMARY**

**Meeting Date:** November 10, 2020

**Subject:** Building Electrification and Electric Vehicle Infrastructure Reach Codes – Proposed Reach Codes for 2019 Energy Code

**Prepared by:** Environmental Commission and Staff

**Reviewed by:** Jon Biggs, Community Development Director

**Approved by:** Chris Jordan, City Manager

**Attachment(s):**

1. Ordinance No. 2020-470A
2. Ordinance No. 2020-470B
3. Ordinance No. 2020-470C
4. Ordinance No. 2020-471

**Initiated by:**

Environmental Commission

**Previous Council Consideration:**

November 19, 2019; September 22, 2020, October 27, 2020

**Fiscal Impact:**

None

**Environmental Review:**

The City Council hereby finds and determines that this Ordinance has been assessed in accordance with the California Environmental Quality Act (Cal. Pub. Res. Code, § 21000 et seq.) (“CEQA”) and the State CEQA Guidelines (14 Cal. Code Regs. § 15000 et seq.) and is categorically exempt from CEQA under CEQA Guidelines, § 15061(b)(3), which exempts from CEQA any project where it can be seen with certainty that there is no possibility that the activity in question may have a significant effect on the environment. Adoption of the proposed Ordinance would not be an activity with potential to cause significant adverse effect on the environment because the changes made to the California Energy Code are to provide more protection to the environment, and therefore is exempt from CEQA. It is also exempt from CEQA pursuant to CEQA Guidelines, § 15308 which exempts actions taken by regulatory agencies for the enhancement and protection of the environment. As such, the Ordinance is categorically exempt from CEQA.

---

**Reviewed By:**

City Manager

*CJ*

City Attorney

*JH*

Finance Director

*SE*

---



**Subject:** Building Electrification and Electric Vehicle Infrastructure Reach Codes – Proposed Reach Codes for 2019 Energy Code and the 2019 Green Building Standards Code

---

**Policy Question(s) for Council Consideration:**

- Does the Council wish to adopt Building Electrification and Electric Vehicle Infrastructure Codes containing requirements that limits power sources to principally electric appliances, fixtures, and equipment?

**Summary:**

Every three years, the State of California adopts new building standards that are organized in Title 24 of the California Code of Regulations, referred to as the California Building Standards Code. The City has adopted the 2019 building codes, which became effective statewide on January 1, 2020. Cities and counties can adopt amendments to building codes that have requirements that exceed minimum building code requirements. Reach codes provide requirements that exceed the standards for the energy and green building standards codes and require the installation of electric vehicle infrastructure in new construction. The energy reach codes must be approved by the California Energy Commission (“CEC”) before they can be enforced by a local government. To obtain CEC approval, a local government must find that the energy reach code is cost-effective, and the CEC must find that the reach code will require the diminution of energy consumption levels permitted by the state code.

**Recommendation:**

The Environmental Commission recommends the City Council adopt building electrification and electric vehicle reach codes, which amend the 2019 California Building Standards Code that was adopted, and became effective on January 1, 2020; to help reduce carbon emissions associated with new construction, reduce costs in new construction, improve indoor air quality and safety of our building stock, support affordable housing, and increase adoption of electric vehicles.

**Purpose**

The ordinance will put into effect requirements that mandate newly constructed buildings be all-electric with exceptions, and the installation of electric vehicle charging infrastructure for new construction.

**Background**

On November 19, 2019, the Environmental Commission presented the City Council with a Mixed-Fuel Reach Code Ordinance. During the first reading of the Ordinance, Council directed the Environmental Commission to pursue an All-Electric Reach Code Ordinance and to conduct community outreach.

On September 22, 2020, a public hearing of this ordinance was held, at which time the Environmental Commission and staff provided an overview of the reach code measures proposed in the ordinance, described the reach code development process, and explained findings that the energy reach code is cost-effective and will require the diminution of energy consumption levels permitted by the state



**Subject:** Building Electrification and Electric Vehicle Infrastructure Reach Codes – Proposed Reach Codes for 2019 Energy Code and the 2019 Green Building Standards Code

---

Energy Code. Council by motion directed staff to make modifications to the Building and Electrification Reach Code ordinance building type/use and reintroduce the ordinances.

On October 27, 2020, Council introduced the Building Electrification Reach Codes ordinance and waived its reading. No changes have been done since the introduction of the ordinance and we recommend its adoption.

### **Discussion/Analysis**

On October 27, 2020, by motion Council directed staff to modify the Electric Vehicle Infrastructure Reach Code ordinances, introduced the ordinances, as amended, and waived their reading. Changes have been made and incorporated since the introduction of the ordinance per Council’s direction and we recommend their adoption. Substantive changes or modifications to the code may not be made between the introduction of an ordinance and its adoption. Any substantive change to the ordinance would require its re-introduction.

### **Options**

- 1) Adopt Ordinance No. 2020-470A, Ordinance No. 2020-470B, and Ordinance No. 2020-470C, in the recommended sequence, amending chapter 12.22 Energy Code of Title 12 of the Los Altos Municipal code relating to amendments to the 2019 California Energy Code for All-Electric Buildings and adopt Ordinance No. 2020-471 amending chapter 12.26 Green Building Standards Code for Electric Vehicle Infrastructure.

**Advantages:** Reduce carbon emissions associated with new construction, improve indoor air quality and building safety, support affordable housing, and increase adoption of electric vehicles.

**Disadvantages:** Fail to follow PCE and SVCE member agencies that have already adopted reach codes to reduce carbon emissions associated with new construction, Fail to adopt a policy that advances the City’s sustainability and GHG emission reductions in line with Council Strategic Goals and Objectives 7. Do not take advantage of an opportunity to improve new building indoor air quality and safety, support affordable housing, and increase adoption of electric vehicles.

- 2) Do not adopt the Ordinance(s) and provide staff direction on changes to the Ordinance(s).

**Advantages:** Modifications can be made to the Ordinance(s) as necessary before being reintroduced



**Subject:** Building Electrification and Electric Vehicle Infrastructure Reach Codes – Proposed Reach Codes for 2019 Energy Code and the 2019 Green Building Standards Code

---

**Disadvantages:** Implementation will be delayed and allow for continued environmental harm and action to further environmental goals will be delayed

**Recommendation**

The staff recommends Option 1.

**ORDINANCE NO. 2020-470A**

**AN ORDINANCE OF THE CITY COUNCIL OF THE CITY OF LOS ALTOS  
AMENDING CHAPTER 12.22 ENERGY CODE OF TITLE 12 OF THE LOS ALTOS  
MUNICIPAL CODE RELATING TO AMENDMENTS TO THE 2019 CALIFORNIA  
ENERGY CODE FOR ALL-ELECTRIC SINGLE-FAMILY BUILDINGS, MULTI-  
FAMILY BUILDINGS HAVING FROM TWO TO NINE RESIDENTIAL UNITS, AND  
DETACHED ACCESSORY DWELLING UNIT BUILDINGS**

**WHEREAS**, the California Building Standards Commission adopted and published an updated Title 24 of the California Code of Regulations, known as the 2019 California Building Standards Code, that became effective statewide on January 1, 2020; and

**WHEREAS**, California Health and Safety Code Sections 17958.5, 17958.7 and 18941.5 authorize cities to adopt the California Building Standards Code with modifications determined to be reasonably necessary because of local climatic, geological, or topographical conditions; and

**WHEREAS**, the City of Los Altos has adopted the 2019 California Building Standards Code with local amendments; and

**WHEREAS**, the City has adopted the 2019 California Energy Code in the 2019 California Building Standards Code, Part 6 of Title 24 of the California Code of Regulations, which implements minimum energy efficiency standards in buildings through mandatory requirements, prescriptive standards, and performances standards; and

**WHEREAS**, Public Resources Code Section 25402.1(h)(2) and Section 10-106 Locally Adopted Energy Standards of the California Administrative Code, Title 24 of the California Code of Regulations, Part I, establish a process which allows local adoption of energy standards that are more stringent than the statewide standards, provided that such local standards are cost effective and the California Energy Commission finds that the standards will require buildings to be designed to consume no more energy than permitted by the California Energy Code; and

**WHEREAS**, the City Council wishes to amend portions of the California Energy Code and affirms that such local modifications are cost effective and will result in designs that consume no more energy than that permitted under the 2019 California Energy Code; and

**WHEREAS**, the City's Climate Action Plan sets forth the goal to support initiatives that promote environmental sustainability and reduce the City's greenhouse gas emissions.

**NOW THEREFORE**, the City Council of the City of Los Altos does hereby ordain as follows:

**SECTION 1. AMENDMENT OF CODE.** Chapter 12.22 of Title 12 of the Los Altos Municipal Code is hereby amended in its entirety to read as follows:

**Chapter 12.22 ENERGY CODE**

### **Section 12.22.010 Adoption of the California Energy Code.**

There is hereby adopted by reference as if fully set forth herein, the 2019 California Energy Code, contained in the California Code of Regulations, Title 24, Part 6, published by the International Code Council, and each and all of its regulations and provisions. One copy is on file for use and examination by the public in the office of the Building Official.

### **Section 12.22.020 Amendments for All-Electric Buildings.**

- A. Amend Section 100.1(b) of the Energy Code by adding the following definitions to read as follows:

**ALL-ELECTRIC BUILDING** is a building that has no natural gas or propane plumbing installed within the building.

**NEWLY CONSTRUCTED BUILDING (Applicable to Chapter 12.22 Energy Code Section 12.22.020 Amendments)** is a building that has never been used or occupied for any purpose and supported by 1) a new structural foundation, 2) an existing, structural foundation where a building has been demolished and removed to floor or below, or 3) a combination of 1) and 2).

**PUBLIC BUILDING** is a building used by the public for any purpose, such as assembly, education, entertainment, or worship.

**SCIENTIFIC LABORATORY BUILDING** is a building or area where research, experiments, and measurement in medical, life, and physical sciences are performed and/or stored requiring examination of fine details. The building may include workbenches, countertops, scientific instruments, and supporting offices.

Subchapter 1 Section 100.0(e)2. A. is deleted and replaced to read as follows, based on express finding of necessity set forth of this Ordinance.

- B. Amend Section 100.0(e)2. A. of the Energy Code to read as follows:

#### **2. Newly constructed buildings.**

- A. Sections 110.0 through 110.12 apply to all newly constructed buildings within the scope of Section 100.0(a). In addition, newly constructed buildings shall meet the requirements of Subsections B, C, D or E, as applicable and shall be an all-electric building as defined in Section 100.1(b).

Exception 1: Residential Single-Family Dwellings, Detached ADUs (Accessory Dwelling Units), Multifamily Dwellings with two to nine units may install non-electric (natural gas-fueled) cooking and fireplace appliances if the applicant complies with the prewiring provisions, Subsection 12.22.020 B.3.

#### **3. Wiring to accommodate future electric appliances or equipment.**

(a) If a non-electric appliance or piece of equipment is allowed to be installed, the appliance or equipment location must also be electrically pre-wired for future electric appliance or equipment installation, including:

- i. A dedicated circuit, phased appropriately, with a minimum amperage requirement for a comparable electric appliance with an electrical receptacle or junction box that is connected to the electric panel with conductors of adequate capacity, extending to within 3 feet of the appliance and accessible with no obstructions. Appropriately sized conduit may be installed in lieu of conductors; and
- ii. Both ends of the unused conductor or conduit shall be labeled with the words “For Future Electric appliance or equipment” and be electrically isolated; and
- iii. A reserved circuit breaker space shall be installed in the electrical panel adjacent to the circuit breaker for the branch circuit and labeled for each circuit, an example is as follows (i.e. “For Future Electric Range;”); and,
- iv. All electrical components, including conductors, receptacles, junction boxes, or blank covers, related to this section shall be installed in accordance with the California Electrical Code.

## **SECTION 2.**

The following findings support that the above amendments and modifications are reasonably necessary because of local climatic, geological or topographical conditions:

The City of Los Altos is located in Climate Zone 4 as established in the 2019 California Energy Code. Climate Zone 4 includes Santa Clara County, San Benito County, portions of Monterey County and San Luis Obispo. The City experiences an average of 19 inches of precipitation per year. In Los Altos, January is the rainiest month of the year while July is the driest month of the year. Temperatures average about 80 degrees Fahrenheit in the summer and about 40 degrees Fahrenheit in the winter. These climatic conditions along with the effects of climate change caused by Green House Gas (GHG) emissions generated from burning natural gas to heat buildings and emissions from Vehicle Miles Traveled results in an overall increase in global average temperature. Higher global temperatures are contributing to rising sea levels, record heat waves, droughts, wildfires and floods.

The above local amendments to the 2019 California Energy Code are necessary to combat the ever-increasing harmful effects of global climate change. Implementation of the proposed code amendments will achieve decarbonization and provide an accelerated path to reduce GHG emissions. The proposed Ordinance containing these amendments would ensure that new buildings use cleaner sources of energy which helps meet the goal of cutting carbon emissions in half by 2030.

All-electric building design benefits the health, welfare, and resiliency of Los Altos and its residents.

## **SECTION 3. CONSTITUTIONALITY.**

If any section, subsection, sentence, clause or phrase of this code is for any reason held to be invalid or unconstitutional, such decision shall not affect the validity of the remaining portions of this code.

#### **SECTION 4. CEQA.**

The City Council hereby finds and determines that this Ordinance has been assessed in accordance with the California Environmental Quality Act (Cal. Pub. Res. Code, § 21000 et seq.) (“CEQA”) and the State CEQA Guidelines (14 Cal. Code Regs. § 15000 et seq.) and is categorically exempt from CEQA under CEQA Guidelines, § 15061(b)(3), which exempts from CEQA any project where it can be seen with certainty that there is no possibility that the activity in question may have a significant effect on the environment. Adoption of the proposed Ordinance would not be an activity with potential to cause significant adverse effect on the environment because the changes made to the California Energy Code within are enacted to provide more protection to the environment, and therefore is exempt from CEQA. It is also exempt from CEQA pursuant to CEQA Guidelines, § 15308 which exempts actions taken by regulatory agencies for the enhancement and protection of the environment. As such, the Ordinance is categorically exempt from CEQA.

#### **SECTION 5. PUBLICATION.**

This Ordinance shall be published as provided in Government Code section 36933.

#### **SECTION 6. EFFECTIVE DATE.**

This Ordinance shall be effective upon the commencement of the thirty-first (31st) day following the adoption date. The City Council’s findings of cost-effectiveness and energy savings will be filed with the California Energy Commission pursuant to Title 24 Chapter 10-106 before this ordinance takes effect.

The foregoing Ordinance was duly and properly introduced at a regular meeting of the City Council of the City of Los Altos held on \_\_\_\_\_, 2020 and was thereafter, at a regular meeting held on \_\_\_\_\_, 2020 passed and adopted by the following vote:

AYES:

NOES:

ABSENT:

ABSTAIN:

---

Janis C. Pepper, Mayor

ATTEST

---

Andrea Chelemengos MMC, City Clerk



**ORDINANCE NO. 2020-470B**

**AN ORDINANCE OF THE CITY COUNCIL OF THE CITY OF LOS ALTOS  
AMENDING CHAPTER 12.22 ENERGY CODE OF TITLE 12 OF THE LOS ALTOS  
MUNICIPAL CODE RELATING TO AMENDMENTS TO THE 2019 CALIFORNIA  
ENERGY CODE FOR ALL-ELECTRIC MULTI-FAMILY RESIDENTIAL  
DEVELOPMENTS HAVING TEN (10) OR MORE UNITS**

**WHEREAS**, the California Building Standards Commission adopted and published an updated Title 24 of the California Code of Regulations, known as the 2019 California Building Standards Code, that became effective statewide on January 1, 2020; and

**WHEREAS**, California Health and Safety Code Sections 17958.5, 17958.7 and 18941.5 authorize cities to adopt the California Building Standards Code with modifications determined to be reasonably necessary because of local climatic, geological, or topographical conditions; and

**WHEREAS**, the City of Los Altos has adopted the 2019 California Building Standards Code with local amendments; and

**WHEREAS**, the City has adopted the 2019 California Energy Code in the 2019 California Building Standards Code, Part 6 of Title 24 of the California Code of Regulations, which implements minimum energy efficiency standards in buildings through mandatory requirements, prescriptive standards, and performances standards; and

**WHEREAS**, Public Resources Code Section 25402.1(h)(2) and Section 10-106 Locally Adopted Energy Standards of the California Administrative Code, Title 24 of the California Code of Regulations, Part I, establish a process which allows local adoption of energy standards that are more stringent than the statewide standards, provided that such local standards are cost effective and the California Energy Commission finds that the standards will require buildings to be designed to consume no more energy than permitted by the California Energy Code; and

**WHEREAS**, the City Council wishes to amend portions of the California Energy Code and affirms that such local modifications are cost effective and will result in designs that consume no more energy than that permitted under the 2019 California Energy Code; and

**WHEREAS**, the City's Climate Action Plan sets forth the goal to support initiatives that promote environmental sustainability and reduce the City's greenhouse gas emissions.

**NOW THEREFORE**, the City Council of the City of Los Altos does hereby ordain as follows:

**SECTION 1. AMENDMENT OF CODE.** Chapter 12.22 of Title 12 of the Los Altos Municipal Code is hereby amended in its entirety to read as follows:

**Chapter 12.22 ENERGY CODE**

### **Section 12.22.010 Adoption of the California Energy Code.**

There is hereby adopted by reference as if fully set forth herein, the 2019 California Energy Code, contained in the California Code of Regulations, Title 24, Part 6, published by the International Code Council, and each and all of its regulations and provisions. One copy is on file for use and examination by the public in the office of the Building Official.

### **Section 12.22.020 Amendments for All-Electric Buildings.**

A. Amend Section 100.0(e)2. A. of the Energy Code to include the underlined language as follows:

#### **2. Newly constructed buildings.**

A. Sections 110.0 through 110.12 apply to all newly constructed buildings within the scope of Section 100.0(a). In addition, newly constructed buildings shall meet the requirements of Subsections B, C, D or E, as applicable and shall be an all-electric building as defined in Section 100.1(b).

Exception 1: Residential Single-Family Dwellings, Detached ADUs (Accessory Dwelling Units), Multifamily Dwellings with two to nine units may install non-electric (natural gas-fueled) cooking and fireplace appliances if the applicant complies with the prewiring provisions, Subsection 12.22.020 B.3.

## **SECTION 2.**

The following findings support that the above amendments and modifications are reasonably necessary because of local climatic, geological or topographical conditions:

The City of Los Altos is located in Climate Zone 4 as established in the 2019 California Energy Code. Climate Zone 4 includes Santa Clara County, San Benito County, portions of Monterey County and San Luis Obispo. The City experiences an average of 19 inches of precipitation per year. In Los Altos, January is the rainiest month of the year while July is the driest month of the year. Temperatures average about 80 degrees Fahrenheit in the summer and about 40 degrees Fahrenheit in the winter. These climatic conditions along with the effects of climate change caused by Green House Gas (GHG) emissions generated from burning natural gas to heat buildings and emissions from Vehicle Miles Traveled results in an overall increase in global average temperature. Higher global temperatures are contributing to rising sea levels, record heat waves, droughts, wildfires and floods.

The above local amendments to the 2019 California Energy Code are necessary to combat the ever-increasing harmful effects of global climate change. Implementation of the proposed code amendments will achieve decarbonization and provide an accelerated path to reduce GHG emissions. The proposed Ordinance containing these amendments would ensure that new buildings use cleaner sources of energy which helps meet the goal of cutting carbon emissions in half by 2030.

All-electric building design benefits the health, welfare, and resiliency of Los Altos and its residents.

**SECTION 3. CONSTITUTIONALITY.**

If any section, subsection, sentence, clause or phrase of this code is for any reason held to be invalid or unconstitutional, such decision shall not affect the validity of the remaining portions of this code.

**SECTION 4. CEQA.**

The City Council hereby finds and determines that this Ordinance has been assessed in accordance with the California Environmental Quality Act (Cal. Pub. Res. Code, § 21000 et seq.) (“CEQA”) and the State CEQA Guidelines (14 Cal. Code Regs. § 15000 et seq.) and is categorically exempt from CEQA under CEQA Guidelines, § 15061(b)(3), which exempts from CEQA any project where it can be seen with certainty that there is no possibility that the activity in question may have a significant effect on the environment. Adoption of the proposed Ordinance would not be an activity with potential to cause significant adverse effect on the environment because the changes made to the California Energy Code within are enacted to provide more protection to the environment, and therefore is exempt from CEQA. It is also exempt from CEQA pursuant to CEQA Guidelines, § 15308 which exempts actions taken by regulatory agencies for the enhancement and protection of the environment. As such, the Ordinance is categorically exempt from CEQA.

**SECTION 5. PUBLICATION.**

This Ordinance shall be published as provided in Government Code section 36933.

**SECTION 6. EFFECTIVE DATE.**

This Ordinance shall be effective upon the commencement of the thirty-first (31st) day following the adoption date. The City Council’s findings of cost-effectiveness and energy savings will be filed with the California Energy Commission pursuant to Title 24 Chapter 10-106 before this ordinance takes effect.

The foregoing Ordinance was duly and properly introduced at a regular meeting of the City Council of the City of Los Altos held on \_\_\_\_\_, 2020 and was thereafter, at a regular meeting held on \_\_\_\_\_, 2020 passed and adopted by the following vote:

- AYES:
- NOES:
- ABSENT:
- ABSTAIN:

---

Janis C. Pepper, Mayor

ATTEST

---

Andrea Chelemengos MMC, City Clerk

**ORDINANCE NO. 2020-470C**

**AN ORDINANCE OF THE CITY COUNCIL OF THE CITY OF LOS ALTOS  
AMENDING CHAPTER 12.22 ENERGY CODE OF TITLE 12 OF THE LOS ALTOS  
MUNICIPAL CODE RELATING TO AMENDMENTS TO THE 2019 CALIFORNIA  
ENERGY CODE FOR ALL-ELECTRIC NON-RESIDENTIAL BUILDINGS,  
SCIENTIFIC LABORATORY BUILDINGS, AND PUBLIC BUILDINGS**

**WHEREAS**, the California Building Standards Commission adopted and published an updated Title 24 of the California Code of Regulations, known as the 2019 California Building Standards Code, that became effective statewide on January 1, 2020; and

**WHEREAS**, California Health and Safety Code Sections 17958.5, 17958.7 and 18941.5 authorize cities to adopt the California Building Standards Code with modifications determined to be reasonably necessary because of local climatic, geological, or topographical conditions; and

**WHEREAS**, the City of Los Altos has adopted the 2019 California Building Standards Code with local amendments; and

**WHEREAS**, the City has adopted the 2019 California Energy Code in the 2019 California Building Standards Code, Part 6 of Title 24 of the California Code of Regulations, which implements minimum energy efficiency standards in buildings through mandatory requirements, prescriptive standards, and performances standards; and

**WHEREAS**, Public Resources Code Section 25402.1(h)(2) and Section 10-106 Locally Adopted Energy Standards of the California Administrative Code, Title 24 of the California Code of Regulations, Part I, establish a process which allows local adoption of energy standards that are more stringent than the statewide standards, provided that such local standards are cost effective and the California Energy Commission finds that the standards will require buildings to be designed to consume no more energy than permitted by the California Energy Code; and

**WHEREAS**, the City Council wishes to amend portions of the California Energy Code and affirms that such local modifications are cost effective and will result in designs that consume no more energy than that permitted under the 2019 California Energy Code; and

**WHEREAS**, the City's Climate Action Plan sets forth the goal to support initiatives that promote environmental sustainability and reduce the City's greenhouse gas emissions.

**NOW THEREFORE**, the City Council of the City of Los Altos does hereby ordain as follows:

**SECTION 1. AMENDMENT OF CODE.** Chapter 12.22 of Title 12 of the Los Altos Municipal Code is hereby amended in its entirety to read as follows:

**Chapter 12.22 ENERGY CODE**

**Section 12.22.010 Adoption of the California Energy Code.**

There is hereby adopted by reference as if fully set forth herein, the 2019 California Energy Code, contained in the California Code of Regulations, Title 24, Part 6, published by the International Code Council, and each and all of its regulations and provisions. One copy is on file for use and examination by the public in the office of the Building Official.

A. Amend Section 100.0(e) 2. A. of the Energy Code is amended to include the underlined language as follows:

**2. Newly constructed buildings.**

A. Sections 110.0 through 110.12 apply to all newly constructed buildings within the scope of Section 100.0(a). In addition, newly constructed buildings shall meet the requirements of Subsections B, C, D or E, as applicable and shall be an all-electric building as defined in Section 100.1(b).

Exception 1: Residential Single-Family Dwellings, Detached ADUs (Accessory Dwelling Units), Multifamily Dwellings with two to nine units may install non-electric (natural gas-fueled) cooking and fireplace appliances if the applicant complies with the prewiring provisions, Subsection 12.22.020 B.3.

Exception 2: Non-residential Buildings containing for-profit restaurant open to the public may install gas-fueled cooking appliances. The applicant shall comply with the pre-wiring provision of Subsection 12.22.020 B. 3.

Exception 3: Non-residential buildings, Scientific Laboratory Buildings and Public Buildings may apply to the Building Division of the Los Altos Community Development Department for an exception to install a non-electric fueled appliance or piece of equipment. The Building Division of the Los Altos Community Development Department shall grant an exception if they find the following conditions are met:

- i. The applicant shows that there is a public or business-related need that cannot be reasonably met with an electric fueled appliance or piece of equipment.
- ii. The applicant complies with the pre-wiring provisions to the non-electric appliance or piece of equipment noted at Subsection 12.22.020 B. 3.

The decision of the Building Division of the Los Altos Community Development Department shall be final unless the applicant appeals the decision to the City Manager or his or her designee within 15 days of the date of the decision. The City Manager's or his or her designee's decision on the appeal shall be final.

**SECTION 2.**

The following findings support that the above amendments and modifications are reasonably necessary because of local climatic, geological or topographical conditions:

The City of Los Altos is located in Climate Zone 4 as established in the 2019 California Energy Code. Climate Zone 4 includes Santa Clara County, San Benito County, portions of Monterey County and San Luis Obispo. The City experiences an average of 19 inches of precipitation per year. In Los Altos, January is the rainiest month of the year while July is the driest month of the year. Temperatures average about 80 degrees Fahrenheit in the summer and about 40 degrees Fahrenheit in the winter. These climatic conditions along with the effects of climate change caused by Green House Gas (GHG) emissions generated from burning natural gas to heat buildings and emissions from Vehicle Miles Traveled results in an overall increase in global average temperature. Higher global temperatures are contributing to rising sea levels, record heat waves, droughts, wildfires and floods.

The above local amendments to the 2019 California Energy Code are necessary to combat the ever-increasing harmful effects of global climate change. Implementation of the proposed code amendments will achieve decarbonization and provide an accelerated path to reduce GHG emissions. The proposed Ordinance containing these amendments would ensure that new buildings use cleaner sources of energy which helps meet the goal of cutting carbon emissions in half by 2030.

All-electric building design benefits the health, welfare, and resiliency of Los Altos and its residents.

### **SECTION 3. CONSTITUTIONALITY.**

If any section, subsection, sentence, clause or phrase of this code is for any reason held to be invalid or unconstitutional, such decision shall not affect the validity of the remaining portions of this code.

### **SECTION 4. CEQA.**

The City Council hereby finds and determines that this Ordinance has been assessed in accordance with the California Environmental Quality Act (Cal. Pub. Res. Code, § 21000 et seq.) (“CEQA”) and the State CEQA Guidelines (14 Cal. Code Regs. § 15000 et seq.) and is categorically exempt from CEQA under CEQA Guidelines, § 15061(b)(3), which exempts from CEQA any project where it can be seen with certainty that there is no possibility that the activity in question may have a significant effect on the environment. Adoption of the proposed Ordinance would not be an activity with potential to cause significant adverse effect on the environment because the changes made to the California Energy Code within are enacted to provide more protection to the environment, and therefore is exempt from CEQA. It is also exempt from CEQA pursuant to CEQA Guidelines, § 15308 which exempts actions taken by regulatory agencies for the enhancement and protection of the environment. As such, the Ordinance is categorically exempt from CEQA.

### **SECTION 5. PUBLICATION.**

This Ordinance shall be published as provided in Government Code section 36933.

**SECTION 6. EFFECTIVE DATE.**

This Ordinance shall be effective upon the commencement of the thirty-first (31st) day following the adoption date. The City Council's findings of cost-effectiveness and energy savings will be filed with the California Energy Commission pursuant to Title 24 Chapter 10-106 before this ordinance takes effect.

The foregoing Ordinance was duly and properly introduced at a regular meeting of the City Council of the City of Los Altos held on \_\_\_\_\_, 2020 and was thereafter, at a regular meeting held on \_\_\_\_\_, 2020 passed and adopted by the following vote:

AYES:  
NOES:  
ABSENT:  
ABSTAIN:

---

Janis C. Pepper, Mayor

ATTEST

---

Andrea Chelemengos MMC, City Clerk



**ORDINANCE NO. 2020-471**  
**AN ORDINANCE OF THE CITY COUNCIL OF THE CITY OF LOS ALTOS**  
**AMENDING CHAPTER 12.26 GREEN BUILDING STANDARDS CODE OF TITLE 12**  
**OF THE LOS ALTOS MUNICIPAL CODE RELATING TO AMENDMENTS TO THE**  
**2019 CALIFORNIA GREEN BUILDING STANDARDS CODE FOR ELECTRIC**  
**VEHICLE (EV) INFRASTRUCTURE**

**WHEREAS**, the City of Los Altos has seen significant sales of both electric vehicles (EV) and plug-in hybrid electric vehicles (“PHEV”); and

**WHEREAS**, the interest in EVs has grown alongside greater EV model availability, increased vehicle range, and expanded EV charging infrastructure in the region; and

**WHEREAS**, EV charging infrastructure available at locations they frequent, including one-and two-family dwellings, multi-family residences, and commercial properties is important for continued adoption of EVs; and

**WHEREAS**, the installation of the electric vehicle supply equipment (EVSE) is made cost effective when the infrastructure is installed during the initial construction phase as opposed to retrofitting existing buildings to accommodate the new electrical equipment; and

**WHEREAS**, the City of Los Altos supports this nascent industry for plug-in electric vehicles and its efforts in constructing EV charging infrastructure as this further supports the City’s sustainability goals; and

**WHEREAS**, the California Building Standards Commission adopted and published an updated Title 24 of the California Code of Regulations, known as the 2019 California Building Standards Code, that became effective statewide on January 1, 2020; and

**WHEREAS**, California Health and Safety Code Sections 17958.5, 17958.7 and 18941.5 authorize cities to adopt the California Building Standards Code with modifications determined to be reasonably necessary because of local climatic, geological or topographical conditions; and

**WHEREAS**, the City of Los Altos has adopted the 2019 California Building Standards Code with local amendments; and

**WHEREAS**, the City has adopted the 2019 California Green Building Standards Code in the 2019 California Building Standards Code, Title 24, Part 11, which enhances the design and construction of buildings through the use of building concepts having a reduced negative impact or positive environmental impact and encouraging sustainable construction practices; and

**WHEREAS**, the City Council wishes to amend portions of the California Green Building Standards Code and affirms the modifications are determined to be reasonably necessary because of local climatic, geological or topographical conditions, ensure that new buildings can charge a greater number of electric vehicles beyond state code requirements and reduce greenhouse gas emissions.

**NOW THEREFORE**, the City Council of the City of Los Altos does hereby ordain as follows:

**SECTION 1. AMENDMENT OF CODE.** Chapter 12.26 of Title 12 of the Los Altos Municipal Code is hereby amended in its entirety to read as follows:

**Chapter 12.26 CALIFORNIA GREEN BUILDING STANDARDS CODE**

**Section 12.26.010 Adoption of the California Green Building Standards Code**

**Section 12.26.020 Amendments, Additions or Deletions**

**Section 12.26.030 Definitions**

**Section 12.26.010 Adoption of the California Green Building Standards Code**

There is hereby adopted by reference as if fully set forth herein, the 2019 California Green Building Standards Code, contained in the California Code of Regulations, Title 24, Part 11, published by the International Code Council, and each and all of its regulations and provisions. One copy is on file for use and examination by the public in the office of the Building Official.

**Section 12.26.020 Amendments, Additions or Deletions**

The 2019 California Green Building Standards Code referred to in Section 12.26.010 is adopted, together with Chapters 1 Administration, 4 Residential Mandatory Measures, and 5 Nonresidential Mandatory Measures, of the 2019 California Green Building Standards Code, with the following amendments as follows:

Chapter 1 Section 102.4 Scope and Mandatory Compliance is hereby added to read as follows.

**Section 102.4 Scope and Mandatory Compliance**

- A. This code contains both mandatory and voluntary green building measures. Mandatory and voluntary measures are identified in the appropriate chapters contained in this code. Compliance measures and methods shall be by one of the following measures approved by the Building Official.

The means by which compliance measures are achieved shall be mandatory measures with appendix sections voluntarily applied, building division mandatory check list, whole house Build it Green GreenPoint check list, LEED, other recognized point systems, Title 24 Part 6 Energy Efficiency Standards, or equivalent approved methods. Green Building Compliance measures in addition to checklists shall be incorporated into the project drawings approved by the Building

Official prior to building permit submittal.

Prior to issuance of a building permit, the owner or responsible Registered Design Professional acting as the owner's agent shall employ and/or retain a Qualified Green Building Professional to the satisfaction of the Building Official, and prior to final inspection shall submit verification that the project is in compliance with this ordinance.

Chapter 4 Section 4.106.4 Electric vehicle (EV) charging for new construction thru 4.106.4.2.5 are deleted and replaced to read as follows, based upon express findings set forth in this Ordinance

**Section 4.106.4, 4.106.4.1 and 4.106.2 are amended to read as follows:**

**4.106.4 Electric vehicle (EV) charging for new construction.**

New construction shall comply with Sections 4.106.4.1, 4.106.4.2, or 4.106.4.3 to facilitate future installation and use of EV chargers. Electric vehicle supply equipment (EVSE) shall be installed in accordance with the *California Electrical Code, Article 625*.

Exceptions:

1. Where there is no commercial power supply.
2. If no additional parking facilities are provided, then Accessory Dwelling Units (ADU) and Junior Accessory Dwelling Units (JADU).

**4.106.4.1 New one- and two-family dwellings and townhouses with attached or detached private garages.**

For each dwelling unit, install at least one Level 2 EV Ready Space in the garage. If multiple (two or more) garage parking spaces are provided for a dwelling unit, install at least two Level 2 EV Ready Spaces.

**4.106.4.1.1 Identification.**

The raceway termination location shall be permanently and visibly marked as "Level 2 EV-Ready".

**4.106.4.2 New multifamily dwellings.**

The following requirements apply to all new multifamily dwellings:

1. For multifamily buildings with less than or equal to 20 dwelling units, install at least one Level 2 EV Ready Space for each dwelling unit.
2. When more than 20 multifamily dwelling units are constructed on a building site
  - a. 25% of the dwelling units with parking space(s) shall be provided with at least one Level 2 EV Ready Space. Calculations for the required minimum number of Level 2 EV Ready spaces shall be rounded up to the nearest whole number and not less than 21 spaces.

- b. In addition, each remaining dwelling unit with parking space(s) shall be provided with at least one Level 1 EV Ready Space.

Exception: For all multifamily Affordable Housing, 10% of dwelling units with parking space(s) shall be provided with at least one Level 2 EV Ready Space. Calculations for the required minimum number of Level 2 EV Ready spaces shall be rounded up to the nearest whole number. The remaining dwelling units with parking space(s) shall each be provided with at least one Level 1 EV Ready Space.

Notes:

1. ALMS may be installed to decrease electrical service and transformer costs associated with EV Charging Equipment subject to review of the authority having jurisdiction.
2. Installation of Level 2 EV Ready Spaces above the minimum number required level may offset the minimum number Level 1 EV Ready Spaces required on a 1:1 basis.
3. The requirements apply to multifamily buildings with parking spaces including: a) assigned or leased to individual dwelling units, and b) unassigned residential parking.
4. Local jurisdictions may consider allowing exceptions through their local process, on a case by case basis, if a building permit applicant provides documentation detailing that the increased cost of utility service or on-site transformer capacity would exceed an average of \$4,500 among parking spaces with Level 2 EV Ready Spaces and Level 1 EV Ready Spaces. If costs are found to exceed this level, the applicant shall provide EV infrastructure up to a level that would not exceed this cost for utility service or on-site transformer capacity.
5. In order to adhere to accessibility requirements in accordance with California Building Code Chapters 11A and/or 11B, it is recommended that all accessible parking spaces for covered newly constructed multifamily dwellings are provided with at least a Level 1 or Level 2 EV Ready Spaces.

#### **4.106.4.2.1.1 Electric vehicle charging stations (EVCS).**

When EV chargers are installed, EV spaces required by Section 4.106.4.2.2, Item 3, shall comply with at least one of the following options:

1. The EV space shall be located adjacent to an accessible parking space meeting the requirements of the California Building Code, Chapter 11A, to allow use of the EV charger from the accessible parking space.
2. The EV space shall be located on an accessible route, as defined in the California Building Code, Chapter 2, to the building.

Exception: Electric vehicle charging stations designed and constructed in compliance with the California Building Code, Chapter 11B, are not required to comply with Section 4.106.4.2.1.1 and Section 4.106.4.2.2, Item 3.

Note: Electric vehicle charging stations serving public housing are required to comply with the California Building Code, Chapter 11 B.

#### **Section 4.106.4.2.2 Electric vehicle charging space (EV space) dimensions.**

Refer to local authority having jurisdiction for parking dimension requirements.

4.106.4.2.3 Deleted

4.106.4.2.4 Deleted

4.106.4.2.5 Deleted

Chapter 5 Section 5.106.5.3 Electric vehicle (EV) charging thru 5.106.5.3.5 are deleted and replaced to read as follows, based upon express findings set forth in this Ordinance

**Section 5.106.5.3 thru 5.106.5.3.5 are amended to read as follows:**

**5.106.5.3 Electric vehicle (EV) charging.**

[N] New construction shall comply with Section 5.106.5.3.1 or Section 5.106.5.3.2 to facilitate future installation and use of EV.

Exceptions:

1. Where there is no commercial power supply.

**5.106.5.3.1 Office and Institutional buildings.**

In nonresidential new construction buildings designated primarily for office use and institutional buildings, with parking:

1. When 10 or more parking spaces are constructed, 50% of the available parking spaces on site shall be equipped with Level 2 EVCS;
2. An additional 20% shall be provided with at least Level 1 EV Ready Spaces; and
3. An additional 30% shall be at least Level 2 EV Capable.

Calculations for the required minimum number of spaces equipped with Level 2 EVCS, Level 1 EV Ready spaces and EV Capable spaces shall all be rounded up to the nearest whole number.

Construction plans and specifications shall demonstrate that all raceways shall be a minimum of 1” and sufficient for installation of EVCS at all required Level 1 EV Ready and EV Capable spaces; Electrical calculations shall substantiate the design of the electrical system to include the rating of equipment and any on-site distribution transformers, and have sufficient capacity to simultaneously charge EVs at all required EV spaces including Level 1 EV Ready and EV Capable spaces; and service panel or subpanel(s) shall have sufficient capacity to accommodate the required number of dedicated branch circuit(s) for the future installation of the EVSE.

Notes:

1. ALMS may be installed to increase the number of EV chargers or the amperage or voltage beyond the minimum requirements in this code. The option does not allow for installing less electrical panel capacity than would be required without ALMS.

**5.106.5.3.2 Other nonresidential buildings.**

In nonresidential new construction buildings that are not designated primarily for office use, such as those for retail uses:

1. When 10 or more parking spaces are constructed, 6% of the available parking spaces on site shall be equipped with Level 2 EVCS;
2. An additional 5% shall be at least Level 1 EV Ready.  
Calculations for the required minimum number of spaces equipped with Level 2 EVCS and Level 1 EV Ready spaces shall be rounded up to the nearest whole number

Exception: Installation of each Direct Current Fast Charger with the capacity to provide at least 80 kW output may substitute for six Level 2 EVCS and five EV Ready spaces after a minimum of six Level 2 EVCS and five Level 1 EV Ready spaces are installed.

**5.106.5.3.3 Clean Air Vehicle Parking Designation.**

EVCS qualify as designated parking as described in Section 5.106.5.2 Designated parking for clean air vehicles.

Notes:

1. The California Department of Transportation adopts and publishes the California Manual on Uniform Traffic Control Devices (California MUTCD) to provide uniform standards and specifications for all official traffic control devices in California. Zero Emission Vehicle Signs and Pavement Markings can be found in the New Policies & Directives number 13-01. [www.dot.ca.gov/hq/traffops/policy/13-01.pdf](http://www.dot.ca.gov/hq/traffops/policy/13-01.pdf).
2. See Vehicle Code Section 22511 for EV charging spaces signage in off-street parking facilities and for use of EV charging spaces.
3. The Governor's Office of Planning and Research published a Zero-Emission Vehicle Community Readiness Guidebook which provides helpful information for local governments, residents and businesses. [www.opr.ca.gov/docs/ZEV\\_Guidebook.pdf](http://www.opr.ca.gov/docs/ZEV_Guidebook.pdf).
4. Section 11B-812 of the California Building Code requires that a facility providing EVCS for public and common use also provide one or more accessible EVCS as specified in Table 11B-228.3.2.1.
5. It is encouraged that shared parking, EV Ready are designated as "EV preferred."

**5.106.5.3.4 [N] Identification.**

The raceway termination location shall be permanently and visibly marked as "EV Ready".

**5.106.5.3.5 Deleted.****Section 12.26.030 Definitions.**

For the purpose of this chapter, certain words and phrases used herein are defined as follows:

**“Affordable Housing”** means a housing development project, as defined in Government Code Section 65589.5(h)(2), in which at least forty percent (40%) of the units within the project are required by deed, regulatory restriction contained in an agreement with a government agency, or other recorded document, to be made available at an affordable housing cost as defined in Health and Safety Code Section 50052.5, or at an affordable rent as defined in Health and Safety Code Section 50053, to persons and families of low or moderate income as defined by Section 50093 of the Health and Safety Code, lower income households as defined by Section 50079.5 of the Health and Safety Code, very low income households as defined by Section 50105 of the Health and Safety Code, or extremely low income households as defined by Section 50106 of the Health and Safety Code, for a period of 55 years for rental housing or 45 years for owner-occupied housing.

**“Automatic Load Management Systems (ALMS)”** means a control system which allows multiple EV chargers or EV-Ready electric vehicle outlets to share a circuit or panel and automatically reduce power at each charger, providing the opportunity to reduce electrical infrastructure costs and/or provide demand response capability. ALMS systems must be designed to deliver at least 1.4kW to each EV Capable, EV Ready or EVCS space served by the ALMS. The connected amperage on-site shall not be lower than the required connected amperage per Part 11, 2019 California Green Building Code for the relevant building types.

**“Build It Green”** means the Build It Green organization. Build It Green is a California professional non-profit membership organization whose mission is to promote healthy, energy and resource-efficient buildings.

**“Direct Current Fast Chargers”** capable of charging at 20-400kW and delivers DC power directly to the battery and therefore able to charge faster. Examples of this type of charger include Superchargers and DC Fast Chargers currently used at some public and commercial sites.

**“Electric Vehicle Charging Station (EVCS)”** means a parking space that includes installation of electric vehicle supply equipment (EVSE) with a minimum capacity of 30 amperes connected to a circuit serving a Level 2 EV Ready Space. EVCS installation may be used to satisfy a Level 2 EV Ready Space requirement.

**“EV Capable”** means a parking space linked to a listed electrical panel with sufficient capacity to provide at least 110/120 volts and 20 amperes to the parking space. Raceways linking the electrical panel and parking space only need to be installed in spaces that will be inaccessible in the future, either trenched underground or where penetrations to walls, floors, or other partitions would otherwise be required for future installation of branch circuits. Raceways must be at least 1” in diameter and may be sized for multiple circuits as allowed by the California Electrical Code. The panel circuit directory shall identify the overcurrent protective device space(s) reserved for EV charging as “EV CAPABLE.” Construction documents shall indicate future completion of raceway from the panel to the parking space, via the installed inaccessible raceways.

**“Green Point Rated”** means the rating system developed by Build It Green.

**“LEED”** means the “Leadership in Energy and Environmental Design” program developed by the U.S. Green Building Council. The U.S. Green Building Council is a National professional non-profit membership organization whose mission is to promote buildings that are environmentally responsible.

**“LEED Accredited Professional”** means a person or organization determined by the Building Official to be qualified to perform inspections and provide documentation to assure compliance with the U.S. Green Building Council LEED requirements.

**“Level 1 EV Ready Space”** means a parking space served by a complete electric circuit with a minimum of 110/120 volt, 20-ampere capacity including electrical panel capacity, overprotection device, a minimum 1” diameter raceway that may include multiple circuits as allowed by the California Electrical Code, wiring, and either a) a receptacle labelled “Electric Vehicle Outlet” with at least a ½” font adjacent to the parking space, or b) electric vehicle supply equipment (EVSE).

**“Level 2 EV Ready Space”** means a parking space served by a complete electric circuit with 208/240 volt, 40-ampere capacity including electrical panel capacity, overprotection device, a minimum 1” diameter raceway that may include multiple circuits as allowed by the California Electrical Code, wiring, and either a) a receptacle labelled “Electric Vehicle Outlet” with at least a ½” font adjacent to the parking space, or b) electric vehicle supply equipment (EVSE) with a minimum output of 30 amperes.

**“Qualified Green Building Professional”** means a person trained through the USGBC as a “LEED AP” (accredited professional), or through Build It Green as a GreenPoint Rater, or other qualifications when acceptable to the Building Official. A certified green building professional, architect, designer, builder, or building inspector may be considered a qualified green building professional when determined appropriate by the Building Official.

**“Structural Renovations”** means existing portions of roof framing and/or exterior walls removed for the purpose of rebuilding and remodeling.

### **SECTION 3. CONSTITUTIONALITY.**

If any section, subsection, sentence, clause or phrase of this code is for any reason held to be invalid or unconstitutional, such decision shall not affect the validity of the remaining portions of this code.

### **SECTION 4. CEQA.**

The City Council hereby finds and determines that this Ordinance has been assessed in accordance with the California Environmental Quality Act (Cal. Pub. Res. Code, § 21000 et seq.) (“CEQA”) and the State CEQA Guidelines (14 Cal. Code Regs. § 15000 et seq.) and is categorically exempt from CEQA under CEQA Guidelines, § 15061(b)(3), which exempts from CEQA any project where it can be seen with certainty that there is no possibility that the activity in question may have a significant effect on the environment. Adoption of the proposed Ordinance would not be an activity with potential to cause significant adverse effect on the environment because the changes made to the California Green Buildings Standards Code within are enacted to provide more protection to the environment, and therefore is exempt from CEQA. It is also exempt from CEQA pursuant to CEQA Guidelines, § 15308 which exempts actions taken by regulatory agencies for the



enhancement and protection of the environment. As such, the Ordinance is categorically exempt from CEQA.

**SECTION 5. PUBLICATION.**

This Ordinance shall be published as provided in Government Code section 36933.

**SECTION 6. EFFECTIVE DATE.**

This Ordinance shall be effective upon the commencement of the thirty-first (31st) day following the adoption date.

The foregoing Ordinance was duly and properly introduced at a regular meeting of the City Council of the City of Los Altos held on \_\_\_\_\_, 2020 and was thereafter, at a regular meeting held on \_\_\_\_\_, 2020 passed and adopted by the following vote:

- AYES:
- NOES:
- ABSENT:
- ABSTAIN:

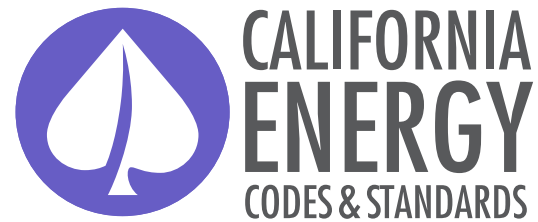
---

Jan Pepper, Mayor

ATTEST

---

Andrea Chelemengos MMC, City Clerk



A STATEWIDE UTILITY PROGRAM

Title 24, Parts 6 and 11  
Local Energy Efficiency Ordinances

## **2019 Cost-effectiveness Study: Low-Rise Residential New Construction**

**Prepared for:**  
Kelly Cunningham  
Codes and Standards Program  
Pacific Gas and Electric Company

**Prepared by:**  
Frontier Energy, Inc.  
Misti Bruceri & Associates, LLC

Last Modified: August 01, 2019

**LEGAL NOTICE**

This report was prepared by Pacific Gas and Electric Company and funded by the California utility customers under the auspices of the California Public Utilities Commission.

Copyright 2019, Pacific Gas and Electric Company. All rights reserved, except that this document may be used, copied, and distributed without modification.

Neither PG&E nor any of its employees makes any warranty, express or implied; or assumes any legal liability or responsibility for the accuracy, completeness or usefulness of any data, information, method, product, policy or process disclosed in this document; or represents that its use will not infringe any privately-owned rights including, but not limited to, patents, trademarks or copyrights.

## Table of Contents

Acronyms.....	5
1 Introduction.....	1
2 Methodology and Assumptions.....	1
2.1 Building Prototypes .....	1
2.2 Measure Analysis.....	3
2.2.1 Federal Preemption .....	4
2.2.2 Energy Design Rating .....	4
2.2.3 Energy Efficiency Measures.....	5
2.3 Package Development .....	8
2.3.1 Solar Photovoltaics (PV) .....	8
2.3.2 Energy Storage (Batteries).....	8
2.4 Incremental Costs .....	9
2.5 Cost-effectiveness .....	13
2.5.1 On-Bill Customer Lifecycle Cost.....	13
2.5.2 TDV Lifecycle Cost.....	15
2.6 Electrification Evaluation.....	15
2.7 Greenhouse Gas Emissions.....	18
3 Results .....	18
3.1 PV and Battery System Sizing .....	19
3.2 Single Family Results .....	21
3.2.1 GHG Emission Reductions .....	26
3.3 Multifamily Results.....	26
3.3.1 GHG Emission Reductions .....	32
3.4 Electrification Results .....	32
3.4.1 Single Family .....	33
3.4.2 Multifamily .....	33
4 Conclusions & Summary .....	41
5 References.....	44
Appendix A – California Climate Zone Map.....	46
Appendix B – Utility Tariff Details.....	47
Appendix C – Single Family Detailed Results.....	57
Appendix D – Single Family Measure Summary.....	61
Appendix E – Multifamily Detailed Results .....	68
Appendix F – Multifamily Measure Summary .....	72
Appendix G – Results by Climate Zone .....	79

## List of Tables

Table 1: Prototype Characteristics .....	2
Table 2: Characteristics of the Mixed Fuel vs All-Electric Prototype.....	3
Table 3: Lifetime of Water Heating & Space Conditioning Equipment Measures .....	9
Table 4: Incremental Cost Assumptions .....	10
Table 5: IOU Utility Tariffs Applied Based on Climate Zone .....	14
Table 6: Incremental Costs – All-Electric Code Compliant Home Compared to a Mixed Fuel Code Compliant Home .....	16
Table 7: PV & Battery Sizing Details by Package Type.....	20
Table 8: Single Family Package Lifetime Incremental Costs.....	22
Table 9: Single Family Package Cost-Effectiveness Results for the Mixed Fuel Case <sup>1,2</sup> .....	23
Table 10: Single Family Package Cost-Effectiveness Results for the All-Electric Case <sup>1,2</sup> .....	24
Table 11: Multifamily Package Incremental Costs per Dwelling Unit .....	28
Table 12: Multifamily Package Cost-Effectiveness Results for the Mixed Fuel Case <sup>1,2</sup> .....	29
Table 13: Multifamily Package Cost-effectiveness Results for the All-Electric Case <sup>1,2</sup> .....	30
Table 14: Single Family Electrification Results .....	34
Table 15: Comparison of Single Family On-Bill Cost Effectiveness Results with Additional PV .....	36
Table 16: Multifamily Electrification Results (Per Dwelling Unit) .....	38
Table 17: Comparison of Multifamily On-Bill Cost Effectiveness Results with Additional PV (Per Dwelling Unit) .....	39
Table 18: Summary of Single Family Target EDR Margins.....	43
Table 19: Summary of Multifamily Target EDR Margins .....	43
Table 20: PG&E Baseline Territory by Climate Zone .....	48
Table 21: SCE Baseline Territory by Climate Zone.....	51
Table 22: SoCalGas Baseline Territory by Climate Zone.....	53
Table 23: SDG&E Baseline Territory by Climate Zone .....	54
Table 24: Real Utility Rate Escalation Rate Assumptions .....	56
Table 25: Single Family Mixed Fuel Efficiency Package Cost-Effectiveness Results.....	57
Table 26: Single Family Mixed Fuel Efficiency & PV/Battery Package Cost-Effectiveness Results.....	58
Table 27: Single Family All-Electric Efficiency Package Cost-Effectiveness Results .....	59
Table 28: Single Family All-Electric Efficiency & PV-PV/Battery Package Cost-Effectiveness Results.....	60
Table 29: Single Family Mixed Fuel Efficiency – Non-Preempted Package Measure Summary .....	61
Table 30: Single Family Mixed Fuel Efficiency – Equipment, Preempted Package Measure Summary .....	62
Table 31: Single Family Mixed Fuel Efficiency & PV/Battery Package Measure Summary .....	63
Table 32: Single Family All-Electric Efficiency – Non-Preempted Package Measure Summary .....	64
Table 33: Single Family All-Electric Efficiency – Equipment, Preempted Package Measure Summary .....	65
Table 34: Single Family All-Electric Efficiency & PV Package Measure Summary .....	66
Table 35: Single Family All-Electric Efficiency & PV/Battery Package Measure Summary.....	67
Table 36: Multifamily Mixed Fuel Efficiency Package Cost-Effectiveness Results .....	68
Table 37: Multifamily Mixed Fuel Efficiency & PV/Battery Package Cost-Effectiveness Results .....	69
Table 38: Multifamily All-Electric Efficiency Package Cost-Effectiveness Results .....	70
Table 39: Multifamily All-Electric Efficiency & PV-PV/Battery Package Cost-Effectiveness Results .....	71
Table 40: Multifamily Mixed Fuel Efficiency – Non-Preempted Package Measure Summary .....	72
Table 41: Multifamily Mixed Fuel Efficiency – Equipment, Preempted Package Measure Summary .....	73
Table 42: Multifamily Mixed Fuel Efficiency & PV/Battery Package Measure Summary .....	74
Table 43: Multifamily All-Electric Efficiency – Non-Preempted Package Measure Summary.....	75
Table 44: Multifamily All-Electric Efficiency – Equipment, Preempted Package Measure Summary .....	76
Table 45: Multifamily All-Electric Efficiency & PV Package Measure Summary.....	77
Table 46: Multifamily All-Electric Efficiency & PV/Battery Package Measure Summary .....	78
Table 47: Single Family Climate Zone 1 Results Summary .....	80

Table 48: Multifamily Climate Zone 1 Results Summary (Per Dwelling Unit) .....	81
Table 49: Single Family Climate Zone 2 Results Summary .....	82
Table 50: Multifamily Climate Zone 2 Results Summary (Per Dwelling Unit) .....	83
Table 51: Single Family Climate Zone 3 Results Summary .....	84
Table 52: Multifamily Climate Zone 3 Results Summary (Per Dwelling Unit) .....	85
Table 53: Single Family Climate Zone 4 Results Summary .....	86
Table 54: Multifamily Climate Zone 4 Results Summary (Per Dwelling Unit) .....	87
Table 55: Single Family Climate Zone 5 PG&E Results Summary .....	88
Table 56: Multifamily Climate Zone 5 PG&E Results Summary (Per Dwelling Unit) .....	89
Table 57: Single Family Climate Zone 5 PG&E/SoCalGas Results Summary.....	90
Table 58: Multifamily Climate Zone 5 PG&E/SoCalGas Results Summary (Per Dwelling Unit).....	91
Table 59: Single Family Climate Zone 6 Results Summary .....	92
Table 60: Multifamily Climate Zone 6 Results Summary (Per Dwelling Unit) .....	93
Table 61: Single Family Climate Zone 7 Results Summary .....	94
Table 62: Multifamily Climate Zone 7 Results Summary (Per Dwelling Unit) .....	95
Table 63: Single Family Climate Zone 8 Results Summary .....	96
Table 64: Multifamily Climate Zone 8 Results Summary (Per Dwelling Unit) .....	97
Table 65: Single Family Climate Zone 9 Results Summary .....	98
Table 66: Multifamily Climate Zone 9 Results Summary (Per Dwelling Unit) .....	99
Table 67: Single Family Climate Zone 10 SCE/SoCalGas Results Summary .....	100
Table 68: Multifamily Climate Zone 10 SCE/SoCalGas Results Summary (Per Dwelling Unit).....	101
Table 69: Single Family Climate Zone 10 SDGE Results Summary.....	102
Table 70: Multifamily Climate Zone 10 SDGE Results Summary (Per Dwelling Unit).....	103
Table 71: Single Family Climate Zone 11 Results Summary .....	104
Table 72: Multifamily Climate Zone 11 Results Summary (Per Dwelling Unit) .....	105
Table 73: Single Family Climate Zone 12 Results Summary .....	106
Table 74: Multifamily Climate Zone 12 Results Summary (Per Dwelling Unit) .....	107
Table 75: Single Family Climate Zone 13 Results Summary .....	108
Table 76: Multifamily Climate Zone 13 Results Summary (Per Dwelling Unit) .....	109
Table 77: Single Family Climate Zone 14 SCE/SoCalGas Results Summary .....	110
Table 78: Multifamily Climate Zone 14 SCE/SoCalGas Results Summary (Per Dwelling Unit).....	111
Table 79: Single Family Climate Zone 14 SDGE Results Summary.....	112
Table 80: Multifamily Climate Zone 14 SDGE Results Summary (Per Dwelling Unit).....	113
Table 81: Single Family Climate Zone 15 Results Summary .....	114
Table 82: Multifamily Climate Zone 15 Results Summary (Per Dwelling Unit) .....	115
Table 83: Single Family Climate Zone 16 Results Summary .....	116
Table 84: Multifamily Climate Zone 16 Results Summary (Per Dwelling Unit) .....	117

## List of Figures

Figure 1: Graphical description of EDR scores (courtesy of Energy Code Ace) .....	5
Figure 2: B/C ratio comparison for PV and battery sizing .....	20
Figure 3: Single family Total EDR comparison .....	25
Figure 4: Single family EDR Margin comparison (based on Efficiency EDR Margin for the Efficiency packages and the Total EDR Margin for the Efficiency & PV and Efficiency & PV/Battery packages).....	25
Figure 5: Single family greenhouse gas emissions comparison.....	26
Figure 6: Multifamily Total EDR comparison.....	31
Figure 7: Multifamily EDR Margin comparison (based on Efficiency EDR Margin for the Efficiency packages and the Total EDR Margin for the Efficiency & PV and Efficiency & PV/Battery packages).....	31
Figure 8: Multifamily greenhouse gas emissions comparison .....	32

Figure 9: B/C ratio results for a single family all-electric code compliant home versus a mixed fuel code compliant home..... 36

Figure 10: B/C ratio results for the single family Efficiency & PV all-electric home versus a mixed fuel code compliant home ..... 37

Figure 11: B/C ratio results for the single family neutral cost package all-electric home versus a mixed fuel code compliant home ..... 37

Figure 12: B/C ratio results for a multifamily all-electric code compliant home versus a mixed fuel code compliant home ..... 40

Figure 13: B/C ratio results for the multifamily Efficiency & PV all-electric home versus a mixed fuel code compliant home ..... 40

Figure 14: B/C ratio results for the multifamily neutral cost package all-electric home versus a mixed fuel code compliant home ..... 41

Figure 15: Map of California Climate Zones (courtesy of the California Energy Commission) ..... 46

## Acronyms

2020 PV\$	Present value costs in 2020
ACH50	Air Changes per Hour at 50 pascals pressure differential
ACM	Alternative Calculation Method
AFUE	Annual Fuel Utilization Efficiency
B/C	Lifecycle Benefit-to-Cost Ratio
BEopt	Building Energy Optimization Tool
BSC	Building Standards Commission
CAHP	California Advanced Homes Program
CBECC-Res	Computer program developed by the California Energy Commission for use in demonstrating compliance with the California Residential Building Energy Efficiency Standards
CFI	California Flexible Installation
CFM	Cubic Feet per Minute
CMFNH	California Multifamily New Homes
CO <sub>2</sub>	Carbon Dioxide
CPC	California Plumbing Code
CZ	California Climate Zone
DHW	Domestic Hot Water
DOE	Department of Energy
DWHR	Drain Water Heat Recovery
EDR	Energy Design Rating
EER	Energy Efficiency Ratio
EF	Energy Factor
GHG	Greenhouse Gas
HERS Rater	Home Energy Rating System Rater
HPA	High Performance Attic
HPWH	Heat Pump Water Heater
HSPF	Heating Seasonal Performance Factor
HVAC	Heating, Ventilation, and Air Conditioning
IECC	International Energy Conservation Code
IOU	Investor Owned Utility
kBtu	kilo-British thermal unit
kWh	Kilowatt Hour
LBNL	Lawrence Berkeley National Laboratory



LCC	Lifecycle Cost
LLAHU	Low Leakage Air Handler Unit
VLLDCS	Verified Low Leakage Ducts in Conditioned Space
MF	Multifamily
NAECA	National Appliance Energy Conservation Act
NEEA	Northwest Energy Efficiency Alliance
NEM	Net Energy Metering
NPV	Net Present Value
NREL	National Renewable Energy Laboratory
PG&E	Pacific Gas and Electric Company
PV	Photovoltaic
SCE	Southern California Edison
SDG&E	San Diego Gas and Electric
SEER	Seasonal Energy Efficiency Ratio
SF	Single Family
CASE	Codes and Standards Enhancement
TDV	Time Dependent Valuation
Therm	Unit for quantity of heat that equals 100,000 British thermal units
Title 24	Title 24, Part 6
TOU	Time-Of-Use
UEF	Uniform Energy Factor
ZNE	Zero-net Energy

# 1 Introduction

The California Building Energy Efficiency Standards Title 24, Part 6 (Title 24) (Energy Commission, 2018b) is maintained and updated every three years by two state agencies, the California Energy Commission (Energy Commission) and the Building Standards Commission (BSC). In addition to enforcing the code, local jurisdictions have the authority to adopt local energy efficiency ordinances, or reach codes, that exceed the minimum standards defined by Title 24 (as established by Public Resources Code Section 25402.1(h)2 and Section 10-106 of the Building Energy Efficiency Standards). Local jurisdictions must demonstrate that the requirements of the proposed ordinance are cost-effective and do not result in buildings consuming more energy than is permitted by Title 24. In addition, the jurisdiction must obtain approval from the Energy Commission and file the ordinance with the BSC for the ordinance to be legally enforceable.

This report documents cost-effective combinations of measures that exceed the minimum state requirements, the 2019 Building Energy Efficiency Standards, effective January 1, 2020, for new single family and low-rise (one- to three-story) multifamily residential construction. The analysis includes evaluation of both mixed fuel and all-electric homes, documenting that the performance requirements can be met by either type of building design. Compliance package options and cost-effectiveness analysis in all sixteen California climate zones (CZs) are presented (see Appendix A – California Climate Zone Map for a graphical depiction of Climate Zone locations). All proposed package options include a combination of efficiency measures and on-site renewable energy.

## 2 Methodology and Assumptions

This analysis uses two different metrics to assess cost-effectiveness. Both methodologies require estimating and quantifying the incremental costs and energy savings associated with energy efficiency measures. The main difference between the methodologies is the manner in which they value energy and thus the cost savings of reduced or avoided energy use.

- **Utility Bill Impacts (On-Bill):** Customer-based Lifecycle Cost (LCC) approach that values energy based upon estimated site energy usage and customer on-bill savings using electricity and natural gas utility rate schedules over a 30-year duration accounting for discount rate and energy cost inflation.
- **Time Dependent Valuation (TDV):** Energy Commission LCC methodology, which is intended to capture the “societal value or cost” of energy use including long-term projected costs such as the cost of providing energy during peak periods of demand and other societal costs such as projected costs for carbon emissions, as well as grid transmission and distribution impacts. This metric values energy use differently depending on the fuel source (gas, electricity, and propane), time of day, and season. Electricity used (or saved) during peak periods has a much higher value than electricity used (or saved) during off-peak periods (Horii et al., 2014). This is the methodology used by the Energy Commission in evaluating cost-effectiveness for efficiency measures in Title 24, Part 6.

### 2.1 Building Prototypes

The Energy Commission defines building prototypes which it uses to evaluate the cost-effectiveness of proposed changes to Title 24 requirements. At the time that this report was written, there are two single family prototypes and one low-rise multifamily prototype. All three are used in this analysis in development of the above-code packages. Table 1 describes the basic characteristics of each prototype. Additional details on the prototypes can be found in the Alternative Calculation Method (ACM) Approval Manual (Energy Commission, 2018a). The prototypes have equal geometry on all walls, windows and roof to be orientation neutral.



**Table 1: Prototype Characteristics**

Characteristic	Single Family One-Story	Single Family Two-Story	Multifamily
Conditioned Floor Area	2,100 ft <sup>2</sup>	2,700 ft <sup>2</sup>	6,960 ft <sup>2</sup> : (4) 780 ft <sup>2</sup> & (4) 960 ft <sup>2</sup> units
Num. of Stories	1	2	2
Num. of Bedrooms	3	3	(4) 1-bed & (4) 2-bed units
Window-to-Floor Area Ratio	20%	20%	15%

Source: 2019 Alternative Calculation Method Approval Manual (California Energy Commission, 2018a).

The Energy Commission's protocol for single family prototypes is to weight the simulated energy impacts by a factor that represents the distribution of single-story and two-story homes being built statewide, assuming 45 percent single-story and 55 percent two-story. Simulation results in this study are characterized according to this ratio, which is approximately equivalent to a 2,430-square foot (ft<sup>2</sup>) house.<sup>1</sup>

The methodology used in the analyses for each of the prototypical building types begins with a design that precisely meets the minimum 2019 prescriptive requirements (zero compliance margin). Table 150.1-A in the 2019 Standards (Energy Commission, 2018b) lists the prescriptive measures that determine the baseline design in each climate zone. Other features are consistent with the Standard Design in the ACM Reference Manual (Energy Commission, 2019), and are designed to meet, but not exceed, the minimum requirements. Each prototype building has the following features:

- Slab-on-grade foundation.
- Vented attic.
- High performance attic in climate zones where prescriptively required (CZ 4, 8-16) with insulation installed at the ceiling and below the roof deck per Option B. (Refer to Table 150.1-A in the 2019 Standards.)
- Ductwork located in the attic for single family and within conditioned space for multifamily.

Both mixed fuel and all-electric prototypes are evaluated in this study. While in past code cycles an all-electric home was compared to a home with gas for certain end-uses, the 2019 code includes separate prescriptive and performance paths for mixed-fuel and all-electric homes. The fuel specific characteristics of the mixed fuel and all-electric prototypes are defined according to the 2019 ACM Reference Manual and described in Table 2.<sup>2</sup>

<sup>1</sup> 2,430 ft<sup>2</sup> = (45% x 2,100 ft<sup>2</sup>) + (55% x 2,700 ft<sup>2</sup>)

<sup>2</sup> Standards Section 150.1(c)8.A.iv.a specifies that compact hot water distribution design and a drain water heat recovery system or extra PV capacity are required when a heat pump water heater is installed prescriptively. The efficiency of the distribution and the drain water heat recovery systems as well as the location of the water heater applied in this analysis are based on the Standard Design assumptions in CBECC-Res which result in a zero-compliance margin for the 2019 basecase model.



**Table 2: Characteristics of the Mixed Fuel vs All-Electric Prototype**

Characteristic	Mixed Fuel	All-Electric
Space Heating/Cooling <sup>1</sup>	Gas furnace 80 AFUE Split A/C 14 SEER, 11.7 EER	Split heat pump 8.2 HSPF, 14 SEER, 11.7 EER
Water Heater <sup>1,2, 3, 4</sup>	Gas tankless UEF = 0.81	50gal HPWH UEF = 2.0 SF: located in the garage MF CZ 2,4,6-16: located in living space MF CZ 1,3,5: located in exterior closet
Hot Water Distribution	Code minimum. All hot water lines insulated	Basic compact distribution credit, (CZ 6-8,15) Expanded compact distribution credit, compactness factor = 0.6 (CZ 1-5,9-14,16)
Drain Water Heat Recovery Efficiency	None	CZ 1: unequal flow to shower = 42% CZ 16: equal flow to shower & water heater = 65% None in other CZs
Cooking	Gas	Electric
Clothes Drying	Gas	Electric

<sup>1</sup>Equipment efficiencies are equal to minimum federal appliance efficiency standards.

<sup>2</sup>The multifamily prototype is evaluated with individual water heaters. HPWHs located in the living space do not have ducting for either inlet or exhaust air; CBECC-Res does not have the capability to model ducted HPWHs.

<sup>3</sup>UEF = uniform energy factor. HPWH = heat pump water heater. SF = single family. MF = multifamily.

<sup>4</sup>CBECC-Res applies a 50gal water heater when specifying a storage water heater. Hot water draws differ between the prototypes based on number of bedrooms.

## 2.2 Measure Analysis

The California Building Energy Code Compliance simulation tool, CBECC-RES 2019.1.0, was used to evaluate energy impacts using the 2019 Title 24 prescriptive standards as the benchmark, and the 2019 TDV values. TDV is the energy metric used by the Energy Commission since the 2005 Title 24 energy code to evaluate compliance with the Title 24 standards.

Using the 2019 baseline as the starting point, prospective energy efficiency measures were identified and modeled in each of the prototypes to determine the projected energy (Therm and kWh) and compliance impacts. A large set of parametric runs were conducted to evaluate various options and develop packages of measures that exceed minimum code performance. The analysis utilizes a parametric tool based on Micropas<sup>3</sup> to automate and manage the generation of CBECC-Res input files. This allows for quick evaluation of various efficiency measures across multiple climate zones and prototypes and improves quality control. The batch process functionality of CBECC-Res is utilized to simulate large groups of input files at once. Annual utility costs were calculated using hourly data output from CBECC-Res and electricity and natural gas tariffs for each of the investor owned utilities (IOUs).

<sup>3</sup> Developed by Ken Nittler of Enercomp, Inc.



The Reach Codes Team selected packages and measures based on cost-effectiveness as well as decades of experience with residential architects, builders, and engineers along with general knowledge of the relative acceptance of many measures.

### **2.2.1 Federal Preemption**

The Department of Energy (DOE) sets minimum efficiency standards for equipment and appliances that are federally regulated under the National Appliance Energy Conservation Act (NAECA), including heating, cooling, and water heating equipment. Since state and local governments are prohibited from adopting policies that mandate higher minimum efficiencies than the federal standards require, the focus of this study is to identify and evaluate cost-effective packages that do not include high efficiency equipment. While this study is limited by federal preemption, in practice builders may use any package of compliant measures to achieve the performance goals, including high efficiency appliances. Often, these measures are the simplest and most affordable measures to increase energy performance.

### **2.2.2 Energy Design Rating**

The 2019 Title 24 code introduces California's Energy Design Rating (EDR) as the primary metric to demonstrate compliance with the energy code. EDR is still based on TDV but it uses a building that is compliant with the 2006 International Energy Conservation Code (IECC) as the reference building. The reference building has an EDR score of 100 while a zero-net energy (ZNE) home has an EDR score of zero (Energy Commission, 2018d). See Figure 1 for a graphical representation of this. While the Reference Building is used to determine the rating, the Proposed Design is still compared to the Standard Design based on the prescriptive baseline assumptions to determine compliance.

The EDR is calculated by CBECC-Res and has two components:

1. An "Efficiency EDR" which represents the building's energy use without solar generation.<sup>4</sup>
2. A "Total EDR" that represents the final energy use of the building based on the combined impact of efficiency measures, PV generation and demand flexibility.

For a building to comply, two criteria are required:

- (1) the proposed Efficiency EDR must be equal to or less than the Efficiency EDR of the Standard Design, and
- (2) the proposed Total EDR must be equal to or less than the Total EDR of the Standard Design.

Single family prototypes used in this analysis that are minimally compliant with the 2019 Title 24 code achieve a Total EDR between 20 and 35 in most climates.

This concept, consistent with California's "loading order" which prioritizes energy efficiency ahead of renewable generation, requires projects meet a minimum Efficiency EDR before PV is credited but allows for PV to be traded off with additional efficiency when meeting the Total EDR. A project may improve on building efficiency beyond the minimum required and subsequently reduce the PV generation capacity required to achieve the required Total EDR but may not increase the size of the PV system and trade this off with a reduction of efficiency measures. Figure 1 graphically summarizes how both Efficiency EDR and PV / demand flexibility EDR are used to calculate the Total EDR used in the 2019 code and in this analysis.

---

<sup>4</sup> While there is no compliance credit for solar PV as there is under the 2016 Standards, the credit for installing electric storage battery systems that meet minimum qualifications can be applied to the Efficiency EDR.



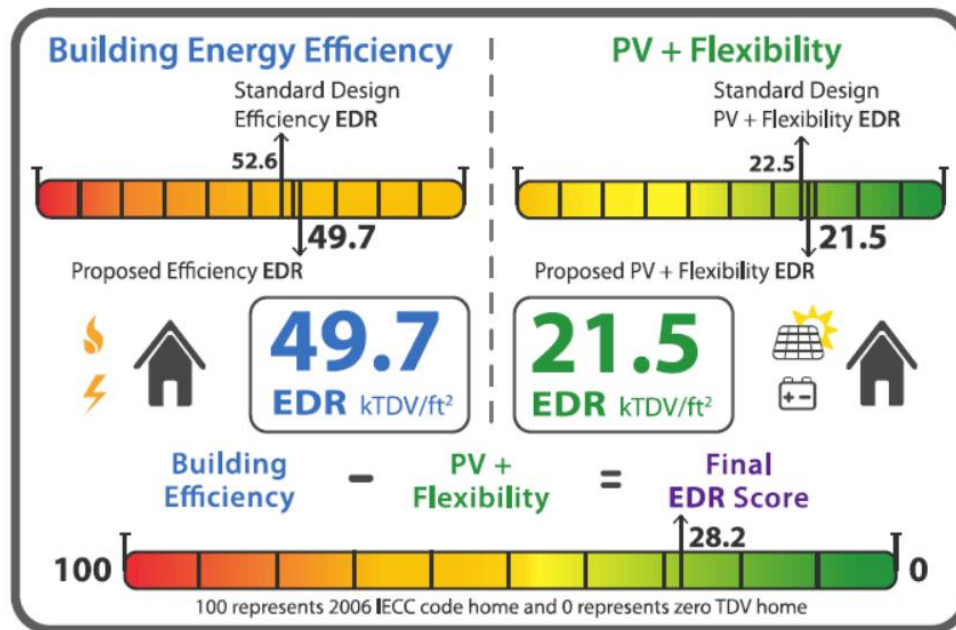


Figure 1: Graphical description of EDR scores (courtesy of Energy Code Ace<sup>5</sup>)

Results from this analysis are presented as EDR Margin, a reduction in the EDR score relative to the Standard Design. EDR Margin is a better metric to use than absolute EDR in the context of a reach code because absolute values vary, based on the home design and characteristics such as size and orientation. This approach aligns with how compliance is determined for the 2019 Title 24 code, as well as utility incentive programs, such as the California Advanced Homes Program (CAHP) & California Multifamily New Homes (CMFNH), which require minimum performance criteria based on an EDR Margin for low-rise residential projects. The EDR Margin is calculated according to Equation 1 for the two efficiency packages and Equation 2 for the Efficiency & PV and Efficiency & PV/Battery packages (see Section 2.3).

#### Equation 1

$$EDR\ Margin_{efficiency} = Standard\ Design\ \mathbf{Efficiency}\ EDR - Proposed\ Design\ \mathbf{Efficiency}\ EDR$$

#### Equation 2

$$EDR\ Margin_{efficiency\ \&\ PV} = Standard\ Design\ \mathbf{Total}\ EDR - Proposed\ Design\ \mathbf{Total}\ EDR$$

### 2.2.3 Energy Efficiency Measures

Following are descriptions of each of the efficiency measures evaluated under this analysis. Because not all of the measures described below were found to be cost-effective and cost-effectiveness varied by climate zone, not all measures are included in all packages and some of the measures listed are not included in any final package. For a list of measures included in each efficiency package by climate zone, see Appendix D – Single Family Measure Summary and Appendix F – Multifamily Measure Summary.

**Reduced Infiltration (ACH50):** Reduce infiltration in single family homes from the default infiltration assumption of five (5) air changes per hour at 50 Pascals (ACH50)<sup>6</sup> by 40 to 60 percent to either 3 ACH50 or 2 ACH50. HERS

<sup>5</sup> <https://energycodeace.com/>

<sup>6</sup> Whole house leakage tested at a pressure difference of 50 Pascals between indoors and outdoors.

rater field verification and diagnostic testing of building air leakage according to the procedures outlined in the 2019 Reference Appendices RA3.8 (Energy Commission, 2018c). This measure was not applied to multifamily homes because CBECC-Res does not allow reduced infiltration credit for multifamily buildings.

**Improved Fenestration:** Reduce window U-factor to 0.24. The prescriptive U-factor is 0.30 in all climates. In climate zones 1, 3, 5, and 16 where heating loads dominate, an increase in solar heat gain coefficient (SHGC) from the default assumption of 0.35 to 0.50 was evaluated in addition to the reduction in U-factor.

**Cool Roof:** Install a roofing product that's rated by the Cool Roof Rating Council to have an aged solar reflectance (ASR) equal to or greater than 0.25. Steep-sloped roofs were assumed in all cases. Title 24 specifies a prescriptive ASR of 0.20 for Climate Zones 10 through 15 and assumes 0.10 in other climate zones.

**Exterior Wall Insulation:** Decrease wall U-factor in 2x6 walls to 0.043 from the prescriptive requirement of 0.048 by increasing exterior insulation from one-inch R-5 to 1-1/2 inch R-7.5. This was evaluated for single family buildings only in all climate zones except 6 and 7 where the prescriptive requirement is higher (U-factor of 0.065) and improving beyond the prescriptive value has little impact.

**High Performance Attics (HPA):** HPA with R-38 ceiling insulation and R-30 insulation under the roof deck. In climates where HPA is already required prescriptively this measure requires an incremental increase in roof insulation from R-19 or R-13 to R-30. In climates where HPA is not currently required (Climate Zones 1 through 3, and 5 through 7), this measure adds roof insulation to an uninsulated roof as well as increasing ceiling insulation from R-30 to R-38 in Climate Zones 3, 5, 6 and 7.

**Slab Insulation:** Install R-10 perimeter slab insulation at a depth of 16-inches. For climate zone 16, where slab insulation is required, prescriptively this measure increases that insulation from R-7 to R-10.

**Duct Location (Ducts in Conditioned Space):** Move the ductwork and equipment from the attic to inside the conditioned space in one of the three following ways.

1. Locate ductwork in conditioned space. The air handler may remain in the attic provided that 12 linear feet or less of duct is located outside the conditioned space including the air handler and plenum. Meet the requirements of 2019 Reference Appendices RA3.1.4.1.2. (Energy Commission, 2018c)
2. All ductwork and equipment located entirely in conditioned space meeting the requirements of 2019 Reference Appendices RA3.1.4.1.3. (Energy Commission, 2018c)
3. All ductwork and equipment located entirely in conditioned space with ducts tested to have less than or equal to 25 cfm leakage to outside. Meet the requirements of Verified Low Leakage Ducts in Conditioned Space (VLLDCS) in the 2019 Reference Appendices RA3.1.4.3.8. (Energy Commission, 2018c)

Option 1 and 2 above apply to single family only since the basecase for multifamily assumes ducts are within conditioned space. Option 3 applies to both single family and multifamily cases.

**Reduced Distribution System (Duct) Leakage:** Reduce duct leakage from 5% to 2% and install a low leakage air handler unit (LLAHU). This is only applicable to single family homes since the basecase for multifamily assumes ducts are within conditioned space and additional duct leakage credit is not available.

**Low Pressure Drop Ducts:** Upgrade the duct distribution system to reduce external static pressure and meet a maximum fan efficacy of 0.35 Watts per cfm for gas furnaces and 0.45 Watts per cfm for heat pumps operating at full speed. This may involve upsizing ductwork, reducing the total effective length of ducts, and/or selecting low pressure drop components such as filters. Fan watt draw must be verified by a HERS rater according to the procedures outlined in the 2019 Reference Appendices RA3.3 (Energy Commission, 2018c). New federal regulations that went into effect July 3, 2019 require higher fan efficiency for gas furnaces than for heat pumps and air handlers, which is why the recommended specification is different for mixed fuel and all-electric homes.



**HERS Verification of Hot Water Pipe Insulation:** The California Plumbing Code (CPC) requires pipe insulation on all hot water lines. This measure provides credit for HERS rater verification of pipe insulation requirements according to the procedures outlined in the 2019 Reference Appendices RA3.6.3. (Energy Commission, 2018c)

**Compact Hot Water Distribution:** Two credits for compact hot water distribution were evaluated.

1. **Basic Credit:** Design the hot water distribution system to meet minimum requirements for the basic compact hot water distribution credit according to the procedures outlined in the 2019 Reference Appendices RA4.4.6 (Energy Commission, 2018c). In many single family homes this may require moving the water heater from an exterior to an interior garage wall. Multifamily homes with individual water heaters are expected to easily meet this credit with little or no alteration to plumbing design. CBECC-Res software assumes a 30% reduction in distribution losses for the basic credit.
2. **Expanded Credit:** Design the hot water distribution system to meet minimum requirements for the expanded compact hot water distribution credit according to the procedures outlined in the 2019 Reference Appendices RA3.6.5 (Energy Commission, 2018c). In addition to requiring HERS verification that the minimum requirements for the basic compact distribution credit are met, this credit also imposes limitations on pipe location, maximum pipe diameter, and recirculation system controls allowed.

**Drain Water Heat Recovery (DWHR):** For multifamily buildings add DWHR that serves the showers in an unequal flow configuration (pre-heated water is piped directly to the shower) with 50% efficiency. This upgrade assumes all apartments are served by a DWHR with one unit serving each apartment individually. For a slab-on-grade building this requires a horizontal unit for the first-floor apartments.

### **Federally Preempted Measures:**

The following additional measures were evaluated. Because these measures require upgrading appliances that are federally regulated to high efficiency models, they cannot be used to show cost-effectiveness in a local ordinance. The measures and packages are presented here to show that there are several options for builders to meet the performance targets. Heating and cooling capacities are autosized by CBECC-Res in all cases.

**High Efficiency Furnace:** For the mixed-fuel prototypes, upgrade natural gas furnace to one of two condensing furnace options with an efficiency of 92% or 96% AFUE.

**High Efficiency Air Conditioner:** For the mixed-fuel prototypes, upgrade the air conditioner to either single-stage SEER 16 / EER 13 or two-stage SEER 18 / EER 14 equipment.

**High Efficiency Heat Pump:** For the all-electric prototypes, upgrade the heat pump to either single-stage SEER 16 / EER 13 / HSPF 9 or two-stage SEER 18 / EER 14 / HSPF 10 equipment.

**High Efficiency Tankless Water Heater:** For the mixed-fuel prototype, upgrade tankless water heater to a condensing unit with a rated Uniform Energy Factor (UEF) of 0.96.

**High Efficiency Heat Pump Water Heater (HPWH):** For the all-electric prototypes, upgrade the federal minimum heat pump water heater to a HPWH that meets the Northwest Energy Efficiency Alliance (NEEA)<sup>7</sup> Tier 3 rating. The evaluated NEEA water heater is an 80gal unit and is applied to all three building prototypes. Using the same

---

<sup>7</sup> Based on operational challenges experienced in the past, NEEA established rating test criteria to ensure newly installed HPWHs perform adequately, especially in colder climates. The NEEA rating requires an Energy Factor equal to the ENERGY STAR performance level and includes requirements regarding noise and prioritizing heat pump use over supplemental electric resistance heating.





water heater provides consistency in performance across all the equipment upgrade cases, even though hot water draws differ across the prototypes.

### 2.3 Package Development

Three to four packages were evaluated for each prototype and climate zone, as described below.

- 1) **Efficiency – Non-Preempted**: This package uses only efficiency measures that don't trigger federal preemption issues including envelope, and water heating and duct distribution efficiency measures.
- 2) **Efficiency – Equipment, Preempted**: This package shows an alternative design that applies HVAC and water heating equipment that are more efficient than federal standards. The Reach Code Team considers this more reflective of how builders meet above code requirements in practice.
- 3) **Efficiency & PV**: Using the Efficiency – Non-Preempted Package as a starting point<sup>8</sup>, PV capacity is added to offset most of the estimated electricity use. This only applies to the all-electric case, since for the mixed fuel cases, 100% of the projected electricity use is already being offset as required by 2019 Title 24, Part 6.
- 4) **Efficiency & PV/Battery**: Using the Efficiency & PV Package as a starting point, PV capacity is added as well as a battery system.

#### 2.3.1 Solar Photovoltaics (PV)

Installation of on-site PV is required in the 2019 residential code. The PV sizing methodology in each package was developed to offset annual building electricity use and avoid oversizing which would violate net energy metering (NEM) rules.<sup>9</sup> In all cases, PV is evaluated in CBECC-Res according to the California Flexible Installation (CFI) assumptions.

The Reach Code Team used two options within the CBECC-Res software for sizing the PV system, described below. Analysis was conducted to determine the most appropriate sizing method for each package which is described in the results.

- Standard Design PV – the same PV capacity as is required for the Standard Design case<sup>10</sup>
- Specify PV System Scaling – a PV system sized to offset a specified percentage of the estimated electricity use of the Proposed Design case

#### 2.3.2 Energy Storage (Batteries)

A battery system was evaluated in CBECC-Res with control type set to "Time of Use" and with default efficiencies of 95% for both charging and discharging. The "Time of Use" option assumes batteries are charged anytime PV generation is greater than the house load but controls when the battery storage system discharges. During the summer months (July – September) the battery begins to discharge at the beginning of the peak period at a maximum rate until fully discharged. During discharge the battery first serves the house load but will

---

<sup>8</sup> In cases where there was no cost-effective Efficiency – Non-Preempted Package, the most cost-effective efficiency measures for that climate zone were also included in the Efficiency & PV Package in order to provide a combination of both efficiency and PV beyond code minimum.

<sup>9</sup> NEM rules apply to the IOU territories only.

<sup>10</sup> The Standard Design PV system is sized to offset the electricity use of the building loads which are typically electric in a mixed fuel home, which includes all loads except space heating, water heating, clothes drying, and cooking.

discharge to the electric grid if there is excess energy available. During other months the battery discharges whenever the PV system does not cover the entire house load and does not discharge to the electric grid. This control option is considered to be most reflective of the current products on the market. This control option requires an input for the “First Hour of the Summer Peak” and the Statewide CASE Team applied the default hour in CBECC-Res which differs by climate zone (either a 6pm or 7pm start). The Self Utilization Credit was taken when the battery system was modeled.

## 2.4 Incremental Costs

Table 4 below summarizes the incremental cost assumptions for measures evaluated in this study. Incremental costs represent the equipment, installation, replacement, and maintenance costs of the proposed measures relative to the base case.<sup>11</sup> Replacement costs are applied to HVAC and DHW equipment, PV inverters, and battery systems over the 30-year evaluation period. There is no assumed maintenance on the envelope, HVAC, or DHW measures since there should not be any additional maintenance cost for a more efficient version of the same system type as the baseline. Costs were estimated to reflect costs to the building owner. When costs were obtained from a source that didn’t already include builder overhead and profit, a markup of ten percent was added. All costs are provided as present value in 2020 (2020 PV\$). Costs due to variations in furnace, air conditioner, and heat pump capacity by climate zone were not accounted for in the analysis.

Equipment lifetimes applied in this analysis for the water heating and space conditioning measures are summarized in Table 3.

**Table 3: Lifetime of Water Heating & Space Conditioning Equipment Measures**

Measure	Lifetime
Gas Furnace	20
Air Conditioner	20
Heat Pump	15
Gas Tankless Water Heater	20
Heat Pump Water Heater	15

Source: City of Palo Alto 2019 Title 24 Energy Reach Code Cost-effectiveness Analysis Draft (TRC, 2018) which is based on the Database of Energy Efficiency Resources (DEER).<sup>12</sup>

<sup>11</sup> Interest costs due to financing are not included in the incremental costs presented in the Table 4 but are accounted for in the lifetime cost analysis. All first costs are assumed to be financed in a mortgage, see Section 2.5 for details.

<sup>12</sup> <http://www.deeresources.com>

**Table 4: Incremental Cost Assumptions**

Measure	Performance Level	Incremental Cost (2020 PV\$)		Source & Notes
		Single Family	Multifamily (Per Dwelling Unit)	
<b>Non-Preempted Measures</b>				
Reduced Infiltration	3.0 vs 5.0 ACH50	\$391	n/a	NREL's BEopt cost database (\$0.115/ft <sup>2</sup> for 3 ACH50 & \$0.207/ft <sup>2</sup> for 2 ACH50) + \$100 HERS rater verification.
	2.0 vs 5.0 ACH50	\$613	n/a	
Window U-factor	0.24 vs 0.30	\$2,261	\$607	\$4.23/ft <sup>2</sup> window area based on analysis conducted for the 2019 and 2022 Title 24 cycles (Statewide CASE Team, 2018).
Window SHGC	0.50 vs 0.35	\$0	\$0	Data from CASE Report along with direct feedback from Statewide CASE Team that higher SHGC does not necessarily have any incremental cost (Statewide CASE Team, 2017d). Applies to CZ 1,3,5,16.
Cool Roof - Aged Solar Reflectance	0.25 vs 0.20	\$237	\$58	Costs based on 2016 Cost-effectiveness Study for Cool Roofs reach code analysis for 0.28 solar reflectance product. (Statewide Reach Codes Team, 2017b).
	0.20 vs 0.10	\$0	\$0	
Exterior Wall Insulation	R-7.5 vs R-5	\$818	n/a	Based on increasing exterior insulation from 1" R-5 to 1.5" R-7.5 in a 2x6 wall (Statewide CASE Team, 2017c). Applies to single family only in all climates except CZ 6, 7.
Under-Deck Roof Insulation (HPA)	R-13 vs R-0	\$1,338	\$334	Costs for R-13 (\$0.64/ft <sup>2</sup> ), R-19 (\$0.78/ft <sup>2</sup> ) and R-30 (\$1.61/ft <sup>2</sup> ) based on data presented in the 2019 HPA CASE Report (Statewide CASE Team, 2017b) along with data collected directly from builders during the 2019 CASE process. The R-30 costs include additional labor costs for cabling. Costs for R-38 from NREL's BEopt cost database.
	R-19 vs R-13	\$282	\$70	
	R-30 vs R-19	\$1,831	\$457	
	R-38 vs R-30	\$585	\$146	
Attic Floor Insulation	R-38 vs R-30	\$584	\$146	NREL's BEopt cost database: \$0.34/ft <sup>2</sup> ceiling area
Slab Edge Insulation	R-10 vs R-0	\$553	\$121	\$4/linear foot of slab perimeter based on internet research. Assumes 16in depth.
	R-10 vs R-7	\$157	\$21	\$1.58/linear foot of slab perimeter based on NREL's BEopt cost database. This applies to CZ 16 only where R-7 slab edge insulation is required prescriptively. Assumes 16in depth.
Duct Location	<12 feet in attic	\$358	n/a	Costs based on a 2015 report on the Evaluation of Ducts in Conditioned Space for New California Homes (Davis Energy Group, 2015). HERS verification cost of \$100 for the Verified Low Leakage Ducts in Conditioned Space credit.
	Ducts in Conditioned Space	\$658	n/a	
	Verified Low Leakage Ducts in Conditioned Space	\$768	\$110	



**Table 4: Incremental Cost Assumptions**

Measure	Performance Level	Incremental Cost (2020 PV\$)		Source & Notes
		Single Family	Multifamily (Per Dwelling Unit)	
Distribution System Leakage	2% vs 5%	\$96	n/a	1-hour labor. Labor rate of \$96 per hour is from 2019 RSMeans for sheet metal workers and includes an average City Cost Index for labor for California cities & 10% for overhead and profit. Applies to single family only since ducts are assumed to be in conditioned space for multifamily
	Low Leakage Air Handler	\$0	n/a	Negligible cost based on review of available products. There are more than 6,000 Energy Commission certified units and the list includes many furnace and heat pump air handler product lines from the major manufacturers, including minimum efficiency, low cost product lines.
Low Pressure Drop Ducts (Fan W/cfm)	0.35 vs 0.45	\$96	\$48	Costs assume one-hour labor for single family and half-hour per multifamily apartment. Labor rate of \$96 per hour is from 2019 RSMeans for sheet metal workers and includes an average City Cost Index for labor for California cities.
	0.45 vs 0.58	\$96	\$48	
Hot Water Pipe Insulation	HERS verified	\$110	\$83	Cost for HERS verification only, based on feedback from HERS raters. \$100 per single family home and \$75 per multifamily unit before markup.
Compact Hot Water Distribution	Basic credit	\$150	\$0	For single family add 20-feet venting at \$12/ft to locate water heater on interior garage wall, less 20-feet savings for less PEX and pipe insulation at \$4.88/ft. Costs from online retailers. Many multifamily buildings are expected to meet this credit without any changes to distribution design.
	Expanded credit	n/a	\$83	Cost for HERS verification only. \$75 per multifamily unit before markup. This was only evaluated for multifamily buildings.
Drain Water Heat Recovery	50% efficiency	n/a	\$690	Cost from the 2019 DWHR CASE Report assuming a 2-inch DWHR unit. The CASE Report multifamily costs were based on one unit serving 4 dwelling units with a central water heater. Since individual water heaters serve each dwelling unit in this analysis, the Reach Code Team used single family costs from the CASE Report. Costs in the CASE Report were based on a 46.1% efficient unit, a DWHR device that meets the 50% efficiency assumed in this analysis may cost a little more. (Statewide CASE Team, 2017a).
<b>Federally Pre-empted Measures</b>				
Furnace AFUE	92% vs 80%	\$139	\$139	Equipment costs from online retailers for 40-kBtu/h unit. Cost saving for 6-feet of venting at \$26/foot due to lower cost venting requirements for condensing (PVC) vs non-condensing (stainless) furnaces. Replacement at year 20 assumes a 50% reduction in first cost. Value at year 30 based on remaining useful life is included.
	96% vs 80%	\$244	\$244	
Air Conditioner SEER/EER	16/13 vs 14/11.7	\$111	\$111	Costs from online retailers for 2-ton unit. Replacement at year 20 assumes a 50% reduction in first cost. Value at year 30 based on remaining useful life is included.
	18/14 vs 14/11.7	\$1,148	\$1,148	



**Table 4: Incremental Cost Assumptions**

Measure	Performance Level	Incremental Cost (2020 PV\$)		Source & Notes
		Single Family	Multifamily (Per Dwelling Unit)	
Heat Pump SEER/EER /HSPF	16/13/9 vs 14/11.7/8.2	\$411	\$411	Costs from online retailers for 2-ton unit. Replacement at year 15 assumes a 50% reduction in first cost.
	18/14/10 vs 14/11.7/8.2	\$1,511	\$1,511	
Tankless Water Heater Energy Factor	0.96 vs 0.81	\$203	\$203	Equipment costs from online retailers for 40-kBtu/h unit. Cost saving for 6-feet of venting at \$26/foot due to lower cost venting requirements for condensing (PVC) vs non-condensing (stainless) furnaces. Replacement at year 15 assumes a 50% reduction in first cost.
HPWH	NEEA Tier 3 vs 2.0 EF	\$294	\$294	Equipment costs from online retailers. Replacement at year 15 assumes a 50% reduction in first cost.
<b>PV + Battery</b>				
PV System	System size varies	\$3.72/W-DC	\$3.17/W-DC	First costs are from LBNL's Tracking the Sun 2018 costs (Barbose et al., 2018) and represent costs for the first half of 2018 of \$3.50/W-DC for residential system and \$2.90/W-DC for non-residential system ≤500 kW-DC. These costs were reduced by 16% for the solar investment tax credit, which is the average credit over years 2020-2022. Inverter replacement cost of \$0.14/W-DC present value includes replacements at year 11 at \$0.15/W-DC (nominal) and at year 21 at \$0.12/W-DC (nominal) per the 2019 PV CASE Report (California Energy Commission, 2017). System maintenance costs of \$0.31/W-DC present value assume \$0.02/W-DC (nominal) annually per the 2019 PV CASE Report (California Energy Commission, 2017). 10% overhead and profit added to all costs
Battery	System size varies by building type	\$656/kWh	\$656/kWh	\$633/kWh first cost based on the PV Plus Battery Study report (Statewide Reach Codes Team, 2018) as the average cost of the three systems that were analyzed. This cost was reduced by 16% for the solar investment tax credit, which is the average credit over years 2020-2022. Replacement cost at year 15 of \$100/kWh based on target price reductions (Penn, 2018).



## 2.5 Cost-effectiveness

Cost-effectiveness was evaluated for all sixteen climate zones and is presented based on both TDV energy, using the Energy Commission’s LCC methodology, and an On-Bill approach using residential customer utility rates. Both methodologies require estimating and quantifying the value of the energy impact associated with energy efficiency measures over the life of the measures (30 years) as compared to the prescriptive Title 24 requirements.

Results are presented as a lifecycle benefit-to-cost (B/C) ratio, a net present value (NPV) metric which represents the cost-effectiveness of a measure over a 30-year lifetime taking into account discounting of future savings and costs and financing of incremental first costs. A value of one indicates the NPV of the savings over the life of the measure is equivalent to the NPV of the lifetime incremental cost of that measure. A value greater than one represents a positive return on investment. The B/C ratio is calculated according to Equation 3.

### Equation 3

$$\text{Benefit – to – Cost Ratio} = \frac{\text{NPV of lifetime benefit}}{\text{NPV of lifetime cost}}$$

In most cases the benefit is represented by annual utility savings or TDV savings and the cost by incremental first cost and replacement costs. However, in some cases a measure may have incremental cost savings but with increased energy related costs. In this case, the benefit is the lower first cost and the cost is the increase in utility bills. The lifetime costs or benefits are calculated according to Equation 4.

### Equation 4

$$\text{NPV of lifetime cost/benefit} = \sum_{t=1}^n \text{Annual cost/benefit}_t * (1 + r)^t$$

Where:

- $n$  = analysis term
- $r$  = discount rate

The following summarizes the assumptions applied in this analysis to both methodologies.

- Analysis term of 30-years
- Real discount rate of 3 percent
- Inflation rate of 2 percent
- First incremental costs are financed into a 30-year mortgage
- Mortgage interest rate of 4.5 percent
- Average tax rate of 20 percent (to account for tax savings due to loan interest deductions)

### 2.5.1 On-Bill Customer Lifecycle Cost

Residential utility rates were used to calculate utility costs for all cases and determine On-Bill customer cost-effectiveness for the proposed packages. The Reach Codes Team obtained the recommended utility rates from each IOU based on the assumption that the reach codes go into effect January of 2020. Annual utility costs were calculated using hourly electricity and gas output from CBECC-Res and applying the utility tariffs summarized in Table 5. Appendix B – Utility Tariff Details includes the utility rate schedules used for this study. The applicable residential time-of-use (TOU) rate was applied to all cases.<sup>13</sup> Annual electricity production in excess of annual electricity consumption is credited to the utility account at the applicable wholesale rate based on the approved

<sup>13</sup> Under NEM rulings by the CPUC (D-16-01-144, 1/28/16), all new PV customers shall be in an approved TOU rate structure. <https://www.cpuc.ca.gov/General.aspx?id=3800>



NEM2 tariffs for that utility. Minimum daily use billing and mandatory non-bypassable charges have been applied. Future change to the NEM tariffs are likely; however, there is a lot of uncertainty about what those changes will be and if they will become effective during the 2019 code cycle (2020-2022).

The net surplus compensation rates for each utility are as follows:<sup>14</sup>

- PG&E: \$0.0287 / kWh
- SCE: \$0.0301 / kWh
- SDG&E: \$0.0355 / kWh

Utility rates were applied to each climate zone based on the predominant IOU serving the population of each zone according to Two SCE tariff options were evaluated: TOU-D-4-9 and TOU-D-PRIME. The TOU-D-PRIME rate is only available to customers with heat pumps for either space or water heating, a battery storage system, or an electric vehicle and therefore was only evaluated for the all-electric cases and the Efficiency & PV/Battery packages. The rate which resulted in the lowest annual cost to the customer was used for this analysis, which was TOU-D-4-9 in all cases with the exception of the single family all-electric cases in Climate Zone 14.

Table 5. Climate Zones 10 and 14 are evaluated with both SCE/SoCalGas and SDG&E tariffs since each utility has customers within these climate zones. Climate Zone 5 is evaluated under both PG&E and SoCalGas natural gas rates.

Two SCE tariff options were evaluated: TOU-D-4-9 and TOU-D-PRIME. The TOU-D-PRIME rate is only available to customers with heat pumps for either space or water heating, a battery storage system, or an electric vehicle and therefore was only evaluated for the all-electric cases and the Efficiency & PV/Battery packages. The rate which resulted in the lowest annual cost to the customer was used for this analysis, which was TOU-D-4-9 in all cases with the exception of the single family all-electric cases in Climate Zone 14.

**Table 5: IOU Utility Tariffs Applied Based on Climate Zone**

Climate Zones	Electric / Gas Utility	Electricity (Time-of-use)	Natural Gas
1-5, 11-13, 16	PG&E	E-TOU, Option B	G1
5	PG&E / SoCalGas	E-TOU, Option B	GR
6, 8-10, 14, 15	SCE / SoCal Gas	TOU-D-4-9 or TOU-D-PRIME	GR
7, 10, 14	SDG&E	TOU-DR1	GR

Source: Utility websites, See Appendix B – Utility Tariff Details for details on the tariffs applied.

Utility rates are assumed to escalate over time, using assumptions from research conducted by Energy and Environmental Economics (E3) in the 2019 study Residential Building Electrification in California study (Energy & Environmental Economics, 2019). Escalation of natural gas rates between 2019 and 2022 is based on the currently filed General Rate Cases (GRCs) for PG&E, SoCalGas and SDG&E. From 2023 through 2025, gas rates are assumed to escalate at 4% per year above inflation, which reflects historical rate increases between 2013 and 2018. Escalation of electricity rates from 2019 through 2025 is assumed to be 2% per year above inflation, based on electric utility estimates. After 2025, escalation rates for both natural gas and electric rates are assumed to drop to a more conservative 1% escalation per year above inflation for long-term rate trajectories beginning in 2026 through 2050. See Appendix B – Utility Tariff Details for additional details.

<sup>14</sup> Net surplus compensation rates based on 1-year average February 2018 – January 2019.

### 2.5.2 *TDV Lifecycle Cost*

Cost-effectiveness was also assessed using the Energy Commission’s TDV LCC methodology. TDV is a normalized monetary format developed and used by the Energy Commission for comparing electricity and natural gas savings, and it considers the cost of electricity and natural gas consumed during different times of the day and year. The 2019 TDV values are based on long term discounted costs of 30 years for all residential measures. The CBEC-Res simulation software outputs are in terms of TDV kBTUs. The present value of the energy cost savings in dollars is calculated by multiplying the TDV kBTU savings by a net present value (NPV) factor, also developed by the Energy Commission. The NPV factor is \$0.173/TDV kBtu for residential buildings.

Like the customer B/C ratio, a TDV B/C ratio value of one indicates the savings over the life of the measure are equivalent to the incremental cost of that measure. A value greater than one represents a positive return on investment. The ratio is calculated according to Equation 5.

#### Equation 5

$$TDV \text{ Benefit} - to - Cost \text{ Ratio} = \frac{TDV \text{ energy savings} * NPV \text{ factor}}{NPV \text{ of lifetime incremental cost}}$$

### 2.6 *Electrification Evaluation*

In addition to evaluating upgrades to mixed fuel and all-electric buildings independently that do not result in fuel switching, the Reach Code Team also analyzed the impact on construction costs, utility costs, and TDV when a builder specifies and installs electric appliances instead of the gas appliances typically found in a mixed fuel building. This analysis compared the code compliant mixed fuel prototype, which uses gas for space heating, water heating, cooking, and clothes drying, with the code compliant all-electric prototype. It also compared the all-electric Efficiency & PV Package with the code compliance mixed fuel prototype. In these cases, the relative costs between natural gas and electric appliances, differences between in-house electricity and gas infrastructure and the associated infrastructure costs for providing gas to the building were also included.

A variety of sources were reviewed when determining incremental costs. The sources are listed below.

- SMUD All-Electric Homes Electrification Case Study (EPRI, 2016)
- City of Palo Alto 2019 Title 24 Energy Reach Code Cost-effectiveness Analysis (TRC, 2018)
- Building Electrification Market Assessment (E3, 2019)
- Decarbonization of Heating Energy Use in California Buildings (Hopkins et al., 2018)
- Analysis of the Role of Gas for a Low-Carbon California Future (Navigant, 2008)
- Rulemaking No. 15-03-010 An Order Instituting Rulemaking to Identify Disadvantaged Communities in the San Joaquin Valley and Analyze Economically Feasible Options to Increase Access to Affordable Energy in Those Disadvantages Communities (California Public Utilities Commission, 2016)
- 2010-2012 WO017 Ex Ante Measure Cost Study: Final Report (Itron, 2014)
- Natural gas infrastructure costs provided by utility staff through the Reach Code subprogram
- Costs obtained from builders, contractors and developers

Incremental costs are presented in Table 6. Values in parentheses represent a lower cost or cost reduction in the electric option relative to mixed fuel. The costs from the available sources varied widely, making it difficult to develop narrow cost estimates for each component. For certain components data is provided with a low to high range as well as what were determined to be typical costs and ultimately applied in this analysis. Two sets of typical costs are presented, one which is applied in the On-Bill cost effectiveness methodology and another applied in the TDV methodology. Details of these differences are explained in the discussion of site gas infrastructure costs in the following pages.





**Table 6: Incremental Costs – All-Electric Code Compliant Home Compared to a Mixed Fuel Code Compliant Home**

Measure	Incremental Cost (2020 PV\$)				Incremental Cost (2020 PV\$)			
	Single Family <sup>1</sup>				Multifamily <sup>1</sup> (Per Dwelling Unit)			
	Low	High	Typical (On-Bill)	Typical (TDV)	Low	High	Typical (On-Bill)	Typical (TDV)
Heat Pump vs Gas Furnace/Split AC	(\$2,770)	\$620	(\$221)		Same as Single Family			
Heat Pump Water Heater vs Gas Tankless	(\$1,120)	\$1,120	\$0					
Electric vs Gas Clothes Dryer <sup>2</sup>	(\$428)	\$820	\$0					
Electric vs Gas Cooking <sup>2</sup>	\$0	\$1,800	\$0					
Electric Service Upgrade	\$200	\$800	\$600		\$150	\$600	\$600	
In-House Gas Infrastructure	(\$1,670)	(\$550)	(\$800)		(\$600)	(\$150)	(\$600)	
Site Gas Infrastructure	(\$25,000)	(\$900)	(\$5,750)	(\$11,836)	(\$16,250)	(\$310)	(\$3,140)	(\$6,463)
<b>Total First Cost</b>	<b>(\$30,788)</b>	<b>\$3,710</b>	<b>(\$6,171)</b>	<b>(\$12,257)</b>	<b>(\$20,918)</b>	<b>\$4,500</b>	<b>(\$3,361)</b>	<b>(\$6,684)</b>
<b>Present Value of Equipment Replacement Cost</b>	<b>\$1,266</b>				<b>\$1,266</b>			
<b>Lifetime Cost Including Replacement &amp; Financing of First Cost</b>			<b>(\$5,349)</b>	<b>(\$11,872)</b>			<b>(\$2,337)</b>	<b>(\$5,899)</b>

<sup>1</sup>Low and high costs represent the potential range of costs and typical represents the costs used in this analysis and determined to be most representative of the conditions described in this report. Two sets of typical costs are presented, one which is applied in the On-Bill cost effectiveness methodology and another applied in the TDV methodology.

<sup>2</sup>Typical costs assume electric resistance technology. The high range represents higher end induction cooktops and heat pump clothes dryers. Lower cost induction cooktops are available.

Typical incremental costs for switching from a mixed fuel design to an all-electric design are based on the following assumptions:

**Appliances:** The Reach Code Team determined that the typical first installed cost for electric appliances is very similar to that for natural gas appliances. This was based on information provided by HVAC contractors, plumbers and builders as well as a review of other studies. After review of various sources, the Reach Code Team concluded that the cost difference between gas and electric resistance options for clothes dryers and stoves is negligible and that the lifetimes of the two technologies are also similar.

**HVAC:** Typical HVAC incremental costs were based on the City of Palo Alto 2019 Title 24 Energy Reach Code Cost-effectiveness Analysis (TRC, 2018) which assumes approximately \$200 first cost savings for the heat pump relative to the gas furnace and air conditioner. Table 6 also includes the present value of the incremental replacement costs for the heat pump based on a 15-year lifetime and a 20-year lifetime for the gas furnace in the mixed fuel home.

**DHW:** Typical costs for the water heating system were based on equivalent installed first costs for the HPWH and tankless gas water heater. This accounts for slightly higher equipment cost but lower installation labor due to the elimination of the gas flue. Incremental replacement costs for the HPWH are based on a 15-year lifetime and a 20-year lifetime for the tankless water heater.

For multifamily, less data was available and therefore a range of low and high costs is not provided. The typical first cost for multifamily similarly is expected to be close to the same for the mixed fuel and all-electric designs. However, there are additional considerations with multifamily such as greater complexity for venting of natural gas appliances as well as for locating the HPWH within the conditioned space (all climates except Climate Zones 1, 3, and 5, see Table 2) that may impact the total costs.

**Electric service upgrade:** The study assumes an incremental cost to run 220V service to each appliance of \$200 per appliance for single family homes and \$150 per appliance per multifamily apartment based on cost estimates from builders and contractors. The Reach Code Team reviewed production builder utility plans for



mixed-fuel homes and consulted with contractors to estimate which electricity and/or natural gas services are usually provided to the dryer and oven. Typical practice varied, with some builders providing both gas and electric service to both appliances, others providing both services to only one of the appliances, and some only providing gas. For this study, the Reach Code Team determined that for single family homes the typical cost is best qualified by the practice of providing 220V service and gas to either the dryer and the oven and only gas service to the other. For multifamily buildings it's assumed that only gas is provided to the dryer and oven in the mixed fuel home.

It is assumed that no upgrades to the electrical panel are required and that a 200 Amp panel is typically installed for both mixed fuel and all-electric new construction homes. There are no incremental electrical site infrastructure requirements.

**In-house gas infrastructure (from meter to appliances)**: Installation cost to run a gas line from the meter to the appliance location is \$200 per appliance for single family and \$150 per appliance per multifamily apartment based on cost estimates from builders and contractors. The cost estimate includes providing gas to the water heater, furnace, dryer and cooktop.

**Site gas infrastructure**: The cost-effective analysis components with the highest degree of variability are the costs for on-site gas infrastructure. These costs can be project dependent and may be significantly impacted by such factors as utility territory, site characteristics, distance to the nearest gas main and main location, joint trenching, whether work is conducted by the utility or a private contractor, and number of dwelling units per development. All gas utilities participating in this study were solicited for cost information. The typical infrastructure costs for single family homes presented in Table 6 are based on cost data provided by PG&E and reflect those for a new subdivision in an undeveloped area requiring the installation of natural gas infrastructure, including a main line. Infrastructure costs for infill development can also be highly variable and may be higher than in an undeveloped area. The additional costs associated with disruption of existing roads, sidewalks, and other structures can be significant. Total typical costs in Table 6 assume \$10,000 for extension of a gas main, \$1,686 for a service lateral, and \$150 for the meter.

Utility Gas Main Extensions rules<sup>15</sup> specify that the developer has the option to only pay 50% of the total cost for a main extension after subtraction of allowances for installation of gas appliances. This 50% refund and the appliance allowance deductions are accounted for in the site gas infrastructure costs under the On-Bill cost-effectiveness methodology. The net costs to the utility after partial reimbursement from the developer are included in utility ratebase and recovered via rates to all customers. The total cost of \$5,750 presented in Table 6 reflects a 50% refund on the \$10,000 extension and appliance deductions of \$1,086 for a furnace, water heater, cooktop, and dryer. Under the On-Bill methodology this analysis assumes this developer option will remain available through 2022 and that the cost savings are passed along to the customer.

The 50% refund and appliance deductions were not applied to the site gas infrastructure costs under the TDV cost-effectiveness methodology based on input received from the Energy Commission and agreement from the Reach Code technical advisory team that the approach is appropriate. TDV cost savings impacts extend beyond the customer and account for societal impacts of energy use. Accounting for the full cost of the infrastructure upgrades was determined to be justified when evaluating under the TDV methodology.

---

<sup>15</sup> PG&E Rule 15: [https://www.pge.com/tariffs/tm2/pdf/GAS\\_RULES\\_15.pdf](https://www.pge.com/tariffs/tm2/pdf/GAS_RULES_15.pdf)

SoCalGas Rule 20: <https://www.socalgas.com/regulatory/tariffs/tm2/pdf/20.pdf>

SDG&E Rule 15: [http://regarchive.sdge.com/tm2/pdf/GAS\\_GAS-RULES\\_GRULE15.pdf](http://regarchive.sdge.com/tm2/pdf/GAS_GAS-RULES_GRULE15.pdf)



Less information was available for the costs associated with gas infrastructure for low-rise multifamily development. The typical cost in Table 6 for the On-Bill methodology is based on TRC's City of Palo Alto 2019 Title 24 Energy Reach Code Cost-effectiveness Analysis (TRC, 2018). These costs, provided by the City of Palo Alto, are approximately \$25,100 for an 8-unit new construction building and reflect connection to an existing main for infill development. Specific costs include plan review, connection charges, meter and manifold, plumbing distribution, and street cut fees. While these costs are specifically based on infill development and from one municipal utility, the estimates are less than those provided by PG&E reflecting the average cost differences charged to the developer between single family and multifamily in an undeveloped area (after accounting for deductions per the Gas Main Extensions rule). To convert costs charged to the developer to account for the full infrastructure upgrade cost (costs applied in the TDV methodology analysis), a factor of 2.06<sup>16</sup> was calculated based on the single family analysis. This same factor was applied to the multifamily cost of \$3,140 to arrive at \$6,463 (see Table 6).

## 2.7 Greenhouse Gas Emissions

Equivalent CO<sub>2</sub> emission savings were calculated based on outputs from the CBECC-Res simulation software. Electricity emissions vary by region and by hour of the year. CBECC-Res applies two distinct hourly profiles, one for Climate Zones 1 through 5 and 11 through 13 and another for Climate Zones 6 through 10 and 14 through 16. For natural gas a fixed factor of 0.005307 metric tons/therm is used. To compare the mixed fuel and all-electric cases side-by-side, greenhouse gas (GHG) emissions are presented as CO<sub>2</sub>-equivalent emissions per square foot of conditioned floor area.

## 3 Results

The primary objective of the evaluation is to identify cost-effective, non-preempted performance targets for both single family and low-rise multifamily prototypes, under both mixed fuel and all-electric cases, to support the design of local ordinances requiring new low-rise residential buildings to exceed the minimum state requirements. The packages presented are representative examples of designs and measures that can be used to meet the requirements. In practice, a builder can use any combination of non-preempted or preempted compliant measures to meet the requirements.

This analysis covered all sixteen climate zones and evaluated two efficiency packages, including a non-preempted package and a preempted package that includes upgrades to federally regulated equipment, an Efficiency & PV Package for the all-electric scenario only, and an Efficiency & PV/Battery Package. For the efficiency-only packages, measures were refined to ensure that the non-preempted package was cost-effective based on one of the two metrics applied in this study, TDV or On-Bill. The preempted equipment package, which the Reach Code Team considers to be a package of upgrades most reflective of what builders commonly apply to exceed code requirements, was designed to be cost-effective based on the On-Bill cost-effectiveness approach.

Results are presented as EDR Margin instead of compliance margin. EDR is the metric used to determine code compliance in the 2019 cycle. Target EDR Margin is based on taking the calculated EDR Margin for the case and rounding down to the next half of a whole number. Target EDR Margin for the Efficiency Package are defined based on the lower of the EDR Margin of the non-preempted package and the equipment, preempted package. For example, if for a particular case the cost-effective non-preempted package has an EDR Margin of 3 and the preempted package an EDR Margin of 4, the Target EDR Margin is set at 3.

---

<sup>16</sup> This factor includes the elimination of the 50% refund for the main extension and adding back in the appliance allowance deductions.

For a package to qualify, a minimum EDR Margin of 0.5 was required. This is to say that a package that only achieved an EDR Margin of 0.4, for example, was not considered. An EDR Margin less than 0.5 generally corresponds to a compliance margin lower than 5% and was considered too small to ensure repeatable results. In certain cases, the Reach Code Team did not identify a cost-effective package that achieved the minimum EDR Margin of 0.5.

Although some of the efficiency measures evaluated were not cost-effective and were eliminated, the following measures are included in at least one package:

- Reduced infiltration
- Improved fenestration
- Improved cool roofs
- High performance attics
- Slab insulation
- Reduced duct leakage
- Verified low leakage ducts in conditioned space
- Low pressure-drop distribution system
- Compact hot water distribution system, basic and expanded
- High efficiency furnace, air conditioner & heat pump (*preempted*)
- High efficiency tankless water heater & heat pump water heater (*preempted*)

### 3.1 PV and Battery System Sizing

The approach to determining the size of the PV and battery systems varied based on each package and the source fuel. Table 7 describes the PV and battery sizing approaches applied to each of the four packages. For the **Efficiency Non-preempted and Efficiency – Equipment, Preempted packages** a different method was applied to each the two fuel scenarios. In all **mixed fuel cases**, the PV was sized to offset 100% of the estimated electrical load and any electricity savings from efficiency measures were traded off with a smaller PV system. Not downsizing the PV system after adding efficiency measures runs the risk of producing more electricity than is consumed, reducing cost-effectiveness and violating NEM rules. While the impact of this in most cases is minor, analysis confirmed that cost-effectiveness improved when reducing the system size to offset 100% of the electricity usage as opposed to keeping the PV system the same size as the Standard Design.

In the **all-electric Efficiency cases**, the PV system size was left to match the Standard Design (Std Design PV), and the inclusion of energy efficiency measures was not traded off with a reduced capacity PV system. Because the PV system is sized to meet the electricity load of a mixed fuel home, it is cost-effective to keep the PV system the same size and offset a greater percentage of the electrical load.

For the **Efficiency & PV case on the all-electric home**, the Reach Code Team evaluated PV system sizing to offset 100%, 90% and 80% of the total calculated electricity use. Of these three, sizing to 90% proved to be the most cost-effective based on customer utility bills. This is a result of the impact of the annual minimum bill which is around \$120 across all the utilities. The “sweet spot” is a PV system that reduces electricity bills just enough to match the annual minimum bill; increasing the PV size beyond this adds first cost but does not result in utility bill savings.



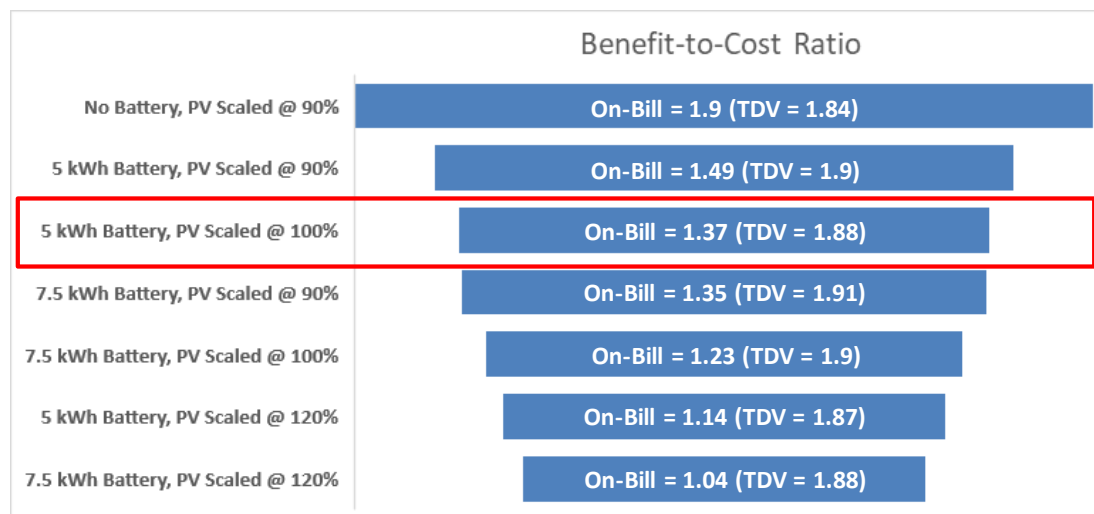
**Table 7: PV & Battery Sizing Details by Package Type**

Package	Mixed Fuel	All-Electric
Efficiency (Envelope & Equipment)	PV Scaled @ 100% electricity	Std Design PV
Efficiency & PV	n/a	PV Scaled @ 90%
Efficiency & PV/Battery	PV Scaled @ 100% electricity 5kWh / SF home 2.75kWh/ MF apt	PV Scaled @ 100% 5kWh / SF home 2.75kWh/ MF apt

A sensitivity analysis was conducted to determine the appropriate battery and PV capacity for the Efficiency & PV/Battery Packages using the 1-story 2,100 square foot prototype in Climate Zone 12. Results are shown in Figure 2. The current version of CBECC-Res requires a minimum battery size of 5 kWh to qualify for the self-utilization credit. CBECC-Res allows for PV oversizing up to 160% of the building's estimated electricity load when battery storage systems are installed; however, the Reach Code Team considered this high, potentially problematic from a grid perspective, and likely not acceptable to the utilities or customers. The Reach Code Team compared cost-effectiveness of 5kWh and 7.5kWh battery systems as well as of PV systems sized to offset 90%, 100%, or 120% of the estimated electrical load.

Results show that from an on-bill perspective a smaller battery size is more cost-effective. The sensitivity analysis also showed that increasing the PV capacity from 90% to 120% of the electricity use reduced cost-effectiveness. From the TDV perspective there was little difference in results across all the scenarios, with the larger battery size being marginally more cost-effective. Based on these results, the Reach Code Team applied to the Efficiency & PV/Battery Package a 5kWh battery system for single family homes with PV sized to offset 100% of the electricity load. Even though PV scaled to 90% was the most cost-effective, sizing was increased to 100% to evaluate greater generation beyond the Efficiency & PV Package and to achieve zero net electricity. These results also show that in isolation, the inclusion of a battery system reduces cost-effectiveness compared to the same size PV system without batteries.

For multifamily buildings the battery capacity was scaled to reflect the average ratio of battery size to PV system capacity (kWh/kW) for the single family Efficiency & PV Package. This resulted in a 22kWh battery for the multifamily building, or 2.75kWh per apartment.

**Figure 2: B/C ratio comparison for PV and battery sizing**

### 3.2 Single Family Results

Table 8 through Table 10 contain cost effectiveness findings for the single family packages. Table 8 summarizes the package costs for all of the mixed fuel and all-electric efficiency, PV and battery packages. The mixed fuel results are evaluated and presented relative to a mixed fuel code compliant basecase while the all-electric results are relative to an all-electric code compliant basecase.

Table 9 and Table 10 present the B/C ratios for all the single family packages according to both the On-Bill and TDV methodologies for the mixed fuel and the all-electric cases, respectively. Results are cost-effective based on TDV for all cases except for Climate Zone 7 where no cost-effective combination of non-preempted efficiency measures was found that met the minimum 0.5 EDR Margin threshold. Cases where the B/C ratio is indicated as “>1” refer to instances where there are incremental cost savings in addition to annual utility bill savings. In these cases, there is no cost associated with the upgrade and benefits are realized immediately.

Figure 3 presents a comparison of Total EDRs for single family buildings and Figure 4 presents the EDR Margin results. Each graph compares the mixed fuel and all-electric cases as well as the various packages. The EDR Margin for the **Efficiency Package** for most climates is between 1.0 and 5.5 for mixed fuel cases and slightly higher, between 1.5 and 6.5, for the all-electric design. No cost-effective **mixed fuel or all-electric non-preempted Efficiency package** was found Climate Zone 7.

For the **mixed fuel case, the Efficiency & PV/Battery** Package increased the EDR Margin to values between 7.0 and 10.5. Because of the limitations on oversizing PV systems to offset natural gas use it is not feasible to achieve higher EDR Margins by increasing PV system capacity.

For the **all-electric case, the Efficiency & PV** Package resulted in EDR Margins of 11.0 to 19.0 for most climates; adding a battery system increased the EDR Margin by an additional 7 to 13 points. Climate zones 1 and 16, which have high heating loads, have much higher EDR Margins for the Efficiency & PV package (26.5-31.0). The Standard Design PV, which is what is applied in the all-electric Efficiency Package, is not sized to offset any of the heating load. When the PV system is sized to offset 90% of the total electricity use, the increase is substantial as a result. In contrast, in Climate Zone 15 the Standard Design PV system is already sized to cover the cooling electricity load, which represents 40% of whole building electricity use. Therefore, increasing the PV size to offset 90% of the electric load in this climate only results in adding approximately 120 Watts of PV capacity and subsequently a negligible impact on the EDR.

Additional results details can be found in Appendix C – Single Family Detailed Results with summaries of measures included in each of the packages in Appendix D – Single Family Measure Summary. A summary of results by climate zone is presented in Appendix G – Results by Climate Zone.

**Table 8: Single Family Package Lifetime Incremental Costs**

Climate Zone	Mixed Fuel			All-Electric			
	Non-Preempted	Equipment - Preempted	Efficiency & PV/Battery	Non-Preempted	Equipment - Preempted	Efficiency & PV	Efficiency & PV/Battery
<b>CZ01</b>	+\$1,355	+\$1,280	+\$5,311	+\$7,642	+\$2,108	+\$18,192	+\$24,770
<b>CZ02</b>	+\$1,504	+\$724	+\$5,393	+\$3,943	+\$2,108	+\$12,106	+\$18,132
<b>CZ03</b>	+\$1,552	+\$1,448	+\$5,438	+\$1,519	+\$2,108	+\$8,517	+\$14,380
<b>CZ04</b>	+\$1,556	+\$758	+\$5,434	+\$1,519	+\$2,108	+\$8,786	+\$14,664
<b>CZ05</b>	+\$1,571	+\$772	+\$5,433	+\$1,519	+\$2,108	+\$8,307	+\$14,047
<b>CZ06</b>	+\$1,003	+\$581	+\$4,889	+\$926	+\$846	+\$6,341	+\$12,036
<b>CZ07</b>	n/a	+\$606	+\$4,028	n/a	+\$846	+\$4,436	+\$9,936
<b>CZ08</b>	+\$581	+\$586	+\$4,466	+\$926	+\$412	+\$5,373	+\$11,016
<b>CZ09</b>	+\$912	+\$574	+\$4,785	+\$1,180	+\$846	+\$5,778	+\$11,454
<b>CZ10</b>	+\$1,648	+\$593	+\$5,522	+\$1,773	+\$949	+\$6,405	+\$12,129
<b>CZ11</b>	+\$3,143	+\$1,222	+\$7,026	+\$3,735	+\$2,108	+\$10,827	+\$17,077
<b>CZ12</b>	+\$1,679	+\$654	+\$5,568	+\$3,735	+\$2,108	+\$11,520	+\$17,586
<b>CZ13</b>	+\$3,060	+\$611	+\$6,954	+\$4,154	+\$2,108	+\$10,532	+\$16,806
<b>CZ14</b>	+\$1,662	+\$799	+\$5,526	+\$4,154	+\$2,108	+\$10,459	+\$16,394
<b>CZ15</b>	+\$2,179	-\$936	+\$6,043	+\$4,612	+\$2,108	+\$5,085	+\$11,382
<b>CZ16</b>	+\$3,542	+\$2,441	+\$7,399	+\$5,731	+\$2,108	+\$16,582	+\$22,838



Table 9: Single Family Package Cost-Effectiveness Results for the Mixed Fuel Case <sup>1,2</sup>

CZ	Utility	Efficiency							Efficiency & PV/Battery			
		Non-Preempted			Equipment - Preempted			Target	Total	On-Bill	TDV	Target
EDR	On-Bill	TDV	EDR	On-Bill	TDV	EDR	EDR	EDR				
Margin	B/C	B/C	Margin	Ratio	Ratio	Margin	Ratio	Ratio	Margin	Ratio	Ratio	Margin
01	PG&E	5.3	3.4	2.8	6.9	4.9	4.1	5.0	10.6	0.9	1.6	10.5
02	PG&E	3.3	1.6	1.7	3.3	3.8	3.6	3.0	10.1	0.5	1.6	10.0
03	PG&E	3.0	1.3	1.3	4.1	1.9	2.0	2.5	10.0	0.4	1.4	10.0
04	PG&E	2.5	0.9	1.2	2.7	2.4	2.7	2.5	10.1	0.3	1.5	10.0
05	PG&E	2.7	1.1	1.2	2.6	2.3	2.5	2.5	9.4	0.4	1.3	9.0
05	PG&E/SoCalGas	2.7	0.9	1.2	2.6	2.0	2.5	2.5	9.4	0.3	1.3	9.0
06	SCE/SoCalGas	2.0	0.7	1.2	2.0	1.6	2.0	1.5	9.8	0.8	1.3	9.5
07	SDG&E	0.0	-	-	1.5	1.5	1.4	0.0	9.2	0.1	1.3	9.0
08	SCE/SoCalGas	1.3	0.6	1.4	1.6	1.3	1.8	1.0	8.4	0.9	1.3	8.0
09	SCE/SoCalGas	2.6	0.7	2.0	2.9	1.8	3.7	2.5	8.8	1.0	1.5	8.5
10	SCE/SoCalGas	3.2	0.6	1.3	3.2	2.0	3.8	3.0	9.6	1.0	1.5	9.5
10	SDG&E	3.2	0.8	1.3	3.2	2.6	3.8	3.0	9.6	0.6	1.5	9.5
11	PG&E	4.3	0.8	1.2	5.1	2.5	3.7	4.0	9.2	0.4	1.5	9.0
12	PG&E	3.5	1.2	1.8	3.4	3.3	4.6	3.0	9.6	0.4	1.7	9.5
13	PG&E	4.6	0.8	1.3	5.8	5.3	8.4	4.5	9.7	0.4	1.6	9.5
14	SCE/SoCalGas	5.0	1.6	2.5	5.8	4.0	6.1	4.5	9.0	1.3	1.7	9.0
14	SDG&E	5.0	1.9	2.5	5.8	4.9	6.1	4.5	9.0	1.2	1.7	9.0
15	SCE/SoCalGas	4.8	1.0	1.6	5.0	>1	>1	4.5	7.1	1.1	1.5	7.0
16	PG&E	5.4	1.6	1.5	6.2	2.2	2.2	5.0	10.5	0.9	1.4	10.5

<sup>1</sup>">1" indicates cases where there are both first cost savings and annual utility bill savings.

<sup>2</sup>Information about the measures included for each climate zone are described in Appendix D – Single Family Measure Summary.





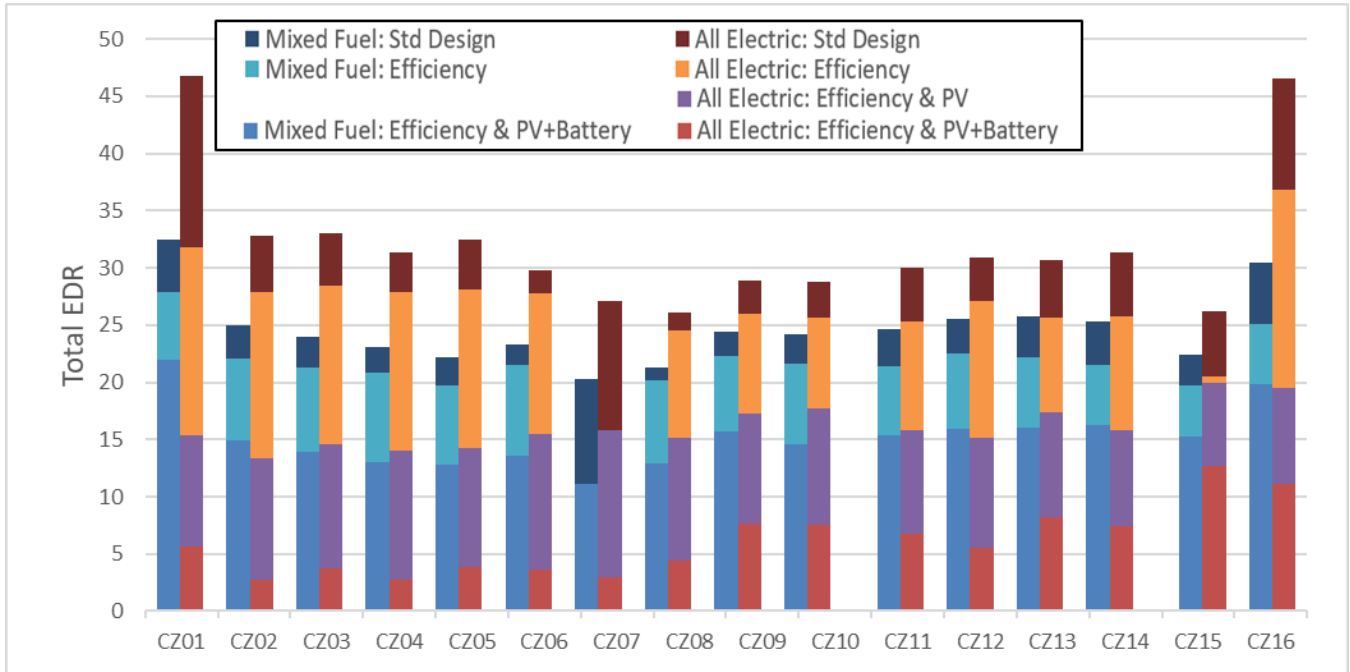
Table 10: Single Family Package Cost-Effectiveness Results for the All-Electric Case<sup>1,2</sup>

CZ	Utility	Efficiency							Efficiency & PV				Efficiency & PV/Battery			
		Non-Preempted			Equipment - Preempted			Target	Total	On-Bill	TDV	Target	Total	On-Bill	TDV	Target
		Efficiency EDR Margin	On-Bill B/C Ratio	TDV B/C Ratio	Efficiency EDR Margin	On-Bill B/C Ratio	TDV B/C Ratio	Efficiency EDR Margin								
01	PG&E	15.2	1.8	1.7	6.9	2.9	2.7	6.5	31.4	1.8	1.5	31.0	41.2	1.4	1.4	41.0
02	PG&E	4.9	1.2	1.1	5.1	2.3	2.1	4.5	19.4	1.8	1.4	19.0	30.1	1.4	1.4	30.0
03	PG&E	4.7	2.6	2.4	4.4	1.8	1.6	4.0	18.5	2.2	1.7	18.0	29.3	1.5	1.6	29.0
04	PG&E	3.4	1.9	1.8	3.9	1.5	1.5	3.0	17.2	2.1	1.6	17.0	28.6	1.5	1.6	28.5
05	PG&E	4.4	2.6	2.3	4.4	1.9	1.7	4.0	18.2	2.3	1.8	18.0	28.7	1.6	1.6	28.5
05	PG&E/SoCalGas	4.4	2.6	2.3	4.4	1.9	1.7	4.0	18.2	2.3	1.8	18.0	28.7	1.6	1.6	28.5
06	SCE/SoCalGas	2.0	1.3	1.4	2.9	2.2	2.3	2.0	14.3	1.2	1.5	14.0	26.1	1.2	1.4	26.0
07	SDG&E	0.0	-	-	2.2	1.6	1.7	0.0	11.3	1.9	1.5	11.0	24.2	1.3	1.5	24.0
08	SCE/SoCalGas	1.6	0.6	1.2	1.8	2.8	3.0	1.5	10.9	1.0	1.5	10.5	21.6	1.1	1.4	21.5
09	SCE/SoCalGas	2.8	0.8	2.0	3.3	2.1	3.2	2.5	11.5	1.1	1.6	11.5	21.3	1.1	1.5	21.0
10	SCE/SoCalGas	3.1	0.9	1.5	3.4	2.3	3.2	3.0	11.1	1.1	1.5	11.0	21.2	1.1	1.5	21.0
10	SDG&E	3.1	1.1	1.5	3.4	2.6	3.2	3.0	11.1	1.7	1.5	11.0	21.2	1.4	1.5	21.0
11	PG&E	4.6	1.2	1.5	5.9	3.0	3.3	4.5	14.2	1.8	1.6	14.0	23.2	1.5	1.6	23.0
12	PG&E	3.8	0.8	1.1	5.1	2.0	2.5	3.5	15.7	1.7	1.4	15.5	25.4	1.3	1.5	25.0
13	PG&E	5.1	1.1	1.4	6.0	2.9	3.3	5.0	13.4	1.7	1.5	13.0	22.5	1.4	1.5	22.0
14	SCE/SoCalGas	5.6	1.0	1.5	6.0	2.3	3.1	5.5	15.5	1.2	1.6	15.5	23.9	1.4	1.6	23.5
14	SDG&E	5.6	1.3	1.5	6.0	2.9	3.1	5.5	15.5	1.8	1.6	15.5	23.9	1.7	1.6	23.5
15	SCE/SoCalGas	5.6	1.1	1.6	7.3	3.3	4.5	5.5	6.2	1.1	1.6	6.0	13.5	1.2	1.5	13.0
16	PG&E	9.7	1.7	1.7	4.9	2.4	2.3	4.5	27.0	2.1	1.6	26.5	35.4	1.7	1.5	35.0

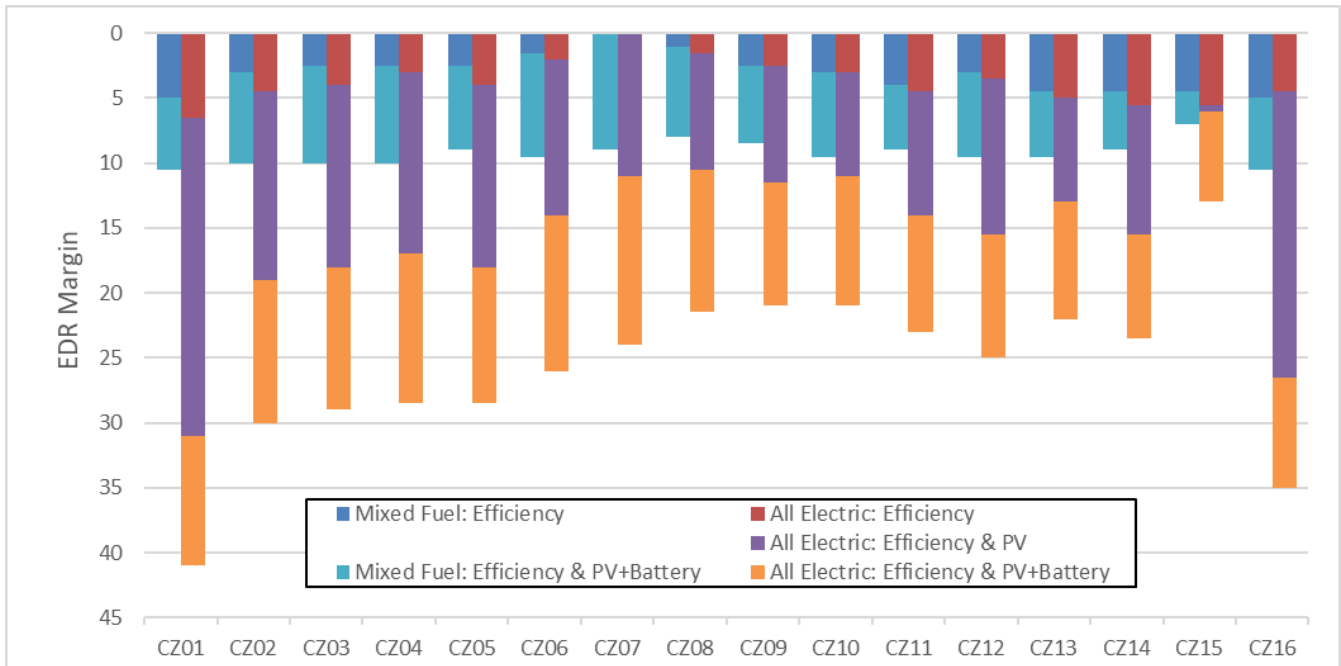
<sup>1</sup>">1" indicates cases where there are both first cost savings and annual utility bill savings.

<sup>2</sup>Information about the measures included for each climate zone are described in Appendix D – Single Family Measure Summary





**Figure 3: Single family Total EDR comparison**

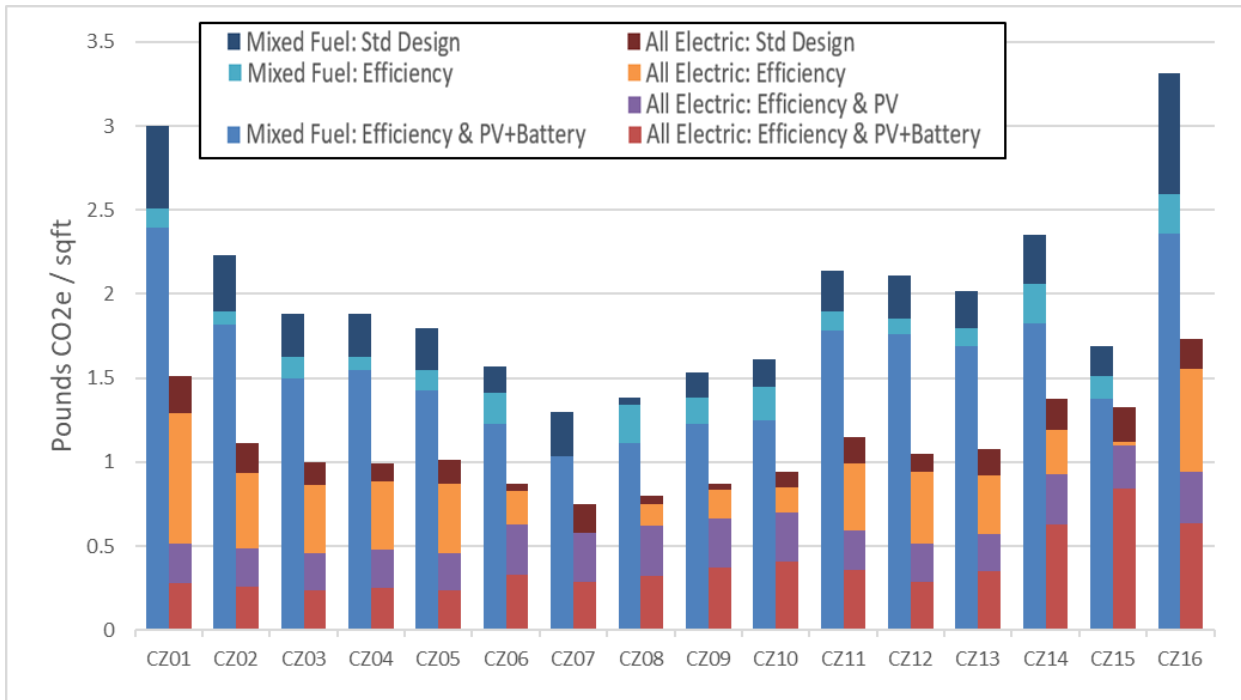


**Figure 4: Single family EDR Margin comparison (based on Efficiency EDR Margin for the Efficiency packages and the Total EDR Margin for the Efficiency & PV and Efficiency & PV/Battery packages)**



**3.2.1 GHG Emission Reductions**

Figure 5 compares annual GHG emissions for both mixed fuel and all-electric single family 2019 code compliant cases with Efficiency, Efficiency & PV and Efficiency & PV/Battery packages. GHG emissions vary by climate but are consistently higher in mixed fuel cases than all-electric. Standard Design mixed fuel emissions range from 1.3 (CZ 7) to 3.3 (CZ 16) lbs CO<sub>2</sub>e/square foot of floor area, where all-electric Standard Design emissions range from 0.7 to 1.7 lbs CO<sub>2</sub>e/ ft<sup>2</sup>. Adding efficiency, PV and batteries to the mixed fuel code compliant prototype reduces GHG emissions by 20% on average to between 1.0 and 1.8 lbs CO<sub>2</sub>e/ft<sup>2</sup>, with the exception of Climate Zones 1 and 16. Adding efficiency, PV and batteries to the all-electric code compliant prototype reduces annual GHG emissions by 65% on average to 0.8 lbs CO<sub>2</sub>e/ft<sup>2</sup> or less. None of the cases completely eliminate GHG emissions. Because of the time value of emissions calculation for electricity in CBEECC-Res, there is always some amount of GHG impacts with using electricity from the grid.



**Figure 5: Single family greenhouse gas emissions comparison**

**3.3 Multifamily Results**

Table 11 through Table 13 contain cost effectiveness findings for the multifamily packages. Table 11 summarizes the package costs for all the mixed fuel and all-electric efficiency, PV and battery packages.

Table 12 and Table 13 present the B/C ratios for all the packages according to both the On-Bill and TDV methodologies for the mixed fuel and the all-electric cases, respectively. All the packages are cost-effective based on TDV except Climate Zone 3 for the all-electric cases where no cost-effective combination of non-preempted efficiency measures was found that met the minimum 0.5 EDR Margin threshold. Cases where the B/C ratio is indicated as “>1” refer to instances where there are incremental cost savings in addition to annual utility bill savings. In these cases, there is no cost associated with this upgrade and benefits are realized immediately.

It is generally more challenging to achieve equivalent savings targets cost-effectively for the multifamily cases than for the single family cases. With less exterior surface area per floor area the impact of envelope measures



is diminished in multifamily buildings. Ducts are already assumed to be within conditioned space and therefore only one of the duct measures found to be cost-effective in single family homes can be applied.

Figure 6 presents a comparison of Total EDRs for the multifamily cases and Figure 7 presents the EDR Margin results. Each graph compares the mixed fuel and all-electric cases as well as the various packages. Cost-effective efficiency packages were found for all **mixed fuel cases**. The Target EDR Margins for the **mixed fuel Efficiency Package** are 0.5 for Climate Zones 3, 5 and 7, between 1.0 and 2.5 for Climate Zones 1, 2, 4, 6, 8 through 12 and 16, and between 3.0 and 4.0 in Climate Zones 13 through 15. For the **all-electric case, no cost-effective non-preempted efficiency packages** were found in Climate Zone 3. The Target EDR Margins are between 0.5 and 2.5 for Climate Zones 2, 4 through 10 and 12, and between 3.0 and 4.0 in Climate Zones 1, 11, and 13 through 16.

For the **mixed fuel case, the Efficiency & PV/Battery Package** results in an EDR Margin of between 8.5 and 11.5 across all climate zones. Most of these packages were not found to be cost-effective based on utility bill savings alone, but they all are cost-effective based on TDV energy savings. For the **all-electric case, the Efficiency & PV Package** resulted in EDR Margins of 10.5 to 17.5 for most climates; adding a battery system increased the EDR Margin by an additional 10 to 15 points. Climate zones 1 and 16, which have high heating loads, have much higher EDR Margins for the **Efficiency & PV package** (19.5-22.5). The Standard Design PV, which is what is applied in the **Efficiency Package**, is not sized to offset any of the heating load. When the PV system is sized to offset 90% of the total electricity use, the increase is substantial as a result. In Climate Zone 15 the Standard Design PV system is already sized to cover the cooling electricity load, which represents 30% of whole building electricity use. Therefore, increasing the PV size to offset 90% of the electric load in this climate only results in adding approximately 240 Watts of PV capacity per apartment and subsequently a much smaller impact on the EDR than in other climate zones. Because of the limitations on oversizing PV systems to offset natural gas use it is not feasible to achieve comparable EDR Margins for the mixed fuel case as in the all-electric case.

Additional results details can be found in Appendix E – Multifamily Detailed Results with summaries of measures included in each of the packages in Appendix F – Multifamily Measure Summary. A summary of results by climate zone is presented in Appendix G – Results by Climate Zone.



**Table 11: Multifamily Package Incremental Costs per Dwelling Unit**

Climate Zone	Mixed Fuel			All-Electric			
	Non-Preempted	Equipment - Preempted	Efficiency & PV/Battery	Non-Preempted	Equipment - Preempted	Efficiency & PV	Efficiency & PV/Battery
CZ01	+\$960	+\$507	+\$3,094	+\$949	+\$795	+\$5,538	+\$8,919
CZ02	+\$309	+\$497	+\$2,413	+\$361	+\$795	+\$3,711	+\$6,833
CZ03	+\$175	+\$403	+\$2,279	n/a	+\$795	+\$3,272	+\$6,344
CZ04	+\$329	+\$351	+\$2,429	+\$361	+\$795	+\$3,158	+\$6,201
CZ05	+\$180	+\$358	+\$2,273	+\$247	+\$795	+\$3,293	+\$6,314
CZ06	+\$190	+\$213	+\$2,294	+\$231	+\$361	+\$2,580	+\$5,590
CZ07	+\$90	+\$366	+\$2,188	+\$202	+\$361	+\$2,261	+\$5,203
CZ08	+\$250	+\$213	+\$2,353	+\$231	+\$361	+\$2,240	+\$5,249
CZ09	+\$136	+\$274	+\$2,234	+\$231	+\$361	+\$2,232	+\$5,236
CZ10	+\$278	+\$250	+\$2,376	+\$361	+\$361	+\$2,371	+\$5,395
CZ11	+\$850	+\$317	+\$2,950	+\$1,011	+\$795	+\$3,601	+\$6,759
CZ12	+\$291	+\$434	+\$2,394	+\$1,011	+\$795	+\$3,835	+\$6,943
CZ13	+\$831	+\$290	+\$2,936	+\$1,011	+\$795	+\$3,462	+\$6,650
CZ14	+\$874	+\$347	+\$2,957	+\$1,011	+\$795	+\$3,356	+\$6,380
CZ15	+\$510	-\$157	+\$2,604	+\$1,011	+\$1,954	+\$1,826	+\$5,020
CZ16	+\$937	+\$453	+\$3,028	+\$843	+\$795	+\$4,423	+\$7,533



Table 12: Multifamily Package Cost-Effectiveness Results for the Mixed Fuel Case<sup>1,2</sup>

CZ	Utility	Efficiency							Efficiency & PV/Battery			
		Non-Preempted			Equipment - Preempted			Target	Total	On-Bill	TDV	Target
Efficiency	On-Bill	TDV	Efficiency	On-Bill	TDV	Efficiency	Total	On-Bill				
EDR	B/C	B/C	EDR	B/C	B/C	EDR	EDR	EDR	B/C	B/C	EDR	
Margin	Ratio	Ratio	Margin	Ratio	Ratio	Margin	Margin	Margin	Ratio	Ratio	Margin	
01	PG&E	3.4	1.1	1.2	2.3	1.3	1.4	2.0	11.5	0.4	1.2	11.5
02	PG&E	1.8	1.0	1.7	2.3	1.1	1.5	1.5	10.9	0.2	1.6	10.5
03	PG&E	0.6	1.0	1.1	1.6	1.1	1.2	0.5	10.3	0.1	1.4	10.0
04	PG&E	1.3	0.8	1.2	1.9	1.1	1.7	1.0	11.2	0.2	1.6	11.0
05	PG&E	0.5	1.0	1.0	1.5	1.2	1.3	0.5	9.9	0.2	1.4	9.5
05	PG&E/SoCalGas	0.5	0.8	1.0	1.5	1.1	1.3	0.5	9.9	0.1	1.4	9.5
06	SCE/SoCalGas	1.3	0.6	1.5	1.3	1.4	1.7	1.0	10.7	0.6	1.4	10.5
07	SDG&E	0.9	0.7	2.2	2.0	1.1	1.4	0.5	11.0	0.0	1.4	11.0
08	SCE/SoCalGas	1.5	0.7	1.4	1.1	1.4	1.7	1.0	9.9	0.7	1.3	9.5
09	SCE/SoCalGas	1.8	1.5	3.3	2.8	1.7	2.9	1.5	9.7	0.9	1.5	9.5
10	SCE/SoCalGas	1.7	0.8	1.7	2.9	2.0	3.3	1.5	10.4	1.0	1.6	10.0
10	SDG&E	1.7	1.1	1.7	2.9	2.6	3.3	1.5	10.4	0.2	1.6	10.0
11	PG&E	2.9	0.7	1.2	3.2	1.8	3.3	2.5	10.5	0.4	1.6	10.5
12	PG&E	1.9	1.1	2.2	2.8	1.2	2.2	1.5	10.3	0.3	1.7	10.0
13	PG&E	3.1	0.6	1.3	3.4	2.0	3.8	3.0	10.7	0.4	1.6	10.5
14	SCE/SoCalGas	3.1	0.7	1.2	3.3	2.0	3.0	3.0	9.6	1.1	1.4	9.5
14	SDG&E	3.1	0.9	1.2	3.3	2.5	3.0	3.0	9.6	0.5	1.4	9.5
15	SCE/SoCalGas	4.2	1.4	2.3	4.4	>1	>1	4.0	8.8	1.3	1.7	8.5
16	PG&E	2.4	1.1	1.2	2.9	1.8	2.1	2.0	9.9	0.5	1.3	9.5

<sup>1</sup>">1" indicates cases where there are both first cost savings and annual utility bill savings.

<sup>2</sup>Information about the measures included for each climate zone are described in Appendix F – Multifamily Measure Summary.



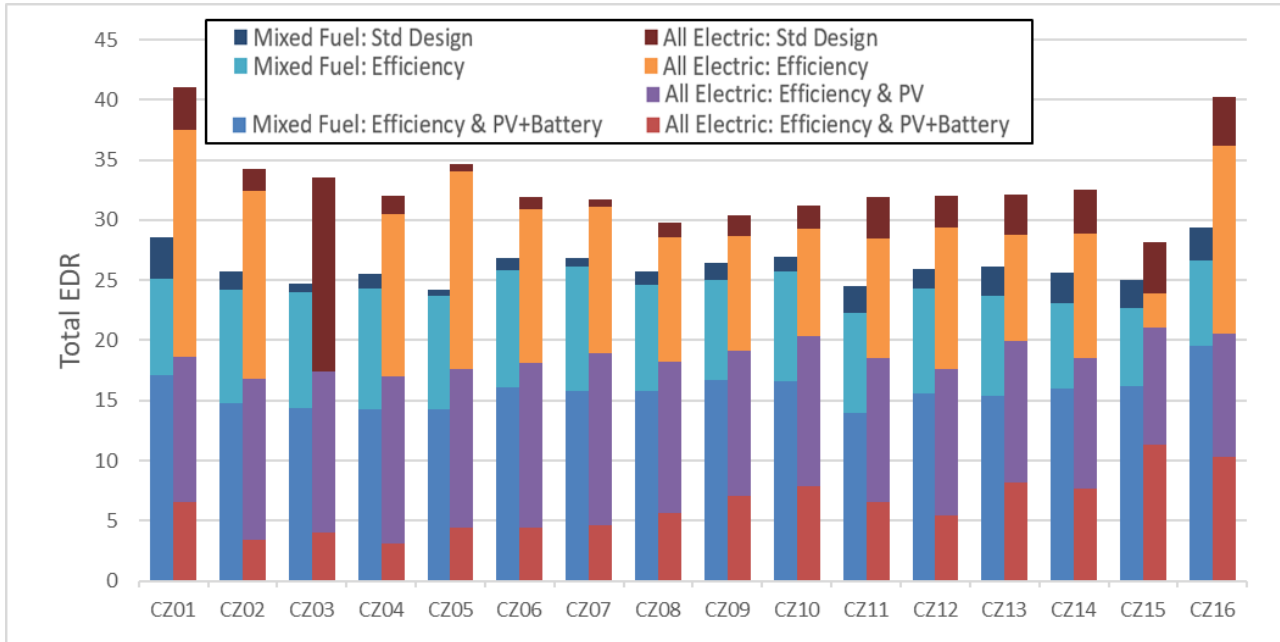
Table 13: Multifamily Package Cost-effectiveness Results for the All-Electric Case<sup>1,2</sup>

CZ	Utility	Efficiency							Efficiency & PV				Efficiency & PV/Battery			
		Non-Preempted			Equipment - Preempted			Target Efficiency EDR Margin	Total EDR Margin	On-Bill B/C Ratio	TDV B/C Ratio	Target Total EDR Margin	Total EDR Margin	On-Bill B/C Ratio	TDV B/C Ratio	Target Total EDR Margin
		Efficiency EDR Margin	On-Bill B/C Ratio	TDV B/C Ratio	Efficiency EDR Margin	On-Bill B/C Ratio	TDV B/C Ratio									
01	PG&E	3.6	1.6	1.4	3.3	2.4	2.3	3.0	22.5	2.0	1.5	22.5	34.5	1.3	1.4	34.5
02	PG&E	1.9	1.7	2.1	3.2	1.6	1.6	1.5	17.5	2.4	1.8	17.5	30.9	1.4	1.7	30.5
03	PG&E	0.0	-	-	2.7	1.7	1.6	0.0	16.1	2.4	1.7	16.0	29.5	1.3	1.6	29.5
04	PG&E	1.4	1.4	1.5	2.2	1.2	1.1	1.0	15.0	2.4	1.8	15.0	28.9	1.3	1.8	28.5
05	PG&E	0.6	1.1	0.9	3.6	2.1	2.0	0.5	17.1	2.5	1.8	17.0	30.3	1.4	1.7	30.0
05	PG&E/SoCalGas	0.6	1.1	0.9	3.6	2.1	2.0	0.5	17.1	2.5	1.8	17.0	30.3	1.4	1.7	30.0
06	SCE/SoCalGas	1.0	0.7	1.3	2.2	1.6	1.9	1.0	13.8	1.2	1.7	13.5	27.5	1.2	1.6	27.5
07	SDG&E	0.6	0.6	1.0	1.9	1.6	1.7	0.5	12.8	2.1	1.8	12.5	27.1	1.2	1.6	27.0
08	SCE/SoCalGas	1.2	0.9	1.7	1.9	1.6	1.8	1.0	11.6	1.3	1.8	11.5	24.2	1.2	1.6	24.0
09	SCE/SoCalGas	1.6	1.3	2.7	1.5	1.6	1.6	1.5	11.3	1.3	1.9	11.0	23.3	1.3	1.7	23.0
10	SCE/SoCalGas	1.8	1.2	2.0	1.8	1.7	2.0	1.5	10.8	1.3	1.8	10.5	23.3	1.3	1.7	23.0
10	SDG&E	1.8	1.5	2.0	1.8	2.0	2.0	1.5	10.8	2.1	1.8	10.5	23.3	1.4	1.7	23.0
11	PG&E	3.5	1.4	1.6	3.9	2.0	2.3	3.5	13.4	2.2	1.8	13.0	25.3	1.4	1.8	25.0
12	PG&E	2.6	0.9	1.1	2.9	1.6	1.6	2.5	14.4	2.1	1.6	14.0	26.6	1.3	1.7	26.5
13	PG&E	3.3	1.3	1.6	3.8	2.0	2.3	3.0	12.2	2.1	1.7	12.0	23.9	1.4	1.7	23.5
14	SCE/SoCalGas	3.7	1.2	1.6	3.8	1.6	2.2	3.5	14.0	1.4	1.9	14.0	24.8	1.4	1.8	24.5
14	SDG&E	3.7	1.5	1.6	3.8	2.0	2.2	3.5	14.0	2.2	1.9	14.0	24.8	1.7	1.8	24.5
15	SCE/SoCalGas	4.4	1.5	2.3	6.4	1.2	1.7	4.0	7.1	1.4	2.1	7.0	16.9	1.3	1.8	16.5
16	PG&E	4.1	2.1	2.1	3.2	1.6	1.7	3.0	19.6	2.6	1.9	19.5	29.9	1.6	1.7	29.5

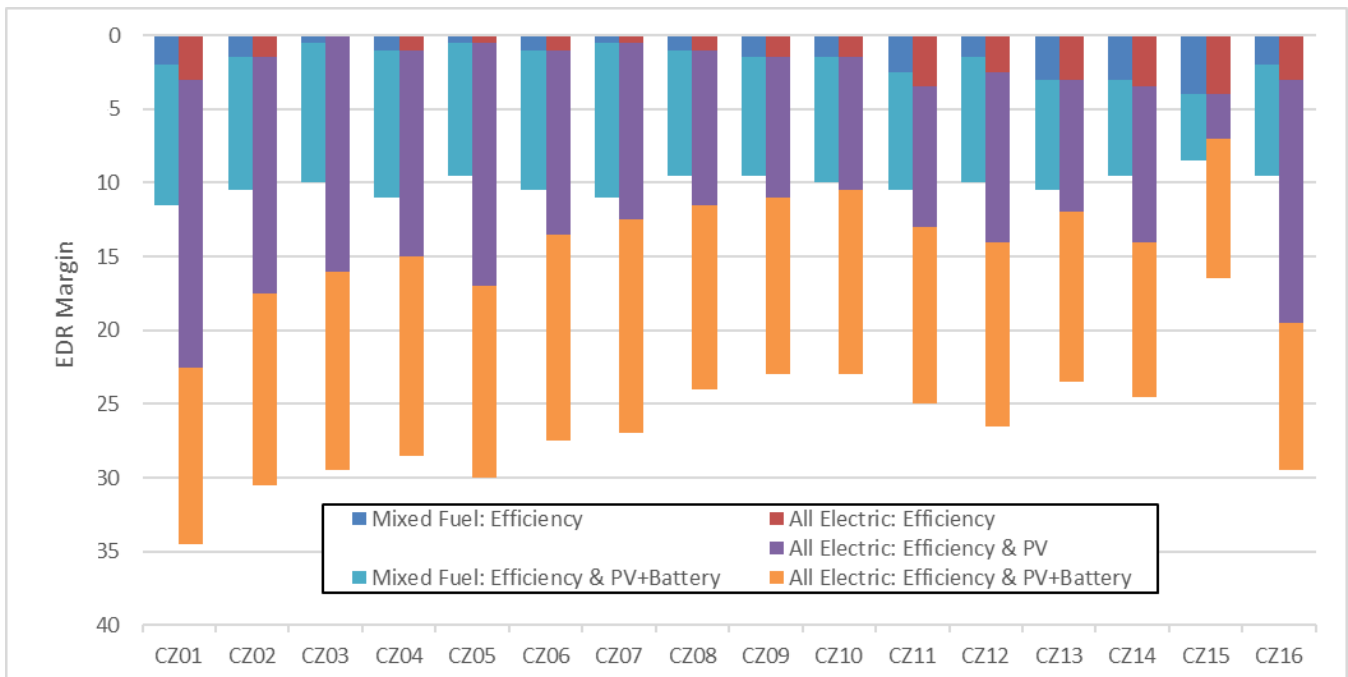
<sup>1</sup>">1" indicates cases where there are both first cost savings and annual utility bill savings.

<sup>2</sup>Information about the measures included for each climate zone are described in Appendix F – Multifamily Measure Summary.





**Figure 6: Multifamily Total EDR comparison**



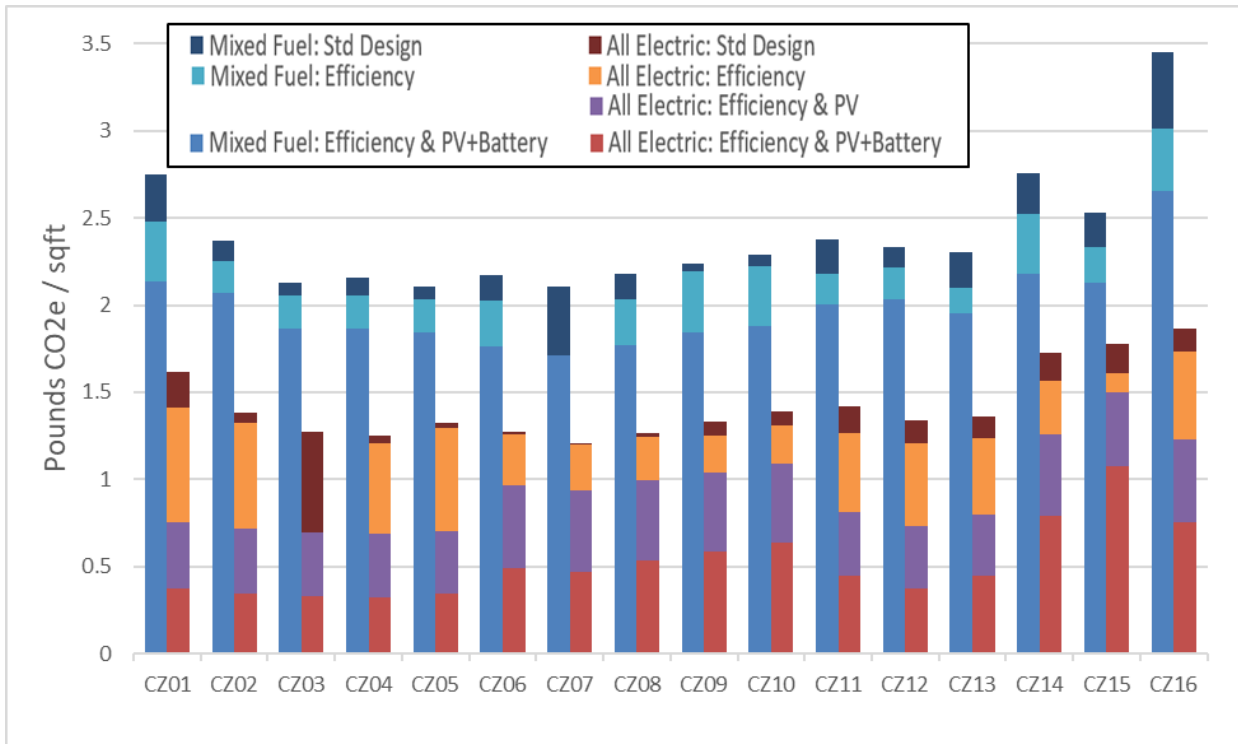
**Figure 7: Multifamily EDR Margin comparison (based on Efficiency EDR Margin for the Efficiency packages and the Total EDR Margin for the Efficiency & PV and Efficiency & PV/Battery packages)**





**3.3.1 GHG Emission Reductions**

Figure 8 compares annual GHG emissions for both mixed fuel and all-electric multifamily 2019 code compliant cases with Efficiency, Efficiency & PV and Efficiency & PV/Battery packages. GHG emissions vary by climate but are consistently higher in mixed fuel cases than all-electric. Standard design mixed fuel emissions range from 2.0 to 3.0 lbs CO<sub>2</sub>e/square foot of floor area, where all-electric standard design emissions range from 1.2 to 1.7 lbs CO<sub>2</sub>e/ ft<sup>2</sup>. Adding PV, batteries and efficiency to the mixed fuel code compliant prototype reduces annual GHG emissions by 17% on average to between 1.7 and 2.2 lbs CO<sub>2</sub>e/ft<sup>2</sup>, except Climate Zone 16. Adding PV, batteries and efficiency to the all-electric code compliant prototype reduces annual GHG emissions by 64% on average to 0.6 lbs CO<sub>2</sub>e/ft<sup>2</sup> or less with the exception of Climate Zones 14, 15 and 16. As in the single family case, none of the cases completely eliminate GHG emissions because of the time value of emissions calculation for electricity in CBECC-Res.



**Figure 8: Multifamily greenhouse gas emissions comparison**

**3.4 Electrification Results**

Cost-effectiveness results comparing mixed fuel and all-electric cases are summarized below. The tables show average annual utility bill impacts and lifetime utility bill impacts, which account for fuel escalation for electricity and natural gas (see Section 2.5), lifetime equipment cost savings, and both On-Bill and TDV cost-effectiveness (B/C ratio). Positive utility bill values indicate lower utility costs for the all-electric home relative to the mixed fuel case while negative values in red and parenthesis indicate higher utility costs for the all-electric case. Lifetime equipment cost savings include savings due to eliminating natural gas infrastructure and replacement costs for appliances based on equipment life. Positive values for the lifetime equipment cost savings indicate lower installed costs for the all-electric and negative values indicate higher costs. B/C ratios 1.0 or greater indicate positive cost-effectiveness. Cases where the B/C ratio is indicated as “>1” refer to instances where there was incremental cost savings in addition to annual utility bill savings. In these cases, there is no cost associated with this upgrade and benefits are realized immediately.



Three scenarios were evaluated:

1. **2019 Code Compliant:** Compares a 2019 code compliant all-electric home with a 2019 code compliant mixed fuel home.
2. **Efficiency & PV Package:** Compares an all-electric home with efficiency and PV sized to 90% of the annual electricity use to a 2019 code compliant mixed fuel home. The first cost savings in the code compliant all-electric house is invested in above code efficiency and PV reflective of the Efficiency & PV packages described above.
3. **Neutral Cost Package:** Compares an all-electric home with PV beyond code minimum with a 2019 code compliant mixed fuel home. The PV system for the all-electric case is sized to result in a zero lifetime incremental cost relative to a mixed fuel home.

### ***3.4.1 Single Family***

Table 14, Table 15, Figure 9, Figure 10, and Figure 11 present results of cost-effectiveness analysis for electrification of single family buildings, according to both the On-Bill and TDV methodologies. Based on typical cost assumptions arrived at for this analysis, the lifetime equipment costs for the single family code compliant all-electric option are approximately \$5,350 less than the mixed fuel code compliant option. Cost savings are entirely due to the elimination of gas infrastructure, which was assumed to be a savings of \$5,750. When evaluating cost-effectiveness based on TDV, the Utility Gas Main Extensions rules 50% refund and appliance allowance deduction are not applied and therefore the cost savings are twice as much.

Under the Efficiency & PV Package and the On-Bill analysis, the incremental cost of the efficiency and PV is typically more than the cost savings seen in the code compliant case, which results in a net cost increase in most climate zones for the all-electric case. In climates with small heating loads (7 and 15) there continues to be an incremental cost savings for the all-electric home. With the TDV analysis, there is still an incremental cost savings in all climates except 1 and 16 for single family.

Utility impacts differ by climate zone and utility, but utility costs for the code compliant all-electric option are typically higher than for the compliant mixed fuel design. There are utility cost savings across all climate zones and building types for the all-electric Efficiency & PV Package, resulting in a more cost-effective option.

The all-electric code compliant option is cost-effective based on the On-Bill approach for single family homes in Climate Zones 6 through 9, 10 (SCE/SoCalGas territory only), and 15. The code compliant option is cost-effective based on the TDV methodology in all climate zones except 1 and 16. If the same costs used for the On-Bill approach are also used for the TDV approach (incorporating the Utility Gas Main Extensions rules 50% refund and appliance allowance deduction), the all-electric code compliant option is cost-effective in Climate Zones 6 through 10. The Efficiency & PV all-electric option is cost-effective in all climate zones based on both the On-Bill and TDV methodologies. In many cases it is cost-effective immediately with lower equipment and utility costs.

The last set of results in Table 14 shows the neutral cost case where the cost savings for the all-electric code compliant home is invested in a larger PV system, resulting in a lifetime incremental cost of zero based on the On-Bill approach. This package results in utility cost savings in all cases except Climate Zones 1, 14 (SCE/SoCalGas territory only), and 16. For these three cases the Reach Code Team evaluated how much additional PV would be required to result in a cost-effective package. These results are presented in Table 15 and show that an additional 1.6kW in Climate Zone 1 results in a B/C ratio of 1.1. For Climate Zone 14 and 16 adding 0.25kW and 1.2kW, respectively, results in a B/C ratio of 1.2. Neutral cost cases are cost-effective based on the TDV methodology in all climate zones except 16.

### ***3.4.2 Multifamily***

Multifamily results are found in Table 16, Table 17, Figure 12, Figure 13, and Figure 14. Lifetime costs for the multifamily code compliant all-electric option are approximately \$2,300 less than the mixed fuel code compliant option, entirely due to the elimination of gas infrastructure. When evaluating cost-effectiveness based on TDV,



the Utility Gas Main Extensions rules 50% refund and appliance allowance deduction are not applied and therefore the cost savings are approximately 2.5 times higher.

With the Efficiency & PV Package and the On-Bill analysis, due to the added cost of the efficiency and PV there is a net cost increase for the all-electric case in all climate zones for except 7, 8, 9, and 15. With the TDV analysis, there is still an incremental cost savings in all climates. Like the single family results, utility costs are typically higher for the code compliant all-electric option but lower than the code compliant mixed fuel option with the Efficiency & PV Package.

The all-electric code compliant option is cost-effective based on the On-Bill approach for multifamily in Climate Zones 6 through 9, 10 and 14 (SCE/SoCalGas territory only), and 15. Based on the TDV methodology, the code compliant option for multifamily is cost-effective for all climate zones. If the same costs used for the On-Bill approach are also used for the TDV approach (incorporating the Utility Gas Main Extensions rules 50% refund and appliance allowance deduction), the all-electric code compliant option is cost-effective in Climate Zones 8 and 9. Like the single family cases, the Efficiency & PV all-electric option is cost-effective in all climate zones based on both the On-Bill and TDV methodologies.

The last set of results in Table 16 show the neutral cost case where the cost savings for the all-electric code compliant home is invested in a larger PV system, resulting in a lifetime incremental cost of zero based on the On-Bill approach. This package results in utility cost savings in all cases except Climate Zone 1. For this case the Reach Code Team evaluated how much additional PV would be required to result in a cost-effective package. These results are presented in Table 17 and show that an additional 0.3kW per apartment results in a B/C ratio of 1.1. Neutral cost cases are cost-effective based on the TDV methodology in all climate zones except 16.

**Table 14: Single Family Electrification Results**

CZ	Utility	On-Bill Cost-effectiveness <sup>1</sup>						TDV Cost-effectiveness		
		Average Annual Utility Bill Savings			Lifetime NPV			Lifetime NPV		
		Electricity	Natural Gas	Net Utility Savings	Utility Bill Savings	Equipment Cost Savings	On-Bill B/C Ratio <sup>2</sup>	TDV Cost Savings	Equipment Cost Savings	TDV B/C Ratio
<b>2019 Code Compliant Home</b>										
01	PG&E	-\$1,194	+\$712	-\$482	-\$14,464	+\$5,349	0.4	-\$13,081	+\$11,872	0.9
02	PG&E	-\$825	+\$486	-\$340	-\$10,194	+\$5,349	0.5	-\$7,456	+\$11,872	1.6
03	PG&E	-\$717	+\$391	-\$326	-\$9,779	+\$5,349	0.5	-\$7,766	+\$11,872	1.5
04	PG&E	-\$710	+\$387	-\$322	-\$9,671	+\$5,349	0.6	-\$7,447	+\$11,872	1.6
05	PG&E	-\$738	+\$367	-\$371	-\$11,128	+\$5,349	0.5	-\$8,969	+\$11,872	1.3
05	PG&E/SoCalGas	-\$738	+\$370	-\$368	-\$11,034	+\$5,349	0.5	-\$8,969	+\$11,872	1.3
06	SCE/SoCalGas	-\$439	+\$289	-\$149	-\$4,476	+\$5,349	1.2	-\$4,826	+\$11,872	2.5
07	SDG&E	-\$414	+\$243	-\$171	-\$5,134	+\$5,349	1.0	-\$4,678	+\$11,872	2.5
08	SCE/SoCalGas	-\$347	+\$249	-\$97	-\$2,921	+\$5,349	1.8	-\$3,971	+\$11,872	3.0
09	SCE/SoCalGas	-\$377	+\$271	-\$107	-\$3,199	+\$5,349	1.7	-\$4,089	+\$11,872	2.9
10	SCE/SoCalGas	-\$403	+\$280	-\$123	-\$3,684	+\$5,349	1.5	-\$4,458	+\$11,872	2.7
10	SDG&E	-\$496	+\$297	-\$198	-\$5,950	+\$5,349	0.9	-\$4,458	+\$11,872	2.7
11	PG&E	-\$810	+\$447	-\$364	-\$10,917	+\$5,349	0.5	-\$7,024	+\$11,872	1.7
12	PG&E	-\$740	+\$456	-\$284	-\$8,533	+\$5,349	0.6	-\$6,281	+\$11,872	1.9
13	PG&E	-\$742	+\$413	-\$329	-\$9,870	+\$5,349	0.5	-\$6,480	+\$11,872	1.8
14	SCE/SoCalGas	-\$661	+\$413	-\$248	-\$7,454	+\$5,349	0.7	-\$7,126	+\$11,872	1.7
14	SDG&E	-\$765	+\$469	-\$296	-\$8,868	+\$5,349	0.6	-\$7,126	+\$11,872	1.7
15	SCE/SoCalGas	-\$297	+\$194	-\$103	-\$3,090	+\$5,349	1.7	-\$5,364	+\$11,872	2.2
16	PG&E	-\$1,287	+\$712	-\$575	-\$17,250	+\$5,349	0.3	-\$17,391	+\$11,872	0.7



CZ	Utility	On-Bill Cost-effectiveness <sup>1</sup>						TDV Cost-effectiveness		
		Average Annual Utility Bill Savings			Lifetime NPV			Lifetime NPV		
		Electricity	Natural Gas	Net Utility Savings	Utility Bill Savings	Equipment Cost Savings	On-Bill B/C Ratio <sup>2</sup>	TDV Cost Savings	Equipment Cost Savings	TDV B/C Ratio
<b>Efficiency &amp; PV Package</b>										
01	PG&E	-\$99	+\$712	+\$613	+\$18,398	-\$12,844	1.4	+\$13,364	-\$6,321	2.1
02	PG&E	-\$89	+\$486	+\$397	+\$11,910	-\$6,758	1.8	+\$9,307	-\$234	39.7
03	PG&E	-\$87	+\$391	+\$304	+\$9,119	-\$3,169	2.9	+\$6,516	+\$3,355	>1
04	PG&E	-\$85	+\$387	+\$302	+\$9,074	-\$3,438	2.6	+\$6,804	+\$3,086	>1
05	PG&E	-\$98	+\$367	+\$268	+\$8,054	-\$2,959	2.7	+\$5,625	+\$3,564	>1
05	PG&E/SoCalGas	-\$98	+\$370	+\$272	+\$8,148	-\$2,959	2.8	+\$5,625	+\$3,564	>1
06	SCE/SoCalGas	-\$188	+\$289	+\$102	+\$3,049	-\$992	3.1	+\$4,585	+\$5,531	>1
07	SDG&E	-\$137	+\$243	+\$106	+\$3,174	+\$912	>1	+\$2,176	+\$7,436	>1
08	SCE/SoCalGas	-\$160	+\$249	+\$89	+\$2,664	-\$25	107.9	+\$3,965	+\$6,499	>1
09	SCE/SoCalGas	-\$169	+\$271	+\$102	+\$3,067	-\$429	7.1	+\$5,368	+\$6,094	>1
10	SCE/SoCalGas	-\$173	+\$280	+\$107	+\$3,216	-\$1,057	3.0	+\$5,165	+\$5,466	>1
10	SDG&E	-\$137	+\$297	+\$160	+\$4,805	-\$1,057	4.5	+\$5,165	+\$5,466	>1
11	PG&E	-\$147	+\$447	+\$300	+\$8,988	-\$5,478	1.6	+\$9,776	+\$1,045	>1
12	PG&E	-\$92	+\$456	+\$364	+\$10,918	-\$6,172	1.8	+\$9,913	+\$352	>1
13	PG&E	-\$144	+\$413	+\$269	+\$8,077	-\$5,184	1.6	+\$8,960	+\$1,339	>1
14	SCE/SoCalGas	-\$241	+\$413	+\$172	+\$5,164	-\$5,111	1.0	+\$9,850	+\$1,412	>1
14	SDG&E	-\$139	+\$469	+\$330	+\$9,910	-\$5,111	1.9	+\$9,850	+\$1,412	>1
15	SCE/SoCalGas	-\$107	+\$194	+\$87	+\$2,603	+\$264	>1	+\$2,598	+\$6,787	>1
16	PG&E	-\$130	+\$712	+\$582	+\$17,457	-\$11,234	1.6	+\$9,536	-\$4,710	2.0
<b>Neutral Cost Package</b>										
01	PG&E	-\$869	+\$712	-\$157	-\$4,704	+\$0	0	-\$6,033	+\$6,549	1.1
02	PG&E	-\$445	+\$486	+\$40	+\$1,213	+\$0	>1	+\$868	+\$6,505	>1
03	PG&E	-\$335	+\$391	+\$56	+\$1,671	+\$0	>1	+\$483	+\$6,520	>1
04	PG&E	-\$321	+\$387	+\$66	+\$1,984	+\$0	>1	+\$1,062	+\$6,521	>1
05	PG&E	-\$335	+\$367	+\$31	+\$938	+\$0	>1	-\$163	+\$6,519	40.1
05	PG&E/SoCalGas	-\$335	+\$370	+\$34	+\$1,031	+\$0	>1	-\$163	+\$6,519	40.1
06	SCE/SoCalGas	-\$227	+\$289	+\$63	+\$1,886	+\$0	>1	+\$3,258	+\$6,499	>1
07	SDG&E	-\$72	+\$243	+\$171	+\$5,132	+\$0	>1	+\$3,741	+\$6,519	>1
08	SCE/SoCalGas	-\$144	+\$249	+\$105	+\$3,162	+\$0	>1	+\$4,252	+\$6,515	>1
09	SCE/SoCalGas	-\$170	+\$271	+\$100	+\$3,014	+\$0	>1	+\$4,271	+\$6,513	>1
10	SCE/SoCalGas	-\$199	+\$280	+\$81	+\$2,440	+\$0	>1	+\$3,629	+\$6,494	>1
10	SDG&E	-\$155	+\$297	+\$143	+\$4,287	+\$0	>1	+\$3,629	+\$6,494	>1
11	PG&E	-\$426	+\$447	+\$21	+\$630	+\$0	>1	+\$1,623	+\$6,504	>1
12	PG&E	-\$362	+\$456	+\$94	+\$2,828	+\$0	>1	+\$2,196	+\$6,525	>1
13	PG&E	-\$370	+\$413	+\$43	+\$1,280	+\$0	>1	+\$1,677	+\$6,509	>1
14	SCE/SoCalGas	-\$416	+\$413	-\$4	-\$107	+\$0	0	+\$2,198	+\$6,520	>1
14	SDG&E	-\$391	+\$469	+\$79	+\$2,356	+\$0	>1	+\$2,198	+\$6,520	>1
15	SCE/SoCalGas	-\$98	+\$194	+\$97	+\$2,900	+\$0	>1	+\$2,456	+\$6,483	>1
16	PG&E	-\$878	+\$712	-\$166	-\$4,969	+\$0	0	-\$8,805	+\$6,529	0.7

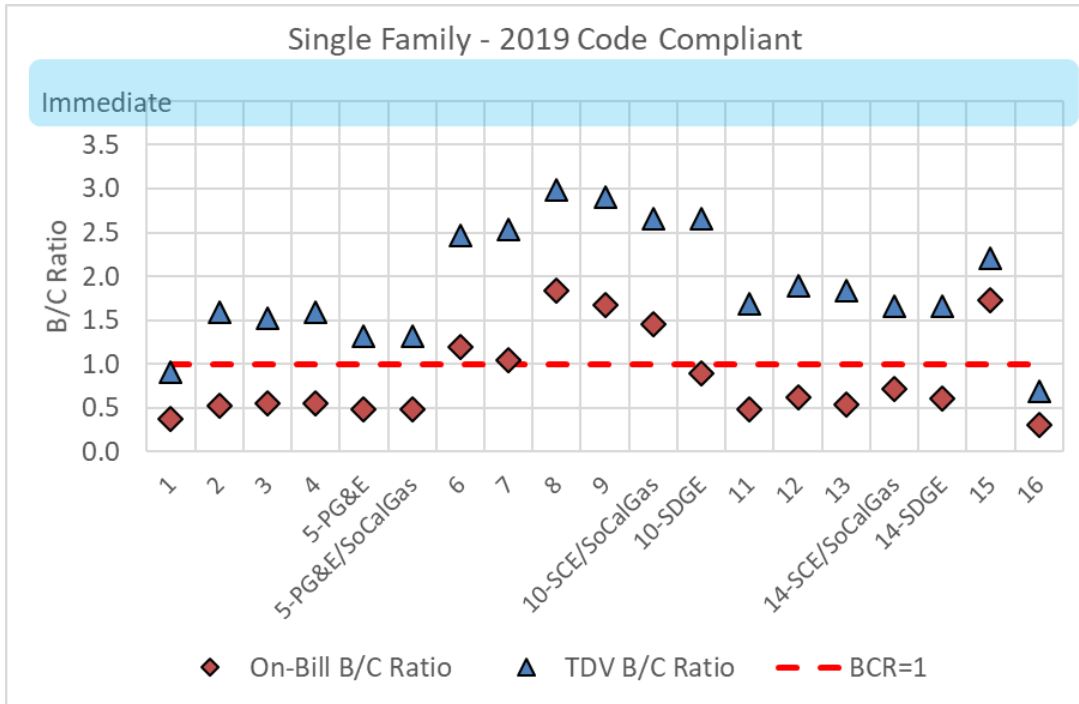
<sup>1</sup>Red values in parentheses indicate an increase in utility bill costs or an incremental first cost for the all-electric home.

<sup>2</sup>>1" indicates cases where there are both first cost savings and annual utility bill savings.



**Table 15: Comparison of Single Family On-Bill Cost Effectiveness Results with Additional PV**

CZ	Utility	Neutral Cost				Min. Cost Effectiveness			
		PV Capacity (kW)	Utility Bill Savings	Equipment Cost Savings	On-Bill B/C Ratio	PV Capacity (kW)	Utility Bill Savings	Equipment Cost Savings	On-Bill B/C Ratio
01	PG&E	4.7	-\$4,704	+\$0	0	6.3	+\$6,898	-\$6,372	1.1
14	SCE/SoCalGas	4.5	-\$107	+\$0	0	4.8	+\$1,238	-\$1,000	1.2
16	PG&E	4.1	-\$4,969	+\$0	0	5.3	+\$5,883	-\$4,753	1.2



**Figure 9: B/C ratio results for a single family all-electric code compliant home versus a mixed fuel code compliant home**



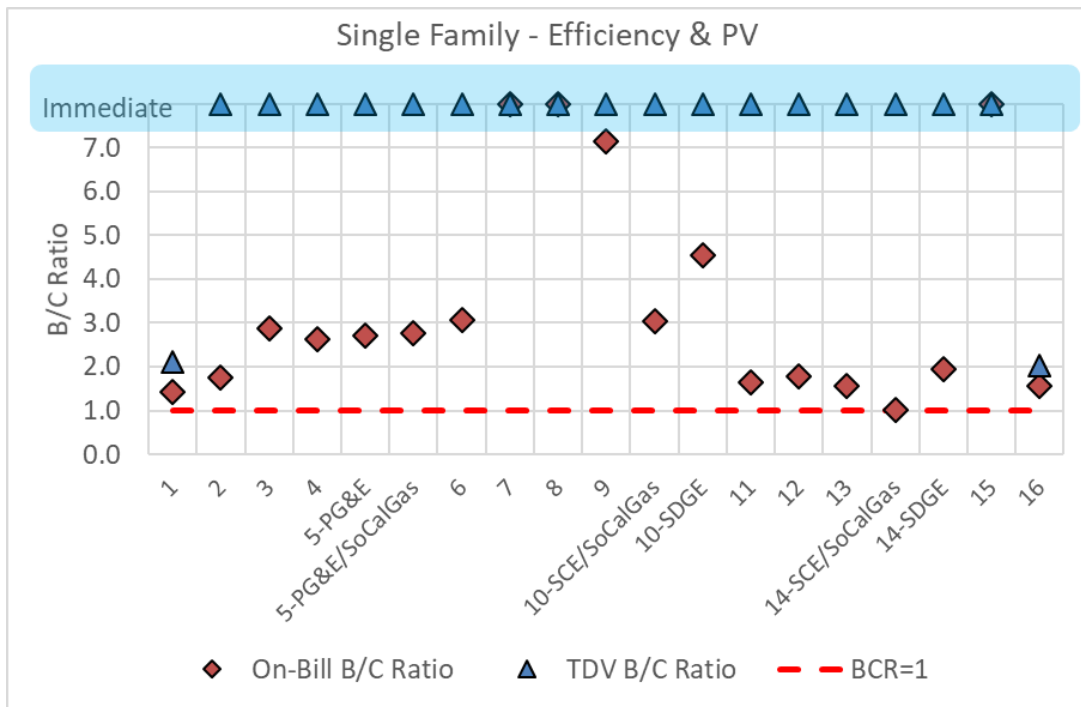


Figure 10: B/C ratio results for the single family Efficiency & PV all-electric home versus a mixed fuel code compliant home

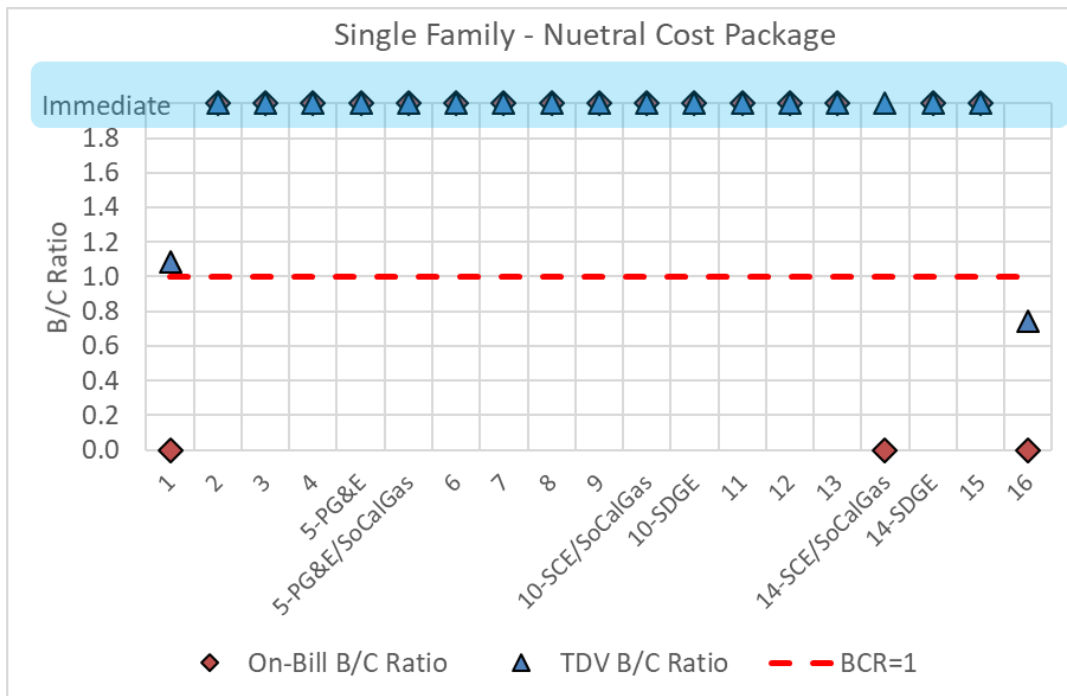


Figure 11: B/C ratio results for the single family neutral cost package all-electric home versus a mixed fuel code compliant home



Table 16: Multifamily Electrification Results (Per Dwelling Unit)

CZ	Utility	On-Bill Cost-effectiveness <sup>1</sup>						TDV Cost-effectiveness		
		Average Annual Utility Bill Savings			Lifetime NPV			Lifetime NPV		
		Electricity	Natural Gas	Net Utility Savings	Utility Bill Savings	Equipment Cost Savings	On-Bill B/C Ratio <sup>2</sup>	TDV Cost Savings	Equipment Cost Savings	TDV B/C Ratio
<b>2019 Code Compliant Home</b>										
01	PG&E	-\$396	+\$193	-\$203	-\$6,079	+\$2,337	0.4	-\$5,838	+\$5,899	1.0
02	PG&E	-\$310	+\$162	-\$148	-\$4,450	+\$2,337	0.5	-\$4,144	+\$5,899	1.4
03	PG&E	-\$277	+\$142	-\$135	-\$4,041	+\$2,337	0.6	-\$4,035	+\$5,899	1.5
04	PG&E	-\$264	+\$144	-\$120	-\$3,595	+\$2,337	0.6	-\$3,329	+\$5,899	1.8
05	PG&E	-\$297	+\$140	-\$157	-\$4,703	+\$2,337	0.5	-\$4,604	+\$5,899	1.3
05	PG&E/SoCalGas	-\$297	+\$178	-\$119	-\$3,573	+\$2,337	0.7	-\$4,604	+\$5,899	1.3
06	SCE/SoCalGas	-\$191	+\$161	-\$30	-\$902	+\$2,337	2.6	-\$2,477	+\$5,899	2.4
07	SDG&E	-\$206	+\$136	-\$70	-\$2,094	+\$2,337	1.1	-\$2,390	+\$5,899	2.5
08	SCE/SoCalGas	-\$169	+\$157	-\$12	-\$349	+\$2,337	6.7	-\$2,211	+\$5,899	2.7
09	SCE/SoCalGas	-\$177	+\$159	-\$18	-\$533	+\$2,337	4.4	-\$2,315	+\$5,899	2.5
10	SCE/SoCalGas	-\$183	+\$159	-\$23	-\$697	+\$2,337	3.4	-\$2,495	+\$5,899	2.4
10	SDG&E	-\$245	+\$139	-\$106	-\$3,192	+\$2,337	0.7	-\$2,495	+\$5,899	2.4
11	PG&E	-\$291	+\$153	-\$138	-\$4,149	+\$2,337	0.6	-\$4,420	+\$5,899	1.3
12	PG&E	-\$277	+\$155	-\$122	-\$3,665	+\$2,337	0.6	-\$3,557	+\$5,899	1.7
13	PG&E	-\$270	+\$146	-\$124	-\$3,707	+\$2,337	0.6	-\$3,821	+\$5,899	1.5
14	SCE/SoCalGas	-\$255	+\$187	-\$69	-\$2,062	+\$2,337	1.1	-\$3,976	+\$5,899	1.5
14	SDG&E	-\$328	+\$175	-\$154	-\$4,607	+\$2,337	0.5	-\$3,976	+\$5,899	1.5
15	SCE/SoCalGas	-\$154	+\$142	-\$12	-\$367	+\$2,337	6.4	-\$2,509	+\$5,899	2.4
16	PG&E	-\$404	+\$224	-\$180	-\$5,411	+\$2,337	0.4	-\$5,719	+\$5,899	1.0
<b>Efficiency &amp; PV Package</b>										
01	PG&E	-\$19	+\$193	+\$174	+\$5,230	-\$3,202	1.6	+\$2,467	+\$361	>1
02	PG&E	-\$10	+\$162	+\$152	+\$4,549	-\$1,375	3.3	+\$2,605	+\$2,187	>1
03	PG&E	-\$12	+\$142	+\$130	+\$3,910	-\$936	4.2	+\$1,632	+\$2,626	>1
04	PG&E	-\$8	+\$144	+\$136	+\$4,080	-\$822	5.0	+\$2,381	+\$2,740	>1
05	PG&E	-\$19	+\$140	+\$121	+\$3,635	-\$956	3.8	+\$1,403	+\$2,606	>1
05	PG&E/SoCalGas	-\$19	+\$178	+\$159	+\$4,765	-\$956	5.0	+\$1,403	+\$2,606	>1
06	SCE/SoCalGas	-\$84	+\$161	+\$77	+\$2,309	-\$243	9.5	+\$1,940	+\$3,319	>1
07	SDG&E	-\$49	+\$136	+\$87	+\$2,611	+\$75	>1	+\$1,583	+\$3,638	>1
08	SCE/SoCalGas	-\$74	+\$157	+\$83	+\$2,480	+\$96	>1	+\$1,772	+\$3,658	>1
09	SCE/SoCalGas	-\$76	+\$159	+\$82	+\$2,469	+\$104	>1	+\$1,939	+\$3,667	>1
10	SCE/SoCalGas	-\$79	+\$159	+\$80	+\$2,411	-\$34	70.9	+\$1,737	+\$3,528	>1
10	SDG&E	-\$77	+\$139	+\$61	+\$1,842	-\$34	54.2	+\$1,737	+\$3,528	>1
11	PG&E	-\$25	+\$153	+\$128	+\$3,834	-\$1,264	3.0	+\$2,080	+\$2,298	>1
12	PG&E	-\$11	+\$155	+\$144	+\$4,316	-\$1,498	2.9	+\$2,759	+\$2,064	>1
13	PG&E	-\$26	+\$146	+\$121	+\$3,625	-\$1,125	3.2	+\$2,083	+\$2,437	>1
14	SCE/SoCalGas	-\$99	+\$187	+\$87	+\$2,616	-\$1,019	2.6	+\$2,422	+\$2,543	>1
14	SDG&E	-\$86	+\$175	+\$88	+\$2,647	-\$1,019	2.6	+\$2,422	+\$2,543	>1
15	SCE/SoCalGas	-\$67	+\$142	+\$75	+\$2,247	+\$511	>1	+\$1,276	+\$4,073	>1
16	PG&E	-\$24	+\$224	+\$200	+\$5,992	-\$2,087	2.9	+\$2,629	+\$1,476	>1



CZ	Utility	On-Bill Cost-effectiveness <sup>1</sup>						TDV Cost-effectiveness		
		Average Annual Utility Bill Savings			Lifetime NPV			Lifetime NPV		
		Electricity	Natural Gas	Net Utility Savings	Utility Bill Savings	Equipment Cost Savings	On-Bill B/C Ratio <sup>2</sup>	TDV Cost Savings	Equipment Cost Savings	TDV B/C Ratio
<b>Neutral Cost Package</b>										
01	PG&E	-\$228	+\$193	-\$35	-\$1,057	+\$0	0	-\$2,267	+\$3,564	1.6
02	PG&E	-\$115	+\$162	+\$47	+\$1,399	+\$0	>1	+\$59	+\$3,563	>1
03	PG&E	-\$81	+\$142	+\$61	+\$1,843	+\$0	>1	+\$138	+\$3,562	>1
04	PG&E	-\$64	+\$144	+\$80	+\$2,402	+\$0	>1	+\$983	+\$3,563	>1
05	PG&E	-\$90	+\$140	+\$50	+\$1,490	+\$0	>1	-\$152	+\$3,564	23.4
05	PG&E/SoCalGas	-\$90	+\$178	+\$87	+\$2,620	+\$0	>1	-\$152	+\$3,564	23.4
06	SCE/SoCalGas	-\$90	+\$161	+\$71	+\$2,144	+\$0	>1	+\$1,612	+\$3,562	>1
07	SDG&E	-\$32	+\$136	+\$105	+\$3,135	+\$0	>1	+\$1,886	+\$3,560	>1
08	SCE/SoCalGas	-\$67	+\$157	+\$90	+\$2,705	+\$0	>1	+\$1,955	+\$3,564	>1
09	SCE/SoCalGas	-\$71	+\$159	+\$87	+\$2,623	+\$0	>1	+\$1,924	+\$3,561	>1
10	SCE/SoCalGas	-\$78	+\$159	+\$81	+\$2,431	+\$0	>1	+\$1,588	+\$3,561	>1
10	SDG&E	-\$71	+\$139	+\$68	+\$2,033	+\$0	>1	+\$1,588	+\$3,561	>1
11	PG&E	-\$93	+\$153	+\$59	+\$1,783	+\$0	>1	-\$48	+\$3,562	74.0
12	PG&E	-\$82	+\$155	+\$73	+\$2,184	+\$0	>1	+\$739	+\$3,564	>1
13	PG&E	-\$79	+\$146	+\$68	+\$2,034	+\$0	>1	+\$310	+\$3,560	>1
14	SCE/SoCalGas	-\$141	+\$187	+\$45	+\$1,359	+\$0	>1	+\$747	+\$3,562	>1
14	SDG&E	-\$137	+\$175	+\$38	+\$1,131	+\$0	>1	+\$747	+\$3,562	>1
15	SCE/SoCalGas	-\$50	+\$142	+\$92	+\$2,771	+\$0	>1	+\$1,738	+\$3,560	>1
16	PG&E	-\$194	+\$224	+\$30	+\$900	+\$0	>1	-\$1,382	+\$3,564	2.6

<sup>1</sup>Red values in parentheses indicate an increase in utility bill costs or an incremental first cost for the all-electric home.

<sup>2</sup>">1" indicates cases where there are both first cost savings and annual utility bill savings.

**Table 17: Comparison of Multifamily On-Bill Cost Effectiveness Results with Additional PV (Per Dwelling Unit)**

CZ	Utility	Neutral Cost				Min. Cost Effectiveness			
		PV Capacity (kW)	Utility Bill Savings	Equipment Cost Savings	On-Bill B/C Ratio	PV Capacity (kW)	Utility Bill Savings	Equipment Cost Savings	On-Bill B/C Ratio
01	PG&E	2.7	-\$1,057	+\$0	0	3.0	+\$1,198	-\$1,052	1.1





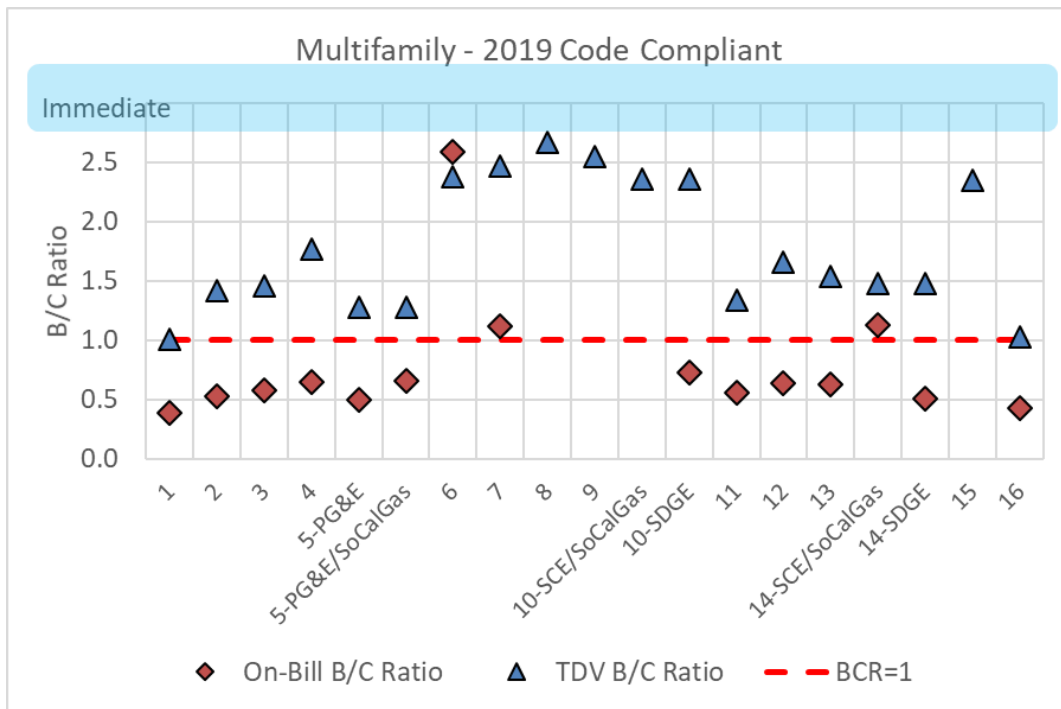


Figure 12: B/C ratio results for a multifamily all-electric code compliant home versus a mixed fuel code compliant home

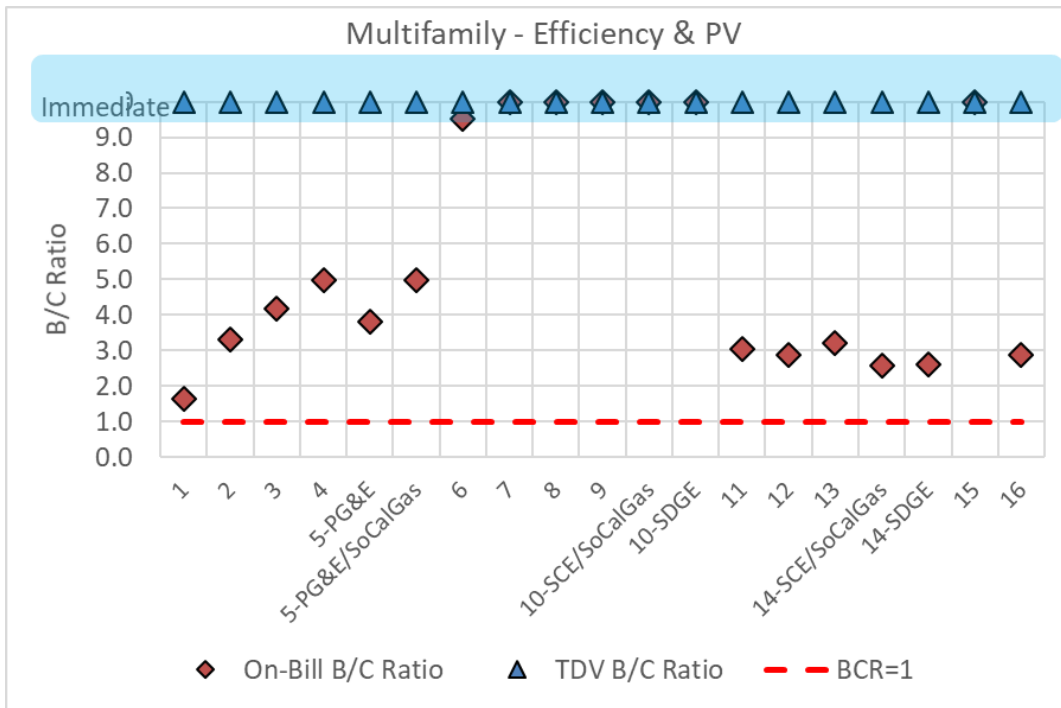
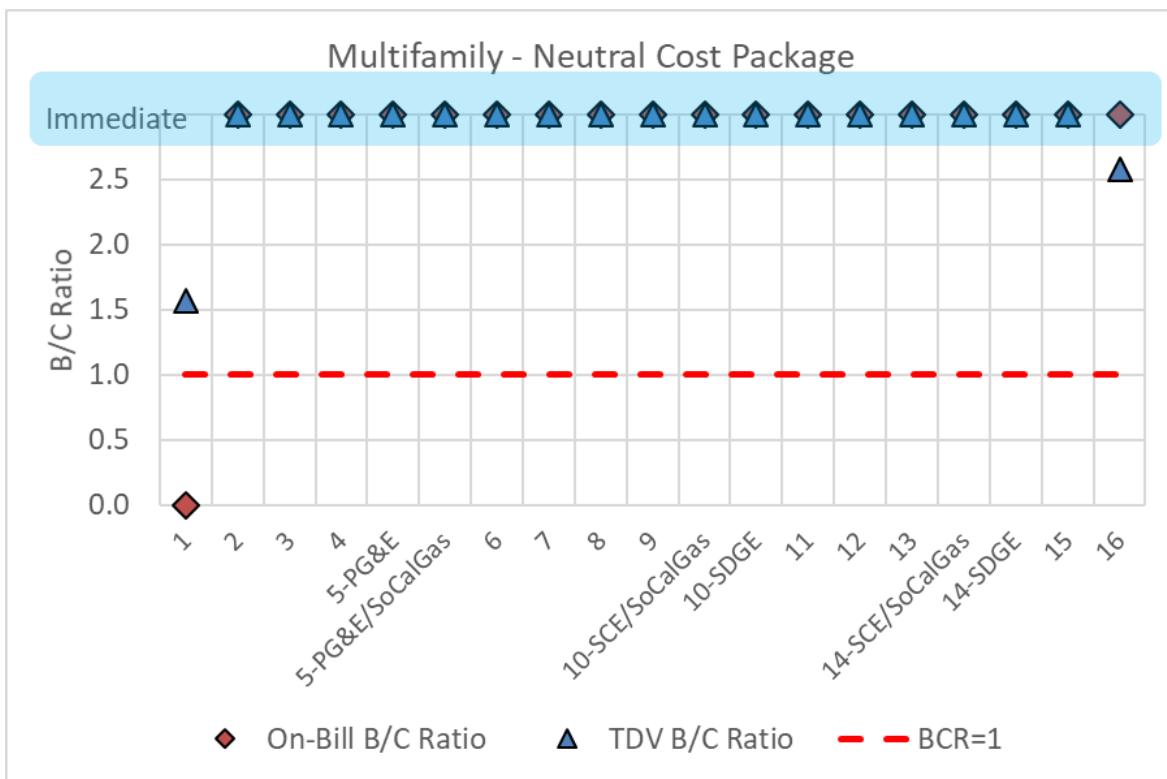


Figure 13: B/C ratio results for the multifamily Efficiency & PV all-electric home versus a mixed fuel code compliant home





**Figure 14: B/C ratio results for the multifamily neutral cost package all-electric home versus a mixed fuel code compliant home**

## 4 Conclusions & Summary

This report evaluated the feasibility and cost-effectiveness of “above code” performance specifications through the application of efficiency measures, PV, and electric battery storage in all 16 California climate zones. The analysis found cost-effective packages across the state for both single family and low-rise multifamily buildings. For the building types and climate zones where cost-effective packages were identified, the results of this analysis can be used by local jurisdictions to support the adoption of reach codes. Cost-effectiveness was evaluated according to two metrics: On-Bill customer lifecycle benefit-to-cost and TDV lifecycle benefit-to-cost. While all the above code targets presented are based on packages that are cost-effective under at least one of these metrics, they are not all cost-effective under both metrics. Generally, the test for being cost-effective under the TDV methodology is less challenging than under the On-Bill methodology. Therefore, all packages presented are cost-effective based on TDV, and may or may not be cost-effective based on the On-Bill method. It is up to each jurisdiction to determine what metric is most appropriate for their application. A summary of results by climate zone are presented in Appendix G – Results by Climate Zone.

Above code targets are presented as Target EDR Margin, which have been defined for each scenario where a cost-effective package was identified. Target EDR Margins represent the maximum “reach” values that meet the requirements. Jurisdictions may adopt less stringent requirements. For the Efficiency Package the Target EDR Margin was defined based on the lower EDR Margin of the Efficiency – Non-Preempted Package and the Efficiency – Equipment, Preempted Package. For example, if the cost-effective Non-Preempted package has an EDR Margin of 3 and the Preempted package an EDR Margin of 4, the Target EDR Margin is set at 3.

The average incremental cost for the single family Efficiency packages is ~\$1,750. The Efficiency & PV Package average incremental cost is \$9,180 and for the Efficiency & PV/Battery Package it is approximately \$5,600 for the



mixed fuel cases and \$15,100 for the all-electric cases. The incremental costs for each multifamily apartment are approximately 30-40% lower. See Table 8 and Table 11 for a summary of package costs by case.

Table 18 and Table 19 summarize the maximum Target EDR Margins determined to be cost effective for each package for single family and multifamily, respectively. Cases labeled as “n/a” in the tables indicate where no cost-effective package was identified under either On-Bill or TDV methodology.

This analysis also looked at the GHG emissions impacts of the various packages. An all-electric design reduces GHG emissions 40-50% in most cases relative to a comparable mixed fuel design.

There is significant interest throughout California on electrification of new buildings. The Reach Code Team assembled data on the cost differences between a code compliant mixed fuel building and a code compliant all-electric building. Based on lifetime equipment cost savings (the difference in first cost for equipment and infrastructure combined with incremental replacement costs) of \$5,349 for an all-electric single family home this analysis found that from a customer on-bill perspective, the all-electric code compliant option is cost-effective in Climates Zones 6 through 9, 10 (SCE/SoCalGas territory only), and 15, and cost-effective in all climate zones except 1 and 16 based on TDV. For multifamily buildings, based on a cost savings of \$2,337 per apartment, the code compliant option is cost-effective in Climates Zones 6 through 9, 10 & 14 (SCE/SoCalGas territory only), and 15, and cost-effective based on TDV.

Adding efficiency and PV to the code compliant all-electric buildings increases the cost-effectiveness in all climate zones. The Efficiency & PV Package is cost-effective when compared to a mixed fuel code compliant building in all climate zones for both single family and multifamily buildings based on both the On-Bill and TDV methodologies. The Efficiency & PV package adds PV to offset 90% of the electricity use of the home. While this results in higher installed costs, the reduced lifetime utility costs are larger (\$0 to \$6,000 lifetime incremental equipment costs in many climates for single family homes and an associated \$4,500 to \$13,500 lifetime utility cost savings across the same cases), resulting in positive B/C ratios for all cases.

The Reach Code Team also evaluated a neutral cost electrification scenario where the cost savings for the all-electric code compliant home is invested in a larger PV system, resulting in a lifetime incremental cost of zero based on the On-Bill approach. This package results in utility cost savings and positive on-bill B/C ratio in all cases except Climate Zones 1 and 16 for single family, and Climate Zone 1 for low-rise multifamily. Increasing the PV sizes in those climates by approximately 30% resulted in positive on-bill B/C ratios, while still not resulting in oversizing of PV systems.

Other studies have shown that cost-effectiveness of electrification increases with high efficiency space conditioning and water heating equipment in the all-electric home. This was not directly evaluated in this analysis but based on the favorable cost-effectiveness results of the Equipment, Preempted package for the individual mixed fuel and all-electric upgrades it's expected that applying similar packages to the electrification analysis would result in increased cost-effectiveness.

The Reach Code Team found there can be substantial variability in first costs, particularly related to natural gas infrastructure. Costs are project-dependent and will be impacted by such factors as site characteristics, distance to the nearest gas main, joint trenching, whether work is conducted by the utility or a private contractor, and number of homes per development among other things. While the best cost data available to the Reach Code Team was applied in this analysis, individual projects may experience different costs, either higher or lower than the estimates presented here.

**Table 18: Summary of Single Family Target EDR Margins**

Climate Zone	Mixed Fuel		All-Electric		
	Efficiency	Efficiency & PV/Battery	Efficiency	Efficiency & PV	Efficiency & PV/Battery
01	5.0	10.5	6.5	31.0	41.0
02	3.0	10.0	4.5	19.0	30.0
03	2.5	10.0	4.0	18.0	29.0
04	2.5	10.0	3.0	17.0	28.5
05	2.5	9.0	4.0	18.0	28.5
06	1.5	9.5	2.0	14.0	26.0
07	n/a	9.0	n/a	11.0	24.0
08	1.0	8.0	1.5	10.5	21.5
09	2.5	8.5	2.5	11.5	21.0
10	3.0	9.5	3.0	11.0	21.0
11	4.0	9.0	4.5	14.0	23.0
12	3.0	9.5	3.5	15.5	25.0
13	4.5	9.5	5.0	13.0	22.0
14	4.5	9.0	5.5	15.5	23.5
15	4.5	7.0	5.5	6.0	13.0
16	5.0	10.5	4.5	26.5	35.0

**Table 19: Summary of Multifamily Target EDR Margins**

Climate Zone	Mixed Fuel		All-Electric		
	Efficiency	Efficiency & PV/Battery	Efficiency	Efficiency & PV	Efficiency & PV/Battery
01	2.0	11.5	3.0	22.5	34.5
02	1.5	10.5	1.5	17.5	30.5
03	0.5	10.0	n/a	16.0	29.5
04	1.0	11.0	1.0	15.0	28.5
05	0.5	9.5	0.5	17.0	30.0
06	1.0	10.5	1.0	13.5	27.5
07	0.5	11.0	0.5	12.5	27.0
08	1.0	9.5	1.0	11.5	24.0
09	1.5	9.5	1.5	11.0	23.0
10	1.5	10.0	1.5	10.5	23.0
11	2.5	10.5	3.5	13.0	25.0
12	1.5	10.0	2.5	14.0	26.5
13	3.0	10.5	3.0	12.0	23.5
14	3.0	9.5	3.5	14.0	24.5
15	4.0	8.5	4.0	7.0	16.5
16	2.0	9.5	3.0	19.5	29.5



## 5 References

- California Energy Commission. 2017. Rooftop Solar PV System. Measure number: 2019-Res-PV-D Prepared by Energy and Environmental Economics, Inc. <https://efiling.energy.ca.gov/getdocument.aspx?tn=221366>
- California Energy Commission. 2018a. 2019 Alternative Calculation Method Approval Manual. CEC-400-2018-023-CMF. December 2018. California Energy Commission. [https://www.energy.ca.gov/2018publications/CEC-400-2018-023-CMF.pdf](https://www.energy.ca.gov/2018publications/CEC-400-2018-023/CEC-400-2018-023-CMF.pdf)
- California Energy Commission. 2018b. 2019 Building Energy Efficiency Standards for Residential and Nonresidential Buildings. CEC-400-2018-020-CMF. December 2018. California Energy Commission. <https://www.energy.ca.gov/2018publications/CEC-400-2018-020/CEC-400-2018-020-CMF.pdf>
- California Energy Commission. 2018c. 2019 Reference Appendices. CEC-400-2018-021-CMF. December 2018. California Energy Commission. <https://www.energy.ca.gov/2018publications/CEC-400-2018-021/CEC-400-2018-021-CMF.pdf>
- California Energy Commission. 2018d. 2019 Residential Compliance Manual. CEC-400-2018-017-CMF. December 2018. California Energy Commission. <https://www.energy.ca.gov/2018publications/CEC-400-2018-017/CEC-400-2018-017-CMF.pdf>
- California Energy Commission. 2019. 2019 Residential Alternative Calculation Method Reference Manual. CEC-400-2019-005-CMF. May 2019. California Energy Commission. <https://www.energy.ca.gov/2019publications/CEC-400-2019-005/CEC-400-2019-005-CMF.pdf>
- California Public Utilities Commission. 2016. Rulemaking No. 15-03-010 An Order Instituting Rulemaking to Identify Disadvantaged Communities in the San Joaquin Valley and Analyze Economically Feasible Options to Increase Access to Affordable Energy in Those Disadvantages Communities. Proposed Decision of Commissioner Guzman Aceves. April 07, 2017. <http://docs.cpuc.ca.gov/PublishedDocs/Efile/G000/M183/K389/183389022.PDF>
- Davis Energy Group. 2015. Evaluation of Ducts in Conditioned Space for New California Homes. Prepared for Pacific Gas and Electric Company. March 2015. <https://www.etcc-ca.com/reports/evaluation-ducts-conditioned-space-new-california-homes>
- Energy & Environmental Economics. 2019. Residential Building Electrification in California. April 2019. [https://www.ethree.com/wp-content/uploads/2019/04/E3\\_Residential\\_Building\\_Electrification\\_in\\_California\\_April\\_2019.pdf](https://www.ethree.com/wp-content/uploads/2019/04/E3_Residential_Building_Electrification_in_California_April_2019.pdf)
- EPRI. 2016. SMUD All-Electric Homes Electrification Case Study: Summary for the Three-Prong Test Discussion. Electric Power Research Institute, Inc. September. 2016. Presentation to Sacramento Municipal Utility District.
- Horii, B., E. Cutter, N. Kapur, J. Arent, and D. Conotyannis. 2014. "Time Dependent Valuation of Energy for Developing Building Energy Efficiency Standards." [http://www.energy.ca.gov/title24/2016standards/prerulemaking/documents/2014-07-09\\_workshop/2017\\_TDV\\_Documents/](http://www.energy.ca.gov/title24/2016standards/prerulemaking/documents/2014-07-09_workshop/2017_TDV_Documents/)
- Itron. 2014. 2010-2012 WO017 Ex Ante Measure Cost Study: Final Report. Itron. May 2014. Presented to California Public Utilities Commission.
- Barbose, Galen and Darghouth, Naim. 2018. Tracking the Sun. Installed Price Trends for Distributed Photovoltaic Systems in the United States – 2018 Edition. Lawrence Berkeley National Laboratory. September 2018. [https://emp.lbl.gov/sites/default/files/tracking\\_the\\_sun\\_2018\\_edition\\_final\\_0.pdf](https://emp.lbl.gov/sites/default/files/tracking_the_sun_2018_edition_final_0.pdf)
- Navigant. 2018. Analysis of the Role of Gas for a Low-Carbon California Future. July 24, 2018. Prepared for Southern California Gas Company. [https://www.socalgas.com/1443741887279/SoCalGas\\_Renewable\\_Gas\\_Final-Report.pdf](https://www.socalgas.com/1443741887279/SoCalGas_Renewable_Gas_Final-Report.pdf)



- Penn, Ivan. 2018. Cheaper Battery Is Unveiled as a Step to a Carbon-Free Grid. The New York Times. September 2018. <https://www.nytimes.com/2018/09/26/business/energy-environment/zinc-battery-solar-power.html>. Accessed January 29, 2019.
- Statewide CASE Team. 2017a. Codes and Standards Enhancement (CASE) Initiative Drain Water Heat Recovery – Final Report. July 2017. [http://title24stakeholders.com/wp-content/uploads/2017/09/2019-T24-CASE-Report\\_DWHR\\_Final\\_September-2017.pdf](http://title24stakeholders.com/wp-content/uploads/2017/09/2019-T24-CASE-Report_DWHR_Final_September-2017.pdf)
- Statewide CASE Team. 2017b. Codes and Standards Enhancement (CASE) Initiative High Performance Attics – Final Report. September 2017. [http://title24stakeholders.com/wp-content/uploads/2017/09/2019-T24-CASE-Report\\_HPA\\_Final\\_September-2017.pdf](http://title24stakeholders.com/wp-content/uploads/2017/09/2019-T24-CASE-Report_HPA_Final_September-2017.pdf)
- Statewide CASE Team. 2017c. Codes and Standards Enhancement (CASE) Initiative High Performance Walls – Final Report. September 2017. [http://title24stakeholders.com/wp-content/uploads/2017/09/2019-T24-CASE-Report\\_HPW\\_Final\\_September-2017.pdf](http://title24stakeholders.com/wp-content/uploads/2017/09/2019-T24-CASE-Report_HPW_Final_September-2017.pdf)
- Statewide CASE Team. 2017d. Codes and Standards Enhancement (CASE) Initiative Residential High Performance Windows & Doors – Final Report. August 2017. [http://title24stakeholders.com/wp-content/uploads/2017/09/2019-T24-CASE-Report\\_Res-Windows-and-Doors\\_Final\\_September-2017.pdf](http://title24stakeholders.com/wp-content/uploads/2017/09/2019-T24-CASE-Report_Res-Windows-and-Doors_Final_September-2017.pdf)
- Statewide CASE Team. 2018. Energy Savings Potential and Cost-Effectiveness Analysis of High Efficiency Windows in California. Prepared by Frontier Energy. May 2018. <https://www.etcc-ca.com/reports/energy-savings-potential-and-cost-effectiveness-analysis-high-efficiency-windows-california>
- Statewide Reach Codes Team. 2016. CALGreen Cost-Effectiveness Study. Prepared for Pacific Gas and Electric Company. Prepared by Davis Energy Group. November 2016. [http://localenergycodes.com/download/50/file\\_path/fieldList/2016%20RNC%20Tiers%201-2%20Cost-Eff%20Report](http://localenergycodes.com/download/50/file_path/fieldList/2016%20RNC%20Tiers%201-2%20Cost-Eff%20Report)
- Statewide Reach Codes Team. 2017a. CALGreen All-Electric Cost-Effectiveness Study. Prepared for Pacific Gas and Electric Company. Prepared by Davis Energy Group. October 2017. [http://localenergycodes.com/download/276/file\\_path/fieldList/2016%20RNC%20All-Electric%20Cost-Eff%20Report](http://localenergycodes.com/download/276/file_path/fieldList/2016%20RNC%20All-Electric%20Cost-Eff%20Report)
- Statewide Reach Codes Team. 2017b. 2016 Title 24 Residential Reach Code Recommendations: Cost-effectiveness Analysis for All California Climate Zones. Prepared for Southern California Edison. Prepared by TRC Energy Services. August 2017. [http://localenergycodes.com/download/283/file\\_path/fieldList/2016%20RNC%20Reach%20Code%20Tier%203%20Cost-Eff%20Report](http://localenergycodes.com/download/283/file_path/fieldList/2016%20RNC%20Reach%20Code%20Tier%203%20Cost-Eff%20Report)
- Statewide Reach Codes Team. 2018. PV + Battery Storage Study. Prepared for Pacific Gas and Electric Company. Prepared by EnergySoft. July, 2018. [http://localenergycodes.com/download/430/file\\_path/fieldList/PV%20Plus%20Battery%20Storage%20Report](http://localenergycodes.com/download/430/file_path/fieldList/PV%20Plus%20Battery%20Storage%20Report)
- Hopkins, Asa, Takahashi, Kenji, Glick, Devi, Whited, Melissa. 2018. Decarbonization of Heating Energy Use in California Buildings. Synapse Energy Economics, Inc. October 2018. <http://www.synapse-energy.com/sites/default/files/Decarbonization-Heating-CA-Buildings-17-092-1.pdf>
- TRC. 2018. City of Palo Alto 2019 Title 24 Energy Reach Code Cost-effectiveness Analysis Draft. September 2018. <https://cityofpaloalto.org/civicax/filebank/documents/66742>



# Appendix A - California Climate Zone Map

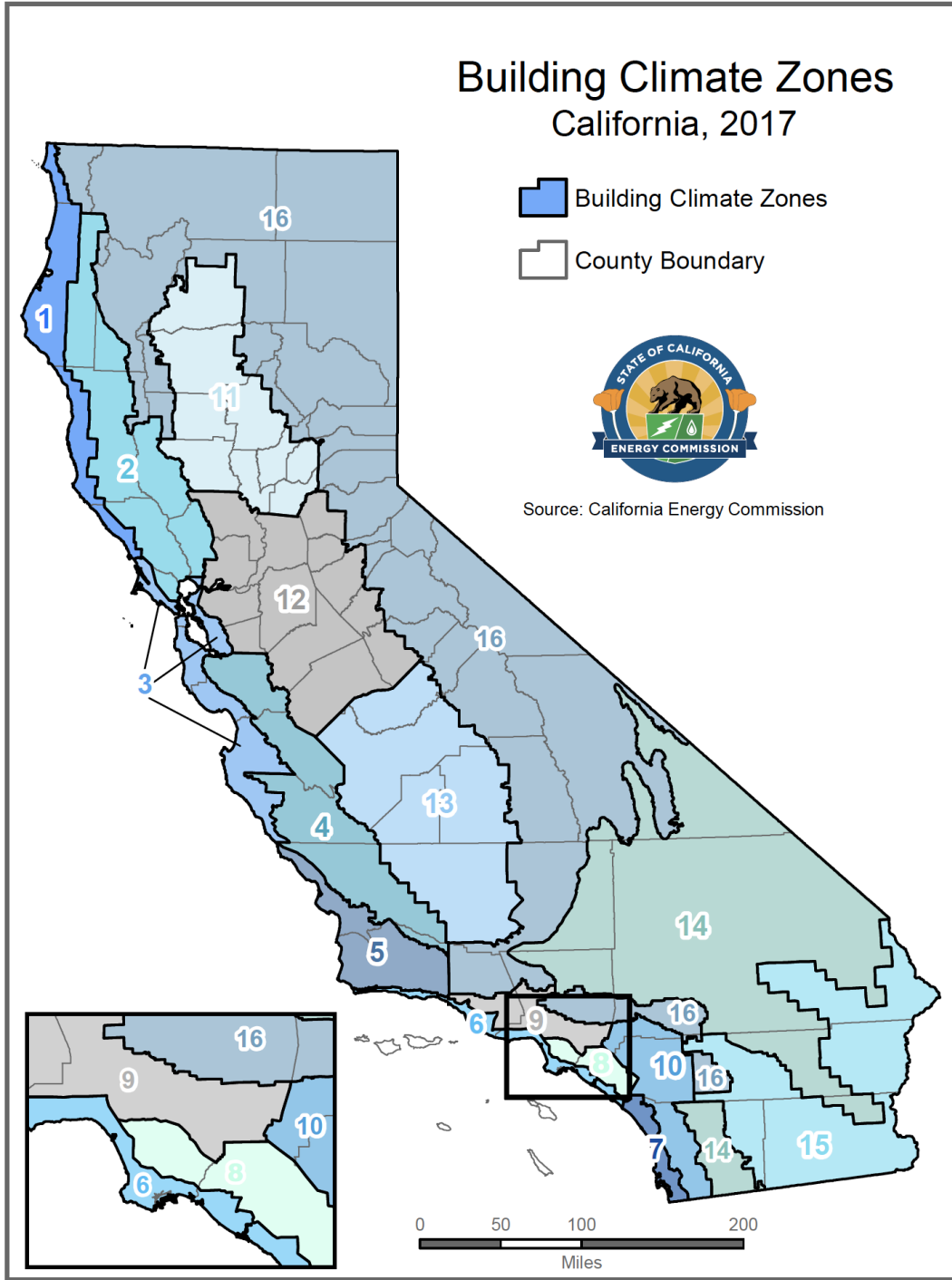


Figure 15: Map of California Climate Zones (courtesy of the California Energy Commission<sup>17</sup>)

<sup>17</sup> [https://ww2.energy.ca.gov/maps/renewable/building\\_climate\\_zones.html](https://ww2.energy.ca.gov/maps/renewable/building_climate_zones.html)



## Appendix B – Utility Tariff Details

PG&E .....	48
SCE .....	51
SoCalGas .....	53
SDG&E.....	54
Escalation Assumptions .....	56





**PG&E**

The following pages provide details on the PG&E electricity and natural gas tariffs applied in this study. Table 20 describes the baseline territories that were assumed for each climate zone.

**Table 20: PG&E Baseline Territory by Climate Zone**

	Baseline Territory
CZ01	V
CZ02	X
CZ03	T
CZ04	X
CZ05	T
CZ11	R
CZ12	S
CZ13	R
CZ16	Y

The PG&E monthly gas rate in \$/therm was applied on a monthly basis for the 12-month period ending January 2019 according to the rates shown below.

Pacific Gas and Electric Company Residential Non-CARE and CARE Gas Tariff Rates January 1, 2018, to Present (\$/therm) <sup>1/</sup>							
Effective Date	Advice Letter Number	Minimum Transportation Charge <sup>2/</sup> (per day)	Procurement Charge	Transportation Charge <sup>2/</sup>		TOTAL Residential Non-CARE Schedules Charge <sup>3/</sup>	
				Baseline	Excess	Baseline	Excess
01/01/18	3918-G	\$0.09863	\$0.37310	\$0.91828	\$1.46925	\$1.29138	\$1.84235
02/01/18	3931-G	\$0.09863	\$0.40635	\$0.91828	\$1.46925	\$1.32463	\$1.87560
03/01/18	3941-G	\$0.09863	\$0.32103	\$0.91828	\$1.46925	\$1.23931	\$1.79028
04/01/18	3959-G	\$0.09863	\$0.34783	\$0.91828	\$1.46925	\$1.26611	\$1.81708
05/01/18	3969-G	\$0.09863	\$0.26995	\$0.91828	\$1.46925	\$1.18823	\$1.73920
06/01/18	3980-G	\$0.09863	\$0.21571	\$0.91828	\$1.46925	\$1.13399	\$1.68496
07/01/18	3984-G	\$0.09863	\$0.22488	\$0.93438	\$1.49502	\$1.15926	\$1.71990
08/01/18	3995-G	\$0.09863	\$0.28814	\$0.93438	\$1.49502	\$1.22252	\$1.78316
09/01/18	4008-G	\$0.09863	\$0.25597	\$0.93438	\$1.49502	\$1.19035	\$1.75099
10/01/18	4018-G	\$0.09863	\$0.27383	\$0.93438	\$1.49502	\$1.20821	\$1.76885
11/01/18	4034-G	\$0.09863	\$0.35368	\$0.93438	\$1.49502	\$1.28806	\$1.84870
12/01/18	4046-G	\$0.09863	\$0.42932	\$0.93438	\$1.49502	\$1.36370	\$1.92434
01/01/19	4052-G	\$0.09863	\$0.43394 <sup>7/</sup>	\$0.99414	\$1.59063	\$1.42808	\$2.02457

<sup>1/</sup> Unless otherwise noted  
<sup>2/</sup> Effective July 1, 2005, the Transportation Charge will be no less than the Minimum Transportation Charge of \$0.09863 (per day). Applicable to Rate Schedule G-1 only and does not apply to submetered tenants of master-metered customers served under gas Rate Schedule GS and GT.  
<sup>3/</sup> Schedule G-PPPS (Public Purpose Program Surcharge) needs to be added to the TOTAL Non-CARE Charge and TOTAL CARE Charge for bill calculation. See Schedule G-PPPS for details and exempt customers.  
<sup>4/</sup> CARE Schedules include California Solar Initiative (CSI) Exemption in accordance with Advice Letter 3257-G-A.  
<sup>5/</sup> Per dwelling unit per day (Multifamily Service)  
<sup>6/</sup> Per installed space per day (Mobilehome Park Service)  
<sup>7/</sup> This procurement rate includes a charge of \$0.03686 per therm to reflect account balance amortizations in accordance with Advice Letter 3157-G.  
<sup>8/</sup> Residential bill credit of (\$29.85) per household, annual bill credit occurring in the October 2018 bill cycle, thereafter in the April bill cycle.  
Seasons: Winter = Nov-Mar Summer = April-Oct





Cancelling Revised Cal. P.U.C. Sheet No. 43533-E  
 Revised Cal. P.U.C. Sheet No. 42728-E

ELECTRIC SCHEDULE E-TOU  
 RESIDENTIAL TIME-OF-USE SERVICE

Sheet 4

RATES:  
 (Cont'd.)

OPTION B TOTAL RATES

Total Energy Rates (\$ per kWh)	PEAK	OFF-PEAK
Summer (all usage)	\$0.37188 (R)	\$0.26882 (R)
Winter (all usage)	\$0.23441 (R)	\$0.21561 (R)

Delivery Minimum Bill Amount (\$ per meter per day)      \$0.32854

California Climate Credit (per household, per semi-annual payment occurring in the April and October bill cycles)      (\$39.42)

Total bundled service charges shown on customer's bills are unbundled according to the component rates shown below. Where the delivery minimum bill amount applies, the customer's bill will equal the sum of (1) the delivery minimum bill amount plus (2) for bundled service, the generation rate times the number of kWh used. For revenue accounting purposes, the revenues from the delivery minimum bill amount will be assigned to the Transmission, Transmission Rate Adjustments, Reliability Services, Public Purpose Programs, Nuclear Decommissioning, Competition Transition Charges, Energy Cost Recovery Amount, DWR Bond, and New System Generation Charges based on kWh usage times the corresponding unbundled rate component per kWh, with any residual revenue assigned to Distribution.\*\*\*

UNBUNDLING OF OPTION B TOTAL RATES

Generation	PEAK	OFF-PEAK
Summer (all usage)	\$0.21238	\$0.10932
Winter (all usage)	\$0.10554	\$0.08674
Distribution**		
Summer (all usage)	\$0.10716 (R)	\$0.10716 (R)
Winter (all usage)	\$0.07653 (R)	\$0.07653 (R)
Transmission* (all usage)	\$0.02469 (R)	
Transmission Rate Adjustments* (all usage)	\$0.00214	
Reliability Services* (all usage)	\$0.00260	
Public Purpose Programs (all usage)	\$0.01413	
Nuclear Decommissioning (all usage)	\$0.00020	
Competition Transition Charges (all usage)	\$0.00132	
Energy Cost Recovery Amount (all usage)	(\$0.00005)	
DWR Bond (all usage)	\$0.00503 (R)	
New System Generation Charge (all usage)**	\$0.00228	

\* Transmission, Transmission Rate Adjustments and Reliability Service charges are combined for presentation on customer bills.  
 \*\* Distribution and New System Generation Charges are combined for presentation on customer bills.  
 \*\*\* This same assignment of revenues applies to direct access and community choice aggregation customers.

(Continued)

Advice	5444-E	Issued by	Submitted	December 18, 2018
Decision	18-08-013	Robert S. Kenney	Effective	January 1, 2019
		Vice President, Regulatory Affairs	Resolution	





Revised Cal. P.U.C. Sheet No. 34735-G  
Cancelling Revised Cal. P.U.C. Sheet No. 34691-G

**GAS SCHEDULE G-1  
RESIDENTIAL SERVICE**

Sheet 1

**APPLICABILITY:** This rate schedule<sup>1</sup> applies to natural gas service to Core End-Use Customers on PG&E's Transmission and/or Distribution Systems. To qualify, service must be to individually-metered single family premises for residential use, including those in a multifamily complex, and to separately-metered common areas in a multifamily complex where Schedules GM, GS, or GT are not applicable. Common area accounts that are separately metered by PG&E have an option of switching to a core commercial rate schedule. Common area accounts are those accounts that provide gas service to common use areas as defined in Rule 1.

Per D.15-10-032 and D.18-03-017, transportation rates include GHG Compliance Cost for non-covered entities. Customers who are directly billed by the Air Resources Board (ARB), i.e., covered entities, are exempt from paying AB 32 GHG Compliance Costs through PG&E's rates.<sup>2</sup> A "Cap-and-Trade Cost Exemption" credit for these costs will be shown as a line item on exempt customers' bills.<sup>3,4</sup>

**TERRITORY:** Schedule G-1 applies everywhere within PG&E's natural gas Service Territory.

**RATES:** Customers on this schedule pay a Procurement Charge and a Transportation Charge, per meter, as shown below. The Transportation Charge will be no less than the Minimum Transportation Charge, as follows:

<u>Minimum Transportation Charge:</u> <sup>5</sup>		<u>Per Day</u>		
		\$0.09863		
		<u>Per Therm</u>		
	<u>Baseline</u>		<u>Excess</u>	
<b>Procurement:</b>	\$0.43394	(l)	\$0.43394	(l)
<b>Transportation Charge:</b>	\$0.99414	(l)	\$1.59063	(l)
<b>Total:</b>	\$1.42808	(l)	\$2.02457	(l)
California Natural Gas Climate Credit (per Household, annual payment occurring in October 2018 bill cycle, and thereafter in the April bill cycle)	(\$25.45)	(l)		

Public Purpose Program Surcharge:

Customers served under this schedule are subject to a gas Public Purpose Program (PPP) Surcharge under Schedule G-PPPS.

See Preliminary Statement, Part B for the Default Tariff Rate Components.

The Procurement Charge on this schedule is equivalent to the rate shown on informational Schedule G-CP—Gas Procurement Service to Core End-Use Customers.

<sup>1</sup> PG&E's gas tariffs are available online at [www.pge.com](http://www.pge.com).

<sup>2</sup> Covered entities are not exempt from paying costs associated with LUAF Gas and Gas used by Company Facilities.

<sup>3</sup> The exemption credit will be equal to the effective non-exempt AB 32 GHG Compliance Cost Rate (\$ per therm) included in Preliminary Statement – Part B, multiplied by the customer's billed volumes (therms) for each billing period.

<sup>4</sup> PG&E will update its billing system annually to reflect newly exempt or newly excluded customers to conform with lists of Directly Billed Customers provided annually by the ARB.

<sup>5</sup> The Minimum Transportation charge does not apply to submetered tenants of master-metered customers served under gas rate Schedules GS and GT.

(Continued)

<i>Advice</i>	4052-G	<i>Issued by</i>	<i>Submitted</i>	December 21, 2018
<i>Decision</i>	97-10-065 & 98-07-025	<b>Robert S. Kenney</b> <i>Vice President, Regulatory Affairs</i>	<i>Effective</i>	January 1, 2019
			<i>Resolution</i>	



**SCE**

The following pages provide details on are the SCE electricity tariffs applied in this study. Table 21 describes the baseline territories that were assumed for each climate zone.

**Table 21: SCE Baseline Territory by Climate Zone**

	<b>Baseline Territory</b>
CZ06	6
CZ08	8
CZ09	9
CZ10	10
CZ14	14
CZ15	15

	Delivery	Generation	Total Rate
<b>TOU-Default-Rate-1 (On-Peak 4:00 pm - 9:00 pm)</b>			
Energy Charge - \$/kWh			
Summer Season - On-Peak	0.19880	0.20072	0.39952
Mid-Peak	0.19880	0.05948	0.25828
Off-Peak	0.15574	0.06023	0.21597
Winter Season - Mid-Peak	0.19880	0.08308	0.28188
Off-Peak	0.15574	0.11309	0.26883
Super-Off-Peak	0.15062	0.01344	0.16406
Basic Charge - \$/day			
Single-Family Residence	0.031	0.000	0.031
Multi-Family Residence	0.024	0.000	0.024
Minimum Charge - \$/day			
Single Family Residence	0.338	0.000	0.338
Multi-Family Residence	0.338	0.000	0.338
Baseline Credit - \$/kWh	(0.06512)	0.00000	(0.06512)



	Delivery	Generation	Total Rate
<b>TOU-D-Rate PRIME</b>			
Energy Charge - \$/kWh			
Summer Season - On-Peak	0.15926	0.19811	0.35737
Mid-Peak	0.15926	0.10092	0.26018
Off-Peak	0.08308	0.04687	0.12995
Winter Season - Mid-Peak	0.16268	0.16761	0.33029
Off-Peak	0.08081	0.04331	0.12412
Super-Off-Peak	0.08081	0.04331	0.12412
Customer Charge - \$/day	0.395	0.000	0.395

TOU Period	Weekdays		Weekends and Holidays	
	Summer	Winter	Summer	Winter
On-Peak	4 p.m. - 9 p.m.			
Mid-Peak		4 p.m. - 9 p.m.	4 p.m. - 9 p.m.	4 p.m. - 9 p.m.
Off-Peak	All other hours	9 p.m. - 8 a.m.	All other hours	9 p.m. - 8 a.m.
Super-Off-Peak		8 a.m. - 4 p.m.		8 a.m. - 4 p.m.

**PROPOSED**  
(7 Year Average 2010-2016)

Summer kWh per Day			Winter kWh per Day		
Baseline Region	Basic	All Electric	Baseline Region	Basic	All Electric
05	17.2	17.9	05	18.7	29.1
06	11.4	8.8	06	11.3	13.0
08	12.6	9.8	08	10.6	12.7
09	16.5	12.4	09	12.3	14.3
10	18.9	15.8	10	12.5	17.0
13	22.0	24.6	13	12.6	24.3
14	18.7	18.3	14	12.0	21.3
15	46.4	24.1	15	9.9	18.2
16	14.4	13.5	16	12.6	23.1



**SoCalGas**

Following are the SoCalGas natural gas tariffs applied in this study. Table 22 describes the baseline territories that were assumed for each climate zone.

**Table 22: SoCalGas Baseline Territory by Climate Zone**

	<b>Baseline Territory</b>
CZ05	2
CZ06	1
CZ08	1
CZ09	1
CZ10	1
CZ14	2
CZ15	1

SOUTHERN CALIFORNIA GAS COMPANY Revised CAL P.U.C. SHEET NO. 55854-G  
 LOS ANGELES, CALIFORNIA CANCELING Revised CAL P.U.C. SHEET NO. 55828-G

Schedule No. GR			Sheet 1
<b>RESIDENTIAL SERVICE</b>			
(Includes GR, GR-C and GT-R Rates)			
<b>APPLICABILITY</b>			
The GR rate is applicable to natural gas procurement service to individually metered residential customers.			
The GR-C, cross-over rate, is a core procurement option for individually metered residential core transportation customers with annual consumption over 50,000 therms, as set forth in Special Condition 10.			
The GT-R rate is applicable to Core Aggregation Transportation (CAT) service to individually metered residential customers, as set forth in Special Condition 11.			
The California Alternate Rates for Energy (CARE) discount of 20%, reflected as a separate line item on the bill, is applicable to income-qualified households that meet the requirements for the CARE program as set forth in Schedule No. G-CARE.			
<b>TERRITORY</b>			
Applicable throughout the service territory.			
<b>RATES</b>			
	<u>GR</u>	<u>GR-C</u>	<u>GT-R</u>
Customer Charge, per meter per day:	16.438¢	16.438¢	16.438¢
For "Space Heating Only" customers, a daily Customer Charge applies during the winter period from November 1 through April 30 <sup>1/</sup> :			
	33.149¢	33.149¢	33.149¢
<b>Baseline Rate, per therm (baseline usage defined in Special Conditions 3 and 4):</b>			
Procurement Charge: <sup>2/</sup>	41.589¢	42.676¢	N/A
Transmission Charge:	63.566¢	63.566¢	63.566¢
Total Baseline Charge:	105.155¢	106.242¢	63.566¢
<b>Non-Baseline Rate, per therm (usage in excess of baseline usage):</b>			
Procurement Charge: <sup>2/</sup>	41.589¢	42.676¢	N/A
Transmission Charge:	96.806¢	96.806¢	96.806¢
Total Non-Baseline Charge:	138.395¢	139.482¢	96.806¢
<sup>1/</sup> For the summer period beginning May 1 through October 31, with some exceptions, usage will be accumulated to at least 20 Ccf (100 cubic feet) before billing.			
(Footnotes continue next page.)			

R  
R  
R  
R

(Continued)

(TO BE INSERTED BY UTILITY)  
 ADVICE LETTER NO. 5410  
 DECISION NO.  
 106

ISSUED BY  
**Dan Skopec**  
 Vice President  
 Regulatory Affairs

(TO BE INSERTED BY CAL. PUC)  
 SUBMITTED Jan 7, 2019  
 EFFECTIVE Jan 10, 2019  
 RESOLUTION NO. G-3351



**SDG&E**

Following are the SDG&E electricity and natural gas tariffs applied in this study. Table 23 describes the baseline territories that were assumed for each climate zone.

**Table 23: SDG&E Baseline Territory by Climate Zone**

	Baseline Territory
CZ07	Coastal
CZ10	Inland
CZ14	Mountain



San Diego Gas & Electric Company  
San Diego, California

Revised Cal. P.U.C. Sheet No. 31320-E  
Canceling Revised Cal. P.U.C. Sheet No. 31103-E

SCHEDULE TOU-DR1					Sheet 2	
RESIDENTIAL TIME-OF-USE						
<u>RATES</u>						
<u>Total Rates:</u>						
Description – TOU DR1	UDC Total Rate	DWR-BC Rate	EECC Rate + DWR Credit	Total Rate		
<b>Summer:</b>						
On-Peak	0.29562	R 0.00503	R 0.35013	R 0.65078	R	
Off-Peak	0.29562	R 0.00503	R 0.11235	R 0.41300	R	
Super Off-Peak	0.29562	R 0.00503	R 0.05739	R 0.35804	R	
<b>Winter:</b>						
On-Peak	0.32037	R 0.00503	R 0.07618	R 0.40158	R	
Off-Peak	0.32037	R 0.00503	R 0.06762	R 0.39302	R	
Super Off-Peak	0.32037	R 0.00503	R 0.05812	R 0.38352	R	
Summer Baseline Adjustment Credit up to 130% of Baseline	(0.19921)	I		(0.19921)	I	
Winter Baseline Adjustment Credit up to 130% of Baseline	(0.16853)	I		(0.16853)	I	
Minimum Bill (\$/day)	0.329			0.329		
Description – TOU DR1	UDC Total Rate	DWR-BC Rate	EECC Rate + DWR Credit	Total Rate	Total Effective Care Rate	
<b>Summer – CARE</b>						
<b>Rates:</b>						
On-Peak	0.29494	R 0.00000	0.35013 R	0.64507 R	0.41628 R	
Off-Peak	0.29494	R 0.00000	0.11235 R	0.40729 R	0.26077 R	
Super Off-Peak	0.29494	R 0.00000	0.05739 R	0.35233 R	0.22483 R	
<b>Winter – CARE</b>						
<b>Rates:</b>						
On-Peak	0.31989	R 0.00000	0.07618 R	0.39587 R	0.25330 R	
Off-Peak	0.31989	R 0.00000	0.06762 R	0.38731 R	0.24770 R	
Super Off-Peak	0.31989	R 0.00000	0.05812 R	0.37781 R	0.24149 R	
Summer Baseline Adjustment Credit up to 130% of Baseline	(0.19921)	I		(0.19921) I	(0.13028) I	
Winter Baseline Adjustment Credit up to 130% of Baseline	(0.16853)	I		(0.16853) I	(0.11022) I	
Minimum Bill (\$/day)	0.164			0.164	0.164	
Note:						
(1) Total Rates consist of UDC, Schedule DWR-BC (Department of Water Resources Bond Charge), and Schedule EECC (Electric Energy Commodity Cost) rates, with the EECC rates reflecting a DWR Credit.						
(2) Total Rates presented are for customers that receive commodity supply and delivery service from Utility.						
(3) DWR-BC charges do not apply to CARE customers.						
(4) As identified in the rates tables, customer bills will also include line-item summer and winter credits for usage up to 130% of baseline to provide the rate capping benefits adopted by Assembly Bill 1X and Senate Bill 695.						

(Continued)

2C11

Advice Ltr. No. 3326-E

Decision No. \_\_\_\_\_

Issued by  
**Dan Skopec**  
Vice President  
Regulatory Affairs

Submitted Dec 28, 2018

Effective Jan 1, 2019

Resolution No. \_\_\_\_\_





San Diego Gas & Electric Company  
San Diego, California

Revised Cal. P.U.C. Sheet No. 23614-G

Canceling Revised Cal. P.U.C. Sheet No. 23601-G

**SCHEDULE GR**

Sheet 1

RESIDENTIAL NATURAL GAS SERVICE  
(Includes Rates for GR, GR-C, GTC/GTCA)

APPLICABILITY

The GR rate is applicable to natural gas procurement service for individually metered residential customers.

The GR-C, cross-over rate, is a core procurement option for individually metered residential core transportation customers with annual consumption over 50,000 therms, as set forth in Special Condition 10.

The GTC/GTCA rate is applicable to intrastate gas transportation-only services to individually metered residential customers, as set forth in Special Condition 11.

Customers taking service under this schedule may be eligible for a 20% California Alternate Rate for Energy (CARE) program discount, reflected as a separate line item on the bill, if they qualify to receive service under the terms and conditions of Schedule G-CARE.

TERRITORY

Within the entire territory served natural gas by the utility.

RATES

	<u>GR</u>	<u>GR-C</u>	<u>GTC/GTCA<sup>1/</sup></u>
<u>Baseline Rate</u> , per therm (baseline usage defined in Special Conditions 3 and 4):			
Procurement Charge: <sup>2/</sup> .....	\$0.41614	\$0.41614 R	N/A
Transmission Charge: .....	<u>\$1.01230</u>	<u>\$1.01230</u>	<u>\$1.01230</u>
Total Baseline Charge: .....	\$1.42844	\$1.42844 R	\$1.01230
 <u>Non-Baseline Rate</u> , per therm (usage in excess of baseline usage):			
Procurement Charge: <sup>2/</sup> .....	\$0.41614	\$0.41614 R	N/A
Transmission Charge: .....	<u>\$1.19980</u>	<u>\$1.19980</u>	<u>\$1.19980</u>
Total Non-Baseline Charge: .....	\$1.61594	\$1.61594 R	\$1.19980
 <u>Minimum Bill</u> , per day: <sup>3/</sup>			
Non-CARE customers: .....	\$0.09863	\$0.09863	\$0.09863
CARE customers: .....	\$0.07890	\$0.07890	\$0.07890

<sup>1/</sup> The rates for core transportation-only customers, with the exception of customers taking service under Schedule GT-NGV, include any FERC Settlement Proceeds Memorandum Account (FSPMA) credit adjustments.

<sup>2/</sup> This charge is applicable to Utility Procurement Customers and includes the GPC and GPC-A Procurement Charges shown in Schedule GPC which are subject to change monthly as set forth in Special Condition 7.

<sup>3/</sup> Effective starting May 1, 2017, the minimum bill is calculated as the minimum bill charge of \$0.09863 per day times the number of days in the billing cycle (approximately \$3 per month) with a 20% discount applied for CARE customer resulting in a minimum bill charge of \$0.07890 per day (approximately \$2.40 per month).

(Continued)

1C5  
Advice Ltr. No. 2735-G  
Decision No. \_\_\_\_\_

Issued by  
**Dan Skopec**  
Vice President  
Regulatory Affairs

Submitted Jan 7, 2019  
Effective Jan 10, 2019  
Resolution No. \_\_\_\_\_





**Escalation Assumptions**

The average annual escalation rates in the following table were used in this study and are from E3’s 2019 study Residential Building Electrification in California (Energy & Environmental Economics, 2019). These rates are applied to the 2019 rate schedules over a thirty-year period beginning in 2020. SDG&E was not covered in the E3 study. The Reach Code Team reviewed SDG&E’s GRC filing and applied the same approach that E3 applied for PG&E and SoCalGas to arrive at average escalation rates between 2020 and 2022.

**Table 24: Real Utility Rate Escalation Rate Assumptions**

	Statewide Electric Residential Average Rate (%/year, real)	Natural Gas Residential Core Rate (%/yr escalation, real)		
		PG&E	SoCalGas	SDG&E
2020	2.0%	1.48%	6.37%	5.00%
2021	2.0%	5.69%	4.12%	3.14%
2022	2.0%	1.11%	4.12%	2.94%
2023	2.0%	4.0%	4.0%	4.0%
2024	2.0%	4.0%	4.0%	4.0%
2025	2.0%	4.0%	4.0%	4.0%
2026	1.0%	1.0%	1.0%	1.0%
2027	1.0%	1.0%	1.0%	1.0%
2028	1.0%	1.0%	1.0%	1.0%
2029	1.0%	1.0%	1.0%	1.0%
2030	1.0%	1.0%	1.0%	1.0%
2031	1.0%	1.0%	1.0%	1.0%
2032	1.0%	1.0%	1.0%	1.0%
2033	1.0%	1.0%	1.0%	1.0%
2034	1.0%	1.0%	1.0%	1.0%
2035	1.0%	1.0%	1.0%	1.0%
2036	1.0%	1.0%	1.0%	1.0%
2037	1.0%	1.0%	1.0%	1.0%
2038	1.0%	1.0%	1.0%	1.0%
2039	1.0%	1.0%	1.0%	1.0%
2040	1.0%	1.0%	1.0%	1.0%
2041	1.0%	1.0%	1.0%	1.0%
2042	1.0%	1.0%	1.0%	1.0%
2043	1.0%	1.0%	1.0%	1.0%
2044	1.0%	1.0%	1.0%	1.0%
2045	1.0%	1.0%	1.0%	1.0%
2046	1.0%	1.0%	1.0%	1.0%
2047	1.0%	1.0%	1.0%	1.0%
2048	1.0%	1.0%	1.0%	1.0%
2049	1.0%	1.0%	1.0%	1.0%



## Appendix C – Single Family Detailed Results

Table 25: Single Family Mixed Fuel Efficiency Package Cost-Effectiveness Results

CZ	Utility	BASECASE					Non-Preempted							Equipment - Preempted								
		Total EDR	Efficiency EDR	CALGreen Tier 1 EDR Target	lbs CO2 per sqft	PV kW	Total EDR	Efficiency EDR	Efficiency EDR Margin	% Comp Margin	lbs CO2 per sqft	PV kW	On-Bill B/C Ratio	TDV B/C Ratio	Total EDR	Efficiency EDR	Efficiency EDR Margin	% Comp Margin	lbs CO2 per sqft	PV kW	On-Bill B/C Ratio	TDV B/C Ratio
1	PG&E	32.5	54.2	23	3.0	3.3	27.9	49.0	5.3	18.8%	2.5	3.2	3.4	2.8	26.0	47.3	6.9	25.1%	2.3	3.2	4.9	4.1
2	PG&E	25.0	46.0	12	2.2	2.8	22.0	42.7	3.3	16.3%	1.9	2.8	1.6	1.7	21.8	42.6	3.3	16.4%	1.9	2.8	3.8	3.6
3	PG&E	23.9	46.9	10	1.9	2.7	21.3	43.9	3.0	16.7%	1.6	2.7	1.3	1.3	20.1	42.8	4.1	22.8%	1.5	2.7	1.9	2.0
4	PG&E	23.1	44.9	8	1.9	2.7	20.8	42.4	2.5	13.9%	1.7	2.7	0.9	1.2	20.5	42.2	2.7	14.9%	1.6	2.7	2.4	2.7
5	PG&E	22.2	44.4	10	1.8	2.6	19.7	41.7	2.7	16.7%	1.6	2.5	1.1	1.2	19.7	41.7	2.6	16.2%	1.5	2.5	2.3	2.5
5	PG&E/SoCalGas	22.2	44.4	10	1.8	2.6	19.7	41.7	2.7	16.7%	1.6	2.5	0.9	1.2	19.7	41.7	2.6	16.2%	1.5	2.5	2.0	2.5
6	SCE/SoCalGas	23.3	49.9	10	1.6	2.7	21.5	47.8	2.0	12.1%	1.5	2.7	0.7	1.2	21.5	47.9	2.0	11.8%	1.4	2.7	1.6	2.0
7	SDG&E	20.3	49.1	5	1.3	2.6	20.3	49.1	0.0	0.0%	1.3	2.6	-	-	18.8	47.6	1.5	12.4%	1.2	2.6	1.5	1.4
8	SCE/SoCalGas	21.3	46.9	10	1.4	2.9	20.1	45.6	1.3	7.7%	1.3	2.9	0.6	1.4	19.7	45.3	1.6	9.4%	1.3	2.9	1.3	1.8
9	SCE/SoCalGas	24.5	47.7	13	1.5	2.9	22.3	45.1	2.6	11.7%	1.5	2.9	0.7	2.0	21.9	44.8	2.9	13.4%	1.4	2.9	1.8	3.7
10	SCE/SoCalGas	24.2	46.3	10	1.6	3.0	21.7	43.1	3.2	14.3%	1.5	3.0	0.6	1.3	21.5	43.1	3.2	14.6%	1.4	3.0	2.0	3.8
10	SDG&E	24.2	46.3	10	1.6	3.0	21.7	43.1	3.2	14.3%	1.5	3.0	0.8	1.3	21.5	43.1	3.2	14.6%	1.4	3.0	2.6	3.8
11	PG&E	24.6	44.9	11	2.1	3.6	21.3	40.6	4.3	16.4%	1.9	3.4	0.8	1.2	20.7	39.9	5.1	19.2%	1.8	3.4	2.5	3.7
12	PG&E	25.5	44.8	12	2.1	3.0	22.5	41.3	3.5	14.9%	1.9	2.9	1.2	1.8	22.5	41.4	3.4	14.4%	1.9	3.0	3.3	4.6
13	PG&E	25.7	46.5	11	2.0	3.8	22.2	41.9	4.6	16.9%	1.8	3.6	0.8	1.3	21.2	40.7	5.8	21.4%	1.7	3.6	5.3	8.4
14	SCE/SoCalGas	25.3	46.3	15	2.3	3.2	21.5	41.3	5.0	18.5%	2.1	3.0	1.6	2.5	20.8	40.4	5.8	21.7%	2.0	3.0	4.0	6.1
14	SDG&E	25.3	46.3	15	2.3	3.2	21.5	41.3	5.0	18.5%	2.1	3.0	1.9	2.5	20.8	40.4	5.8	21.7%	2.0	3.0	4.9	6.1
15	SCE/SoCalGas	22.4	49.1	11	1.7	5.4	19.7	44.3	4.8	14.8%	1.6	5.0	1.0	1.6	19.5	44.1	5.0	15.4%	1.5	5.0	>1	>1
16	PG&E	30.4	48.9	22	3.3	2.7	25.0	43.5	5.4	20.6%	2.6	2.7	1.6	1.5	24.8	42.7	6.2	23.5%	2.7	2.6	2.2	2.2

">1" = indicates cases where there is both first cost savings and annual utility bill savings.



Table 26: Single Family Mixed Fuel Efficiency &amp; PV/Battery Package Cost-Effectiveness Results

CZ	Utility	BASECASE				Efficiency & PV/Battery						
		Total EDR	CALGreen Tier 1 EDR Target	lbs CO2 per sqft	PV kW	Total EDR	Total EDR Margin	% Comp Margin	lbs CO2 per sqft	PV kW	On-Bill B/C Ratio	TDV B/C Ratio
1	PG&E	32.5	23	3.0	3.3	21.9	10.6	31.8%	2.4	3.3	0.9	1.6
2	PG&E	25.0	12	2.2	2.8	14.9	10.1	27.3%	1.8	2.9	0.5	1.6
3	PG&E	23.9	10	1.9	2.7	13.9	10.0	27.7%	1.5	2.8	0.4	1.4
4	PG&E	23.1	8	1.9	2.7	13.0	10.1	24.9%	1.5	2.8	0.3	1.5
5	PG&E	22.2	10	1.8	2.6	12.8	9.4	29.7%	1.4	2.6	0.4	1.3
5	PG&E/SoCalGas	22.2	10	1.8	2.6	12.8	9.4	29.7%	1.4	2.6	0.3	1.3
6	SCE/SoCalGas	23.3	10	1.6	2.7	13.6	9.8	20.1%	1.2	2.8	0.8	1.3
7	SDG&E	20.3	5	1.3	2.6	11.1	9.2	9.0%	1.0	2.7	0.1	1.3
8	SCE/SoCalGas	21.3	10	1.4	2.9	12.9	8.4	23.7%	1.1	3.0	0.9	1.3
9	SCE/SoCalGas	24.5	13	1.5	2.9	15.7	8.8	24.7%	1.2	3.0	1.0	1.5
10	SCE/SoCalGas	24.2	10	1.6	3.0	14.6	9.6	27.3%	1.3	3.1	1.0	1.5
10	SDG&E	24.2	10	1.6	3.0	14.6	9.6	27.3%	1.3	3.1	0.6	1.5
11	PG&E	24.6	11	2.1	3.6	15.4	9.2	29.4%	1.8	3.5	0.4	1.5
12	PG&E	25.5	12	2.1	3.0	15.9	9.6	28.9%	1.8	3.0	0.4	1.7
13	PG&E	25.7	11	2.0	3.8	16.1	9.7	28.9%	1.7	3.7	0.4	1.6
14	SCE/SoCalGas	25.3	15	2.3	3.2	16.3	9.0	30.1%	1.8	3.1	1.3	1.7
14	SDG&E	25.3	15	2.3	3.2	16.3	9.0	30.1%	1.8	3.1	1.2	1.7
15	SCE/SoCalGas	22.4	11	1.7	5.4	15.3	7.1	25.1%	1.4	5.1	1.1	1.5
16	PG&E	30.4	22	3.3	2.7	19.9	10.5	32.6%	2.4	2.8	0.9	1.4

">1" = indicates cases where there is both first cost savings and annual utility bill savings.



Table 27: Single Family All-Electric Efficiency Package Cost-Effectiveness Results

CZ	Utility	BASECASE					Non-Preempted							Equipment - Preempted								
		Total EDR	Efficiency EDR	CALGreen Tier 1 EDR Target	lbs CO2 per sqft	PV kW	Total EDR	Efficiency EDR	Efficiency EDR Margin	% Comp Margin	lbs CO2 per sqft	PV kW	On-Bill B/C Ratio	TDV B/C Ratio	Total EDR	Efficiency EDR	Efficiency EDR Margin	% Comp Margin	lbs CO2 per sqft	PV kW	On-Bill B/C Ratio	TDV B/C Ratio
1	PG&E	46.8	68.2	36	1.5	3.3	31.8	53.0	15.2	40.2%	1.0	3.3	1.8	1.7	39.9	61.3	6.9	18.3%	1.3	3.3	2.9	2.7
2	PG&E	32.8	53.7	16	1.1	2.8	27.9	48.7	4.9	20.5%	0.9	2.8	1.2	1.1	27.7	48.5	5.1	21.2%	0.9	2.8	2.3	2.1
3	PG&E	33.1	55.6	14	1.0	2.7	28.5	50.9	4.7	20.6%	0.8	2.7	2.6	2.4	28.7	51.2	4.4	19.6%	0.9	2.7	1.8	1.6
4	PG&E	31.3	52.8	12	1.0	2.7	27.9	49.4	3.4	15.5%	0.9	2.7	1.9	1.8	27.4	48.9	3.9	17.6%	0.9	2.7	1.5	1.5
5	PG&E	32.5	54.2	16	1.0	2.6	28.1	49.9	4.4	19.7%	0.9	2.6	2.6	2.3	28.0	49.8	4.4	20.3%	0.9	2.6	1.9	1.7
5	PG&E/SoCalGas	32.5	54.2	16	1.0	2.6	28.1	49.9	4.4	19.7%	0.9	2.6	2.6	2.3	28.0	49.8	4.4	20.3%	0.9	2.6	1.9	1.7
6	SCE/SoCalGas	29.7	55.8	12	0.9	2.7	27.7	53.8	2.0	10.9%	0.8	2.7	1.3	1.4	26.8	53.0	2.9	16.0%	0.8	2.7	2.2	2.3
7	SDG&E	27.1	55.3	7	0.7	2.6	27.1	55.3	0.0	0.0%	0.7	2.6	-	-	24.8	53.0	2.2	16.9%	0.7	2.6	1.6	1.7
8	SCE/SoCalGas	26.1	51.5	10	0.8	2.9	24.5	49.9	1.6	8.9%	0.8	2.9	0.6	1.2	24.4	49.7	1.8	9.7%	0.8	2.9	2.8	3.0
9	SCE/SoCalGas	28.8	51.9	13	0.9	2.9	26.0	49.1	2.8	12.5%	0.8	2.9	0.8	2.0	25.5	48.6	3.3	14.7%	0.8	2.9	2.1	3.2
10	SCE/SoCalGas	28.8	50.7	11	0.9	3.0	25.7	47.6	3.1	14.0%	0.9	3.0	0.9	1.5	25.3	47.2	3.4	15.5%	0.8	3.0	2.3	3.2
10	SDG&E	28.8	50.7	11	0.9	3.0	25.7	47.6	3.1	14.0%	0.9	3.0	1.1	1.5	25.3	47.2	3.4	15.5%	0.8	3.0	2.6	3.2
11	PG&E	30.0	50.2	12	1.1	3.6	25.4	45.6	4.6	16.2%	1.0	3.6	1.2	1.5	24.1	44.3	5.9	20.8%	0.9	3.6	3.0	3.3
12	PG&E	30.9	50.1	13	1.0	3.0	27.1	46.3	3.8	15.3%	0.9	3.0	0.8	1.1	25.8	45.0	5.1	20.4%	0.9	3.0	2.0	2.5
13	PG&E	30.7	51.5	13	1.1	3.8	25.7	46.4	5.1	17.4%	0.9	3.8	1.1	1.4	24.7	45.4	6.0	20.9%	0.9	3.8	2.9	3.3
14	SCE/SoCalGas	31.3	52.2	16	1.4	3.2	25.7	46.6	5.6	18.9%	1.2	3.2	1.0	1.5	25.3	46.2	6.0	20.5%	1.2	3.2	2.3	3.1
14	SDG&E	31.3	52.2	16	1.4	3.2	25.7	46.6	5.6	18.9%	1.2	3.2	1.3	1.5	25.3	46.2	6.0	20.5%	1.2	3.2	2.9	3.1
15	SCE/SoCalGas	26.2	52.8	8	1.3	5.4	20.6	47.2	5.6	16.8%	1.1	5.4	1.1	1.6	18.9	45.5	7.3	21.8%	1.0	5.4	3.3	4.5
16	PG&E	46.5	64.6	39	1.7	2.7	36.8	54.9	9.7	25.2%	1.4	2.7	1.7	1.7	41.6	59.7	4.9	12.7%	1.6	2.7	2.4	2.3



Table 28: Single Family All-Electric Efficiency &amp; PV-PV/Battery Package Cost-Effectiveness Results

CZ	Utility	BASECASE				Efficiency & PV							Efficiency & PV/Battery						
		Total EDR	CALGreen Tier 1 EDR Target	lbs CO2 per sqft	PV kW	Total EDR	Total EDR Margin	% Comp Margin	lbs CO2 per sqft	PV kW	On-Bill B/C Ratio	TDV B/C Ratio	Total EDR	Total EDR Margin	% Comp Margin	lbs CO2 per sqft	PV kW	On-Bill B/C Ratio	TDV B/C Ratio
1	PG&E	46.8	36	1.5	3.3	15.4	31.4	40.2%	0.5	6.0	1.8	1.5	5.6	41.2	51.9%	0.3	6.76	1.4	1.4
2	PG&E	32.8	16	1.1	2.8	13.4	19.4	20.5%	0.5	4.9	1.8	1.4	2.7	30.1	31.5%	0.3	5.51	1.4	1.4
3	PG&E	33.1	14	1.0	2.7	14.6	18.5	20.6%	0.5	4.5	2.2	1.7	3.7	29.3	31.6%	0.2	5.10	1.5	1.6
4	PG&E	31.3	12	1.0	2.7	14.1	17.2	15.5%	0.5	4.5	2.1	1.6	2.8	28.6	26.5%	0.2	5.15	1.5	1.6
5	PG&E	32.5	16	1.0	2.6	14.3	18.2	19.7%	0.5	4.3	2.3	1.8	3.8	28.7	32.7%	0.2	4.84	1.6	1.6
5	PG&E/SoCalGas	32.5	16	1.0	2.6	14.3	18.2	19.7%	0.5	4.3	2.3	1.8	3.8	28.7	32.7%	0.2	4.84	1.6	1.6
6	SCE/SoCalGas	29.7	12	0.9	2.7	15.5	14.3	10.9%	0.6	4.1	1.2	1.5	3.6	26.1	18.9%	0.3	4.68	1.2	1.4
7	SDG&E	27.1	7	0.7	2.6	15.8	11.3	0.7%	0.6	3.7	1.9	1.5	2.9	24.2	6.7%	0.3	4.21	1.3	1.5
8	SCE/SoCalGas	26.1	10	0.8	2.9	15.1	10.9	8.9%	0.6	4.0	1.0	1.5	4.5	21.6	24.9%	0.3	4.54	1.1	1.4
9	SCE/SoCalGas	28.8	13	0.9	2.9	17.3	11.5	12.5%	0.7	4.1	1.1	1.6	7.6	21.3	25.5%	0.4	4.66	1.1	1.5
10	SCE/SoCalGas	28.8	11	0.9	3.0	17.7	11.1	14.0%	0.7	4.2	1.1	1.5	7.6	21.2	27.0%	0.4	4.78	1.1	1.5
10	SDG&E	28.8	11	0.9	3.0	17.7	11.1	14.0%	0.7	4.2	1.7	1.5	7.6	21.2	27.0%	0.4	4.78	1.4	1.5
11	PG&E	30.0	12	1.1	3.6	15.8	14.2	16.2%	0.6	5.4	1.8	1.6	6.8	23.2	29.2%	0.4	6.11	1.5	1.6
12	PG&E	30.9	13	1.0	3.0	15.2	15.7	15.3%	0.5	5.0	1.7	1.4	5.6	25.4	29.3%	0.3	5.62	1.3	1.5
13	PG&E	30.7	13	1.1	3.8	17.3	13.4	17.4%	0.6	5.4	1.7	1.5	8.2	22.5	29.4%	0.4	6.14	1.4	1.5
14	SCE/SoCalGas	31.3	16	1.4	3.2	15.8	15.5	18.9%	0.9	4.8	1.2	1.6	7.4	23.9	30.9%	0.6	5.39	1.4	1.6
14	SDG&E	31.3	16	1.4	3.2	15.8	15.5	18.9%	0.9	4.8	1.8	1.6	7.4	23.9	30.9%	0.6	5.39	1.7	1.6
15	SCE/SoCalGas	26.2	8	1.3	5.4	20.0	6.2	16.8%	1.1	5.5	1.1	1.6	12.7	13.5	27.0%	0.8	6.25	1.2	1.5
16	PG&E	46.5	39	1.7	2.7	19.6	27.0	25.2%	0.9	5.5	2.1	1.6	11.1	35.4	34.3%	0.6	6.17	1.7	1.5

">1" = indicates cases where there is both first cost savings and annual utility bill savings.



## Appendix D – Single Family Measure Summary

**Table 29: Single Family Mixed Fuel Efficiency – Non-Preempted Package Measure Summary**

<u>CZ</u>	<u>Duct</u>	<u>Infiltratio</u>	<u>Wall</u>	<u>Attic</u>	<u>Roof</u>	<u>Glazing</u>	<u>Slab</u>	<u>DHW</u>	<u>HVAC</u>	<u>PV</u>
1	VLLDCS	Code Min	Code Min	Code Min	Code Min	Code Min	R-10 slab insulation	Basic CHW credit (0.7)	0.35 W/cfm	1.0 PV scaling
2	VLLDCS	Code Min	Code Min	Code Min	Code Min	Code Min	R-10 slab insulation	Basic CHW credit (0.7)	0.35 W/cfm	1.0 PV scaling
3	VLLDCS	Code Min	Code Min	Code Min	Code Min	Code Min	R-10 slab insulation	Basic CHW credit (0.7)	0.35 W/cfm	1.0 PV scaling
4	VLLDCS	Code Min	Code Min	Code Min	Code Min	Code Min	R-10 slab insulation	Basic CHW credit (0.7)	0.35 W/cfm	1.0 PV scaling
5	VLLDCS	Code Min	Code Min	Code Min	Code Min	Code Min	R-10 slab insulation	Basic CHW credit (0.7)	0.35 W/cfm	1.0 PV scaling
6	VLLDCS	Code Min	Code Min	Code Min	Code Min	Code Min	Code Min	Basic CHW credit (0.7)	0.35 W/cfm	1.0 PV scaling
7	Code Min	Code Min	Code Min	Code Min	Code Min	Code Min	Code Min	Code Min	Code Min	1.0 PV scaling
8	< 12 ft ducts in attic	Code Min	Code Min	Code Min	Code Min	Code Min	Code Min	Basic CHW credit (0.7)	0.35 W/cfm	1.0 PV scaling
9	VLLDCS	Code Min	Code Min	Code Min	Code Min	Code Min	Code Min	Basic CHW credit (0.7)	0.35 W/cfm	1.0 PV scaling
10	VLLDCS	Code Min	Code Min	Code Min	0.25 solar reflectance	Code Min	R-10 slab insulation	Basic CHW credit (0.7)	0.35 W/cfm	1.0 PV scaling
11	VLLDCS	Code Min	Code Min	R-38 + R-30 attic	0.25 solar reflectance	Code Min	R-10 slab insulation	Basic CHW credit (0.7)	0.35 W/cfm	1.0 PV scaling
12	VLLDCS	Code Min	Code Min	Code Min	0.25 solar reflectance	Code Min	R-10 slab insulation	Basic CHW credit (0.7)	0.35 W/cfm	1.0 PV scaling
13	VLLDCS	Code Min	Code Min	R-38 + R-30 attic	0.25 solar reflectance	Code Min	R-10 slab insulation	Basic CHW credit (0.7)	0.35 W/cfm	1.0 PV scaling
14	VLLDCS	3 ACH50	Code Min	Code Min	0.25 solar reflectance	Code Min	R-10 slab insulation	Basic CHW credit (0.7)	0.35 W/cfm	1.0 PV scaling
15	VLLDCS	Code Min	Code Min	R-38 + R-30 attic	0.25 solar reflectance	Code Min	R-10 slab insulation	Basic CHW credit (0.7)	0.35 W/cfm	1.0 PV scaling
16	VLLDCS	Code Min	Code Min	Code Min	Code Min	0.24/0.50 windows	Code Min	Basic CHW credit (0.7)	0.35 W/cfm	1.0 PV scaling

VLLDCS – Verified Low Leakage Ducts in Conditioned Space



**Table 30: Single Family Mixed Fuel Efficiency – Equipment, Preempted Package Measure Summary**

<u>CZ</u>	<u>Duct</u>	<u>Infiltratio</u>	<u>Wall</u>	<u>Attic</u>	<u>Roof</u>	<u>Glazing</u>	<u>Slab</u>	<u>DHW</u>	<u>HVAC</u>	<u>PV</u>
1	VLLDCS	Code Min	Code Min	Code Min	Code Min	Code Min	Code Min	95 EF, basic compact dist.	96 AFUE, 0.35W/cfm	1.0 PV scaling
2	LLAHU + 2% leakage	Code Min	Code Min	Code Min	Code Min	Code Min	Code Min	95 EF, basic compact dist.	96 AFUE, 0.35W/cfm	1.0 PV scaling
3	VLLDCS	Code Min	Code Min	Code Min	Code Min	Code Min	Code Min	95 EF, basic compact dist.	96 AFUE, 0.35W/cfm	1.0 PV scaling
4	LLAHU + 2% leakage	Code Min	Code Min	Code Min	Code Min	Code Min	Code Min	95 EF, basic compact dist.	96 AFUE, 0.35W/cfm	1.0 PV scaling
5	LLAHU + 2% leakage	Code Min	Code Min	Code Min	Code Min	Code Min	Code Min	95 EF, basic compact dist.	96 AFUE, 0.35W/cfm	1.0 PV scaling
6	Code Min	Code Min	Code Min	Code Min	Code Min	Code Min	Code Min	95 EF, basic compact dist.	92 AFUE, 0.35W/cfm	1.0 PV scaling
7	Code Min	Code Min	Code Min	Code Min	Code Min	Code Min	Code Min	95 EF, basic compact dist.	92 AFUE, 0.35W/cfm	1.0 PV scaling
8	Code Min	Code Min	Code Min	Code Min	Code Min	Code Min	Code Min	95 EF, basic compact dist.	92 AFUE, 0.35W/cfm	1.0 PV scaling
9	Code Min	Code Min	Code Min	Code Min	Code Min	Code Min	Code Min	95 EF, basic compact dist.	16 SEER, 92 AFUE, 0.35W/cfm	1.0 PV scaling
10	LLAHU + 2% leakage	Code Min	Code Min	Code Min	Code Min	Code Min	Code Min	95 EF, basic compact dist.	16 SEER, 92 AFUE, 0.35W/cfm	1.0 PV scaling
11	LLAHU + 2% leakage	Code Min	Code Min	Code Min	Code Min	Code Min	Code Min	95 EF, basic compact dist.	18 SEER, 96 AFUE, 0.35W/cfm	1.0 PV scaling
12	LLAHU + 2% leakage	Code Min	Code Min	Code Min	Code Min	Code Min	Code Min	95 EF, basic compact dist.	16 SEER, 92 AFUE, 0.35W/cfm	1.0 PV scaling
13	VLLDCS	Code Min	Code Min	Code Min	Code Min	Code Min	Code Min	95 EF, basic compact dist.	16 SEER, 92 AFUE, 0.35W/cfm	1.0 PV scaling
14	VLLDCS	Code Min	Code Min	Code Min	Code Min	Code Min	Code Min	95 EF, basic compact dist.	16 SEER, 92 AFUE, 0.35W/cfm	1.0 PV scaling
15	LLAHU + 2% leakage	Code Min	Code Min	Code Min	Code Min	Code Min	Code Min	95 EF, basic compact dist.	16 SEER, 92 AFUE, 0.35W/cfm	1.0 PV scaling
16	VLLDCS	Code Min	Code Min	Code Min	Code Min	Code Min	Code Min	95 EF, basic compact dist.	18 SEER, 96 AFUE, 0.35W/cfm	1.0 PV scaling

LLAHU - Low Leakage Air Handling Unit

VLLDCS – Verified Low Leakage Ducts in Conditioned Space



**Table 31: Single Family Mixed Fuel Efficiency & PV/Battery Package Measure Summary**

CZ	Duct	Infiltration	Wall	Attic	Roof	Glazing	Slab	DHW	HVAC	PV
1	VLLDCS	Code Min	Code Min	Code Min	Code Min	Code Min	R-10 slab insulation	Basic CHW credit (0.7)	0.35 W/cfm	1.0 PV scaling + 5kWh batt
2	VLLDCS	Code Min	Code Min	Code Min	Code Min	Code Min	R-10 slab insulation	Basic CHW credit (0.7)	0.35 W/cfm	1.0 PV scaling + 5kWh batt
3	VLLDCS	Code Min	Code Min	Code Min	Code Min	Code Min	R-10 slab insulation	Basic CHW credit (0.7)	0.35 W/cfm	1.0 PV scaling + 5kWh batt
4	VLLDCS	Code Min	Code Min	Code Min	Code Min	Code Min	R-10 slab insulation	Basic CHW credit (0.7)	0.35 W/cfm	1.0 PV scaling + 5kWh batt
5	VLLDCS	Code Min	Code Min	Code Min	Code Min	Code Min	R-10 slab insulation	Basic CHW credit (0.7)	0.35 W/cfm	1.0 PV scaling + 5kWh batt
6	VLLDCS	Code Min	Code Min	Code Min	Code Min	Code Min	Code Min	Basic CHW credit (0.7)	0.35 W/cfm	1.0 PV scaling + 5kWh batt
7	Code Min	Code Min	Code Min	Code Min	Code Min	Code Min	Code Min	Basic CHW credit (0.7)	Code Min	1.0 PV scaling + 5kWh batt
8	< 12 ft ducts in attic	Code Min	Code Min	Code Min	Code Min	Code Min	Code Min	Basic CHW credit (0.7)	0.35 W/cfm	1.0 PV scaling + 5kWh batt
9	VLLDCS	Code Min	Code Min	Code Min	Code Min	Code Min	Code Min	Basic CHW credit (0.7)	0.35 W/cfm	1.0 PV scaling + 5kWh batt
10	VLLDCS	Code Min	Code Min	Code Min	0.25 solar reflectance	Code Min	R-10 slab insulation	Basic CHW credit (0.7)	0.35 W/cfm	1.0 PV scaling + 5kWh batt
11	VLLDCS	Code Min	Code Min	R-38 + R-30 attic	0.25 solar reflectance	Code Min	R-10 slab insulation	Basic CHW credit (0.7)	0.35 W/cfm	1.0 PV scaling + 5kWh batt
12	VLLDCS	Code Min	Code Min	Code Min	0.25 solar reflectance	Code Min	R-10 slab insulation	Basic CHW credit (0.7)	0.35 W/cfm	1.0 PV scaling + 5kWh batt
13	VLLDCS	Code Min	Code Min	R-38 + R-30 attic	0.25 solar reflectance	Code Min	R-10 slab insulation	Basic CHW credit (0.7)	0.35 W/cfm	1.0 PV scaling + 5kWh batt
14	VLLDCS	3 ACH50	Code Min	Code Min	0.25 solar reflectance	Code Min	R-10 slab insulation	Basic CHW credit (0.7)	0.35 W/cfm	1.0 PV scaling + 5kWh batt
15	VLLDCS	Code Min	Code Min	R-38 + R-30 attic	0.25 solar reflectance	Code Min	R-10 slab insulation	Basic CHW credit (0.7)	0.35 W/cfm	1.0 PV scaling + 5kWh batt
16	VLLDCS	Code Min	Code Min	Code Min	Code Min	0.24/0.50 windows	Code Min	Basic CHW credit (0.7)	0.35 W/cfm	1.0 PV scaling + 5kWh batt

VLLDCS – Verified Low Leakage Ducts in Conditioned Space





**Table 32: Single Family All-Electric Efficiency – Non-Preempted Package Measure Summary**

<b>CZ</b>	<b>Duct</b>	<b>Infiltratio</b>	<b>Wall</b>	<b>Attic</b>	<b>Roof</b>	<b>Glazing</b>	<b>Slab</b>	<b>DHW</b>	<b>HVAC</b>	<b>PV</b>
1	VLLDCS	Code Min	Code Min	R-38 + R-30 attic	Code Min	0.24/0.50 windows	R-10 slab insulation	Code Min	0.45 W/cfm	Std Design PV
2	VLLDCS	Code Min	Code Min	Code Min	Code Min	0.24/0.23 windows	R-10 slab insulation	Code Min	0.45 W/cfm	Std Design PV
3	VLLDCS	Code Min	Code Min	Code Min	Code Min	Code Min	R-10 slab insulation	Code Min	0.45 W/cfm	Std Design PV
4	VLLDCS	Code Min	Code Min	Code Min	Code Min	Code Min	R-10 slab insulation	Code Min	0.45 W/cfm	Std Design PV
5	VLLDCS	Code Min	Code Min	Code Min	Code Min	Code Min	R-10 slab insulation	Code Min	0.45 W/cfm	Std Design PV
6	VLLDCS	Code Min	Code Min	Code Min	Code Min	Code Min	Code Min	Code Min	0.45 W/cfm	Std Design PV
7	Code Min	Code Min	Code Min	Code Min	Code Min	Code Min	Code Min	Code Min	Code Min	Std Design PV
8	VLLDCS	Code Min	Code Min	Code Min	Code Min	Code Min	Code Min	Code Min	0.45 W/cfm	Std Design PV
9	VLLDCS	Code Min	Code Min	Code Min	0.25 solar reflectance	Code Min	Code Min	Code Min	0.45 W/cfm	Std Design PV
10	VLLDCS	Code Min	Code Min	Code Min	0.25 solar reflectance	Code Min	R-10 slab insulation	Code Min	0.45 W/cfm	Std Design PV
11	VLLDCS	Code Min	Code Min	R-38 + R-30 attic	0.25 solar reflectance	Code Min	R-10 slab insulation	Code Min	0.45 W/cfm	Std Design PV
12	VLLDCS	Code Min	Code Min	R-38 + R-30 attic	0.25 solar reflectance	Code Min	R-10 slab insulation	Code Min	0.45 W/cfm	Std Design PV
13	VLLDCS	3 ACH50	Code Min	R-38 + R-30 attic	0.25 solar reflectance	Code Min	R-10 slab insulation	Code Min	0.45 W/cfm	Std Design PV
14	VLLDCS	3 ACH50	Code Min	R-38 + R-30 attic	0.25 solar reflectance	Code Min	R-10 slab insulation	Code Min	0.45 W/cfm	Std Design PV
15	VLLDCS	Code Min	0.043 wall	R-38 + R-30 attic	0.25 solar reflectance	Code Min	R-10 slab insulation	Code Min	0.45 W/cfm	Std Design PV
16	VLLDCS	3 ACH50	Code Min	R-38 + R-30 attic	Code Min	0.24/0.50 windows	Code Min	Code Min	0.45 W/cfm	Std Design PV

VLLDCS – Verified Low Leakage Ducts in Conditioned Space



**Table 33: Single Family All-Electric Efficiency – Equipment, Preempted Package Measure Summary**

<b>CZ</b>	<b>Duct</b>	<b>Infiltratio</b>	<b>Wall</b>	<b>Attic</b>	<b>Roof</b>	<b>Glazing</b>	<b>Slab</b>	<b>DHW</b>	<b>HVAC</b>	<b>PV</b>
1	LLAHU + 2% leakage	Code Min	Code Min	Code Min	Code Min	Code Min	Code Min	NEEA Tier 3 HPWH	18 SEER, 10 HSPF, 0.45W/cfm	Std Design PV
2	LLAHU + 2% leakage	Code Min	Code Min	Code Min	Code Min	Code Min	Code Min	NEEA Tier 3 HPWH	18 SEER, 10 HSPF, 0.45W/cfm	Std Design PV
3	LLAHU + 2% leakage	Code Min	Code Min	Code Min	Code Min	Code Min	Code Min	NEEA Tier 3 HPWH	18 SEER, 10 HSPF, 0.45W/cfm	Std Design PV
4	LLAHU + 2% leakage	Code Min	Code Min	Code Min	Code Min	Code Min	Code Min	NEEA Tier 3 HPWH	18 SEER, 10 HSPF, 0.45W/cfm	Std Design PV
5	LLAHU + 2% leakage	Code Min	Code Min	Code Min	Code Min	Code Min	Code Min	NEEA Tier 3 HPWH	18 SEER, 10 HSPF, 0.45W/cfm	Std Design PV
6	Code Min	Code Min	Code Min	Code Min	Code Min	Code Min	Code Min	NEEA Tier 3 HPWH	16 SEER, 9 HSPF, 0.45W/cfm	Std Design PV
7	Code Min	Code Min	Code Min	Code Min	Code Min	Code Min	Code Min	NEEA Tier 3 HPWH	16 SEER, 9 HSPF, 0.45W/cfm	Std Design PV
8	Code Min	Code Min	Code Min	Code Min	Code Min	Code Min	Code Min	NEEA Tier 3 HPWH	0.45 W/cfm	Std Design PV
9	Code Min	Code Min	Code Min	Code Min	Code Min	Code Min	Code Min	NEEA Tier 3 HPWH	16 SEER, 9 HSPF, 0.45W/cfm	Std Design PV
10	LLAHU + 2% leakage	Code Min	Code Min	Code Min	Code Min	Code Min	Code Min	NEEA Tier 3 HPWH	16 SEER, 9 HSPF, 0.45W/cfm	Std Design PV
11	LLAHU + 2% leakage	Code Min	Code Min	Code Min	Code Min	Code Min	Code Min	NEEA Tier 3 HPWH	18 SEER, 10 HSPF, 0.45W/cfm	Std Design PV
12	LLAHU + 2% leakage	Code Min	Code Min	Code Min	Code Min	Code Min	Code Min	NEEA Tier 3 HPWH	18 SEER, 10 HSPF, 0.45W/cfm	Std Design PV
13	LLAHU + 2% leakage	Code Min	Code Min	Code Min	Code Min	Code Min	Code Min	NEEA Tier 3 HPWH	18 SEER, 10 HSPF, 0.45W/cfm	Std Design PV
14	LLAHU + 2% leakage	Code Min	Code Min	Code Min	Code Min	Code Min	Code Min	NEEA Tier 3 HPWH	18 SEER, 10 HSPF, 0.45W/cfm	Std Design PV
15	LLAHU + 2% leakage	Code Min	Code Min	Code Min	Code Min	Code Min	Code Min	NEEA Tier 3 HPWH	18 SEER, 10 HSPF, 0.45W/cfm	Std Design PV
16	LLAHU + 2% leakage	Code Min	Code Min	Code Min	Code Min	Code Min	Code Min	NEEA Tier 3 HPWH	18 SEER, 10 HSPF, 0.45W/cfm	Std Design PV

LLAHU - Low Leakage Air Handling Unit

VVLDCS – Verified Low Leakage Ducts in Conditioned Space



**Table 34: Single Family All-Electric Efficiency & PV Package Measure Summary**

<b>CZ</b>	<b>Duct</b>	<b>Infiltratio</b>	<b>Wall</b>	<b>Attic</b>	<b>Roof</b>	<b>Glazing</b>	<b>Slab</b>	<b>DHW</b>	<b>HVAC</b>	<b>PV</b>
1	VLLDCS	Code Min	Code Min	R-38 + R-30 attic	Code Min	0.24/0.50 windows	R-10 slab insulation	Code Min	0.45 W/cfm	0.9 PV scaling
2	VLLDCS	Code Min	Code Min	Code Min	Code Min	0.24/0.23 windows	R-10 slab insulation	Code Min	0.45 W/cfm	0.9 PV scaling
3	VLLDCS	Code Min	Code Min	Code Min	Code Min	Code Min	R-10 slab insulation	Code Min	0.45 W/cfm	0.9 PV scaling
4	VLLDCS	Code Min	Code Min	Code Min	Code Min	Code Min	R-10 slab insulation	Code Min	0.45 W/cfm	0.9 PV scaling
5	VLLDCS	Code Min	Code Min	Code Min	Code Min	Code Min	R-10 slab insulation	Code Min	0.45 W/cfm	0.9 PV scaling
6	VLLDCS	Code Min	Code Min	Code Min	Code Min	Code Min	Code Min	Code Min	0.45 W/cfm	0.9 PV scaling
7	Code Min	Code Min	Code Min	Code Min	Code Min	Code Min	Code Min	Code Min	0.45 W/cfm	0.9 PV scaling
8	VLLDCS	Code Min	Code Min	Code Min	Code Min	Code Min	Code Min	Code Min	0.45 W/cfm	0.9 PV scaling
9	VLLDCS	Code Min	Code Min	Code Min	0.25 solar reflectance	Code Min	Code Min	Code Min	0.45 W/cfm	0.9 PV scaling
10	VLLDCS	Code Min	Code Min	Code Min	0.25 solar reflectance	Code Min	R-10 slab insulation	Code Min	0.45 W/cfm	0.9 PV scaling
11	VLLDCS	Code Min	Code Min	R-38 + R-30 attic	0.25 solar reflectance	Code Min	R-10 slab insulation	Code Min	0.45 W/cfm	0.9 PV scaling
12	VLLDCS	Code Min	Code Min	R-38 + R-30 attic	0.25 solar reflectance	Code Min	R-10 slab insulation	Code Min	0.45 W/cfm	0.9 PV scaling
13	VLLDCS	3 ACH50	Code Min	R-38 + R-30 attic	0.25 solar reflectance	Code Min	R-10 slab insulation	Code Min	0.45 W/cfm	0.9 PV scaling
14	VLLDCS	3 ACH50	Code Min	R-38 + R-30 attic	0.25 solar reflectance	Code Min	R-10 slab insulation	Code Min	0.45 W/cfm	0.9 PV scaling
15	VLLDCS	Code Min	0.043 wall	R-38 + R-30 attic	0.25 solar reflectance	Code Min	R-10 slab insulation	Code Min	0.45 W/cfm	0.9 PV scaling
16	VLLDCS	3 ACH50	Code Min	R-38 + R-30 attic	Code Min	0.24/0.50 windows	Code Min	Code Min	0.45 W/cfm	0.9 PV scaling

VLLDCS – Verified Low Leakage Ducts in Conditioned Space



**Table 35: Single Family All-Electric Efficiency & PV/Battery Package Measure Summary**

CZ	Duct	Infiltration	Wall	Attic	Roof	Glazing	Slab	DHW	HVAC	PV
1	VLLDCS	Code Min	Code Min	R-38 + R-30 attic	Code Min	0.24/0.50 windows	R-10 slab insulation	Code Min	0.45 W/cfm	1.0 PV scaling + 5kWh batt
2	VLLDCS	Code Min	Code Min	Code Min	Code Min	0.24/0.23 windows	R-10 slab insulation	Code Min	0.45 W/cfm	1.0 PV scaling + 5kWh batt
3	VLLDCS	Code Min	Code Min	Code Min	Code Min	Code Min	R-10 slab insulation	Code Min	0.45 W/cfm	1.0 PV scaling + 5kWh batt
4	VLLDCS	Code Min	Code Min	Code Min	Code Min	Code Min	R-10 slab insulation	Code Min	0.45 W/cfm	1.0 PV scaling + 5kWh batt
5	VLLDCS	Code Min	Code Min	Code Min	Code Min	Code Min	R-10 slab insulation	Code Min	0.45 W/cfm	1.0 PV scaling + 5kWh batt
6	VLLDCS	Code Min	Code Min	Code Min	Code Min	Code Min	Code Min	Code Min	0.45 W/cfm	1.0 PV scaling + 5kWh batt
7	Code Min	Code Min	Code Min	Code Min	Code Min	Code Min	Code Min	Code Min	0.45 W/cfm	1.0 PV scaling + 5kWh batt
8	VLLDCS	Code Min	Code Min	Code Min	Code Min	Code Min	Code Min	Code Min	0.45 W/cfm	1.0 PV scaling + 5kWh batt
9	VLLDCS	Code Min	Code Min	Code Min	0.25 solar reflectance	Code Min	Code Min	Code Min	0.45 W/cfm	1.0 PV scaling + 5kWh batt
10	VLLDCS	Code Min	Code Min	Code Min	0.25 solar reflectance	Code Min	R-10 slab insulation	Code Min	0.45 W/cfm	1.0 PV scaling + 5kWh batt
11	VLLDCS	Code Min	Code Min	R-38 + R-30 attic	0.25 solar reflectance	Code Min	R-10 slab insulation	Code Min	0.45 W/cfm	1.0 PV scaling + 5kWh batt
12	VLLDCS	Code Min	Code Min	R-38 + R-30 attic	0.25 solar reflectance	Code Min	R-10 slab insulation	Code Min	0.45 W/cfm	1.0 PV scaling + 5kWh batt
13	VLLDCS	3 ACH50	Code Min	R-38 + R-30 attic	0.25 solar reflectance	Code Min	R-10 slab insulation	Code Min	0.45 W/cfm	1.0 PV scaling + 5kWh batt
14	VLLDCS	3 ACH50	Code Min	R-38 + R-30 attic	0.25 solar reflectance	Code Min	R-10 slab insulation	Code Min	0.45 W/cfm	1.0 PV scaling + 5kWh batt
15	VLLDCS	Code Min	0.043 wall (SF); 0.048 wall (MF)	R-38 + R-30 attic	0.25 solar reflectance	Code Min	R-10 slab insulation	Code Min	0.45 W/cfm	1.0 PV scaling + 5kWh batt
16	VLLDCS	3 ACH50	Code Min	R-38 + R-30 attic	Code Min	0.24/0.50 windows	Code Min	Code Min	0.45 W/cfm	1.0 PV scaling + 5kWh batt

VLLDCS – Verified Low Leakage Ducts in Conditioned Space



## Appendix E - Multifamily Detailed Results

Table 36: Multifamily Mixed Fuel Efficiency Package Cost-Effectiveness Results

Climate Zone	Utility	BASECASE					Non-Preempted							Equipment - Preempted								
		Total EDR	Efficiency EDR	CALGreen Tier 1 EDR Target	lbs CO2 per sqft	PV kW per Building	Total EDR	Efficiency EDR	Efficiency EDR Margin	% Comp Margin	lbs CO2 per sqft	PV kW per Building	On-Bill B/C Ratio	TDV B/C Ratio	Total EDR	Efficiency EDR	Efficiency EDR Margin	% Comp Margin	lbs CO2 per sqft	PV kW per Building	On-Bill B/C Ratio	TDV B/C Ratio
01	PG&E	28.6	60.7	23	2.7	15.9	25.1	57.3	3.4	19.3%	2.3	16.0	1.1	1.2	26.4	58.4	2.3	12.2%	2.5	15.9	1.3	1.4
02	PG&E	25.7	56.5	12	2.4	13.9	24.2	54.7	1.8	9.9%	2.3	13.8	1.0	1.7	23.6	54.2	2.3	12.5%	2.2	13.9	1.1	1.5
03	PG&E	24.7	57.8	10	2.1	13.5	24.0	57.2	0.6	4.7%	2.1	13.5	1.0	1.1	23.1	56.2	1.6	11.2%	1.9	13.4	1.1	1.2
04	PG&E	25.5	56.8	8	2.2	13.6	24.3	55.5	1.3	7.7%	2.1	13.5	0.8	1.2	23.8	54.9	1.9	10.9%	2.0	13.5	1.1	1.7
05	PG&E	24.2	57.4	10	2.1	12.6	23.7	56.9	0.5	4.4%	2.0	12.6	1.0	1.0	22.7	55.9	1.5	10.9%	1.9	12.6	1.2	1.3
05	PG&E/SoCalGas	24.2	57.4	10	2.1	12.6	23.7	56.9	0.5	4.4%	2.0	12.6	0.8	1.0	22.7	55.9	1.5	10.9%	1.9	12.6	1.1	1.3
06	SCE/SoCalGas	26.8	63.2	10	2.2	13.9	25.8	61.9	1.3	7.0%	2.1	13.8	0.6	1.5	25.5	61.9	1.3	7.4%	2.0	13.9	1.4	1.7
07	SDG&E	26.8	64.5	5	2.1	13.2	26.1	63.6	0.9	5.3%	2.1	13.1	0.7	2.2	25.0	62.5	2.0	12.2%	2.0	13.2	1.1	1.4
08	SCE/SoCalGas	25.7	61.8	10	2.2	14.6	24.6	60.3	1.5	7.4%	2.1	14.5	0.7	1.4	24.6	60.7	1.1	5.7%	2.0	14.6	1.4	1.7
09	SCE/SoCalGas	26.4	59.7	13	2.2	14.7	25.0	57.9	1.8	8.2%	2.2	14.4	1.5	3.3	24.1	56.9	2.8	12.9%	2.1	14.4	1.7	2.9
10	SCE/SoCalGas	27.0	58.7	10	2.3	15.1	25.7	57.0	1.7	7.7%	2.2	14.9	0.8	1.7	24.7	55.8	2.9	13.0%	2.1	14.8	2.0	3.3
10	SDG&E	27.0	58.7	10	2.3	15.1	25.7	57.0	1.7	7.7%	2.2	14.9	1.1	1.7	24.7	55.8	2.9	13.0%	2.1	14.8	2.6	3.3
11	PG&E	24.5	54.5	11	2.4	16.6	22.3	51.6	2.9	11.9%	2.2	16.3	0.7	1.2	22.2	51.3	3.2	13.2%	2.2	16.1	1.8	3.3
12	PG&E	25.9	55.3	12	2.3	14.9	24.3	53.4	1.9	8.8%	2.2	14.8	1.1	2.2	23.5	52.5	2.8	12.8%	2.1	14.7	1.2	2.2
13	PG&E	26.1	55.9	11	2.3	17.5	23.7	52.8	3.1	12.1%	2.1	17.1	0.6	1.3	23.7	52.5	3.4	13.2%	2.1	16.9	2.0	3.8
14	SCE/SoCalGas	25.6	55.9	15	2.8	14.6	23.1	52.8	3.1	12.8%	2.5	14.3	0.7	1.2	23.2	52.6	3.3	13.3%	2.5	14.2	2.0	3.0
14	SDG&E	25.6	55.9	15	2.8	14.6	23.1	52.8	3.1	12.8%	2.5	14.3	0.9	1.2	23.2	52.6	3.3	13.3%	2.5	14.2	2.5	3.0
15	SCE/SoCalGas	25.0	59.2	11	2.5	21.6	22.7	55.0	4.2	12.9%	2.4	20.4	1.4	2.3	22.6	54.8	4.4	13.5%	2.3	20.4	>1	>1
16	PG&E	29.4	57.3	22	3.5	13.4	26.6	54.9	2.4	11.3%	3.0	13.7	1.1	1.2	26.9	54.4	2.9	13.1%	3.1	13.2	1.8	2.1

">1" = indicates cases where there is both first cost savings and annual utility bill savings.



**Table 37: Multifamily Mixed Fuel Efficiency & PV/Battery Package Cost-Effectiveness Results**

CZ	Utility	BASECASE				Efficiency & PV/Battery						
		Total EDR	CALGreen Tier 1 EDR Target	lbs CO2 per sqft	PV kW per Building	Total EDR	Total EDR Margin	% Comp Margin	lbs CO2 per sqft	PV kW per Building	On-Bill B/C Ratio	TDV B/C Ratio
01	PG&E	28.6	23	2.7	15.9	17.1	11.5	29.3%	2.1	16.5	0.4	1.2
02	PG&E	25.7	12	2.4	13.9	14.8	10.9	16.9%	2.1	14.2	0.2	1.6
03	PG&E	24.7	10	2.1	13.5	14.4	10.3	10.7%	1.9	13.9	0.1	1.4
04	PG&E	25.5	8	2.2	13.6	14.3	11.2	15.7%	1.9	13.9	0.2	1.6
05	PG&E	24.2	10	2.1	12.6	14.3	9.9	9.4%	1.8	13.1	0.2	1.4
05	PG&E/SoCalGas	24.2	10	2.1	12.6	14.3	9.9	9.4%	1.8	13.1	0.1	1.4
06	SCE/SoCalGas	26.8	10	2.2	13.9	16.1	10.7	10.0%	1.8	14.2	0.6	1.4
07	SDG&E	26.8	5	2.1	13.2	15.8	11.0	7.3%	1.7	13.6	0.0	1.4
08	SCE/SoCalGas	25.7	10	2.2	14.6	15.8	9.9	13.4%	1.8	14.9	0.7	1.3
09	SCE/SoCalGas	26.4	13	2.2	14.7	16.7	9.7	15.2%	1.8	14.9	0.9	1.5
10	SCE/SoCalGas	27.0	10	2.3	15.1	16.6	10.4	13.7%	1.9	15.3	1.0	1.6
10	SDG&E	27.0	10	2.3	15.1	16.6	10.4	13.7%	1.9	15.3	0.2	1.6
11	PG&E	24.5	11	2.4	16.6	14.0	10.5	19.9%	2.0	16.7	0.4	1.6
12	PG&E	25.9	12	2.3	14.9	15.6	10.3	17.8%	2.0	15.2	0.3	1.7
13	PG&E	26.1	11	2.3	17.5	15.4	10.7	20.1%	2.0	17.5	0.4	1.6
14	SCE/SoCalGas	25.6	15	2.8	14.6	16.0	9.6	20.8%	2.2	14.7	1.1	1.4
14	SDG&E	25.6	15	2.8	14.6	16.0	9.6	20.8%	2.2	14.7	0.5	1.4
15	SCE/SoCalGas	25.0	11	2.5	21.6	16.2	8.8	18.9%	2.1	20.9	1.3	1.7
16	PG&E	29.4	22	3.5	13.4	19.5	9.9	19.3%	2.7	14.1	0.5	1.3

"inf" = indicates cases where there is both first cost savings and annual utility bill savings.



Table 38: Multifamily All-Electric Efficiency Package Cost-Effectiveness Results

CZ	Utility	BASECASE					Non-Preempted							Equipment - Preempted								
		Total EDR	Efficiency EDR	CALGreen Tier 1 EDR Target	lbs CO2 per sqft	PV kW per Building	Total EDR	Efficiency EDR	Efficiency EDR Margin	% Comp Margin	lbs CO2 per sqft	PV kW per Building	On-Bill B/C Ratio	TDV B/C Ratio	Total EDR	Efficiency EDR	Efficiency EDR Margin	% Comp Margin	lbs CO2 per sqft	PV kW per Building	On-Bill B/C Ratio	TDV B/C Ratio
01	PG&E	41.1	70.6	36	1.6	15.9	37.5	67.0	3.6	14.6%	1.5	15.9	1.6	1.4	37.1	67.3	3.3	18.4%	1.4	15.9	2.4	2.3
02	PG&E	34.3	63.4	16	1.4	13.9	32.4	61.5	1.9	9.1%	1.3	13.9	1.7	2.1	31.1	60.2	3.2	15.1%	1.3	13.9	1.6	1.6
03	PG&E	33.5	64.2	14	1.3	13.5	33.5	64.2	0.0	0.0%	1.3	13.5	-	-	30.4	61.5	2.7	19.5%	1.1	13.5	1.7	1.6
04	PG&E	32.0	61.4	12	1.3	13.6	30.5	60.0	1.4	8.0%	1.2	13.6	1.4	1.5	29.7	59.2	2.2	12.2%	1.2	13.6	1.2	1.1
05	PG&E	34.7	65.4	16	1.3	12.6	34.1	64.8	0.6	3.4%	1.3	12.6	1.1	0.9	30.6	61.8	3.6	23.5%	1.2	12.6	2.1	2.0
05	PG&E/SoCalGas	34.7	65.4	16	1.3	12.6	34.1	64.8	0.6	3.4%	1.3	12.6	1.1	0.9	30.6	61.8	3.6	23.5%	1.2	12.6	2.1	2.0
06	SCE/SoCalGas	31.9	65.9	12	1.3	13.9	30.9	64.9	1.0	5.9%	1.3	13.9	0.7	1.3	29.8	63.7	2.2	13.0%	1.2	13.9	1.6	1.9
07	SDG&E	31.7	66.6	7	1.2	13.2	31.1	66.0	0.6	4.6%	1.2	13.2	0.6	1.0	29.7	64.7	1.9	13.6%	1.1	13.2	1.6	1.7
08	SCE/SoCalGas	29.8	63.6	10	1.3	14.6	28.6	62.4	1.2	6.5%	1.2	14.6	0.9	1.7	27.9	61.7	1.9	10.3%	1.2	14.6	1.6	1.8
09	SCE/SoCalGas	30.4	61.9	13	1.3	14.7	28.7	60.3	1.6	8.1%	1.3	14.7	1.3	2.7	28.8	60.4	1.5	7.4%	1.2	14.7	1.6	1.6
10	SCE/SoCalGas	31.2	61.3	11	1.4	15.1	29.3	59.5	1.8	8.7%	1.3	15.1	1.2	2.0	29.3	59.5	1.8	8.6%	1.3	15.1	1.7	2.0
10	SDG&E	31.2	61.3	11	1.4	15.1	29.3	59.5	1.8	8.7%	1.3	15.1	1.5	2.0	29.3	59.5	1.8	8.6%	1.3	15.1	2.0	2.0
11	PG&E	31.9	60.6	12	1.4	16.6	28.5	57.1	3.5	13.1%	1.3	16.6	1.4	1.6	28.1	56.7	3.9	14.4%	1.3	16.6	2.0	2.3
12	PG&E	32.0	59.9	13	1.3	14.9	29.4	57.3	2.6	11.4%	1.2	14.9	0.9	1.1	29.0	57.0	2.9	13.0%	1.2	14.9	1.6	1.6
13	PG&E	32.1	60.5	13	1.4	17.5	28.8	57.2	3.3	12.6%	1.2	17.5	1.3	1.6	28.3	56.7	3.8	14.3%	1.2	17.5	2.0	2.3
14	SCE/SoCalGas	32.5	61.6	16	1.7	14.6	28.9	57.9	3.7	13.8%	1.6	14.6	1.2	1.6	28.7	57.8	3.8	14.3%	1.6	14.6	1.6	2.2
14	SDG&E	32.5	61.6	16	1.7	14.6	28.9	57.9	3.7	13.8%	1.6	14.6	1.5	1.6	28.7	57.8	3.8	14.3%	1.6	14.6	2.0	2.2
15	SCE/SoCalGas	28.2	61.0	8	1.8	21.6	23.9	56.6	4.4	14.2%	1.6	21.6	1.5	2.3	21.9	54.6	6.4	20.6%	1.5	21.6	1.2	1.7
16	PG&E	40.2	66.6	39	1.9	13.4	36.2	62.5	4.1	15.0%	1.7	13.4	2.1	2.1	37.1	63.4	3.2	11.4%	1.7	13.4	1.6	1.7

">1" = indicates cases where there is both first cost savings and annual utility bill savings.



Table 39: Multifamily All-Electric Efficiency &amp; PV-PV/Battery Package Cost-Effectiveness Results

Climate Zone	Utility	BASECASE				Efficiency & PV							Efficiency & PV/Battery						
		Total EDR	CALGreen Tier 1 EDR Target	lbs CO2 per sqft	PV kW per Building	Total EDR	Total EDR Margin	% Comp Margin	lbs CO2 per sqft	PV kW per Building	On-Bill B/C Ratio	TDV B/C Ratio	Total EDR	Total EDR Margin	% Comp Margin	lbs CO2 per sqft	PV kW per Building	On-Bill B/C Ratio	TDV B/C Ratio
01	PG&E	41.1	36	1.6	15.9	18.6	22.5	14.6%	0.8	26.9	2.0	1.5	6.6	34.5	24.6%	0.4	30.3	1.3	1.4
02	PG&E	34.3	16	1.4	13.9	16.8	17.5	9.1%	0.7	21.9	2.4	1.8	3.4	30.9	16.1%	0.3	24.8	1.4	1.7
03	PG&E	33.5	14	1.3	13.5	17.4	16.1	2.6%	0.7	20.8	2.4	1.7	4.0	29.5	8.6%	0.3	23.6	1.3	1.6
04	PG&E	32.0	12	1.3	13.6	17.0	15.0	8.0%	0.7	20.2	2.4	1.8	3.1	28.9	16.0%	0.3	22.9	1.30	1.77
05	PG&E	34.7	16	1.3	12.6	17.6	17.1	3.4%	0.7	19.9	2.5	1.8	4.4	30.3	8.4%	0.3	22.5	1.4	1.7
05	PG&E/SoCalGas	34.7	16	1.3	12.6	17.6	17.1	3.4%	0.7	19.9	2.5	1.8	4.4	30.3	8.4%	0.3	22.5	1.4	1.7
06	SCE/SoCalGas	31.9	12	1.3	13.9	18.1	13.8	5.9%	1.0	19.5	1.2	1.7	4.4	27.5	8.9%	0.5	22.1	1.2	1.6
07	SDG&E	31.7	7	1.2	13.2	18.9	12.8	4.6%	0.9	18.1	2.1	1.8	4.6	27.1	6.6%	0.5	20.5	1.2	1.6
08	SCE/SoCalGas	29.8	10	1.3	14.6	18.2	11.6	6.5%	1.0	19.4	1.3	1.8	5.6	24.2	12.5%	0.5	22.0	1.2	1.6
09	SCE/SoCalGas	30.4	13	1.3	14.7	19.1	11.3	8.1%	1.0	19.4	1.3	1.9	7.1	23.3	15.1%	0.6	22.0	1.3	1.7
10	SCE/SoCalGas	31.2	11	1.4	15.1	20.4	10.8	8.7%	1.1	19.9	1.3	1.8	7.9	23.3	14.7%	0.6	22.5	1.3	1.7
10	SDG&E	31.2	11	1.4	15.1	20.4	10.8	8.7%	1.1	19.9	2.1	1.8	7.9	23.3	14.7%	0.6	22.5	1.4	1.7
11	PG&E	31.9	12	1.4	16.6	18.5	13.4	13.1%	0.8	22.8	2.2	1.8	6.6	25.3	21.1%	0.4	25.8	1.4	1.8
12	PG&E	32.0	13	1.3	14.9	17.6	14.4	11.4%	0.7	21.7	2.1	1.6	5.4	26.6	20.4%	0.4	24.5	1.3	1.7
13	PG&E	32.1	13	1.4	17.5	19.9	12.2	12.6%	0.8	23.3	2.1	1.7	8.2	23.9	20.6%	0.4	26.4	1.4	1.7
14	SCE/SoCalGas	32.5	16	1.7	14.6	18.5	14.0	13.8%	1.3	20.2	1.4	1.9	7.7	24.8	21.8%	0.8	22.8	1.4	1.8
14	SDG&E	32.5	16	1.7	14.6	18.5	14.0	13.8%	1.3	20.2	2.2	1.9	7.7	24.8	21.8%	0.8	22.8	1.7	1.8
15	SCE/SoCalGas	28.2	8	1.8	21.6	21.1	7.1	14.2%	1.5	23.6	1.4	2.1	11.3	16.9	20.2%	1.1	26.6	1.3	1.8
16	PG&E	40.2	39	1.9	13.4	20.6	19.6	15.0%	1.2	22.0	2.6	1.9	10.3	29.9	23.0%	0.8	24.8	1.6	1.7

">1" = indicates cases where there is both first cost savings and annual utility bill savings.





## Appendix F – Multifamily Measure Summary

**Table 40: Multifamily Mixed Fuel Efficiency – Non-Preempted Package Measure Summary**

CZ	Duct	Infiltration	Wall	Attic	Roof	Glazing	Slab	DHW	HVAC	PV
1	VLLDCS	Code Min	Code Min	Code Min	Code Min	0.24/0.50 windows	R-10 slab insulation	Basic CHW credit (0.7)	0.35 W/cfm	1.0 PV scaling
2	VLLDCS	Code Min	Code Min	Code Min	0.25 solar reflectance	Code Min	R-10 slab insulation	Basic CHW credit (0.7)	0.35 W/cfm	1.0 PV scaling
3	Code Min	Code Min	Code Min	Code Min	Code Min	Code Min	R-10 slab insulation	Basic CHW credit (0.7)	0.35 W/cfm	1.0 PV scaling
4	VLLDCS	Code Min	Code Min	Code Min	0.25 solar reflectance	Code Min	R-10 slab insulation	Basic CHW credit (0.7)	0.35 W/cfm	1.0 PV scaling
5	Code Min	Code Min	Code Min	Code Min	Code Min	Code Min	R-10 slab insulation	Basic CHW credit (0.7)	0.35 W/cfm	1.0 PV scaling
6	VLLDCS	Code Min	Code Min	Code Min	0.25 solar reflectance	Code Min	Code Min	Basic CHW credit (0.7)	0.35 W/cfm	1.0 PV scaling
7	Code Min	Code Min	Code Min	Code Min	0.25 solar reflectance	Code Min	Code Min	Basic CHW credit (0.7)	0.35 W/cfm	1.0 PV scaling
8	VLLDCS	Code Min	Code Min	Code Min	0.25 solar reflectance	Code Min	Code Min	Enh CHW credit (0.6)	0.35 W/cfm	1.0 PV scaling
9	VLLDCS	Code Min	Code Min	Code Min	0.25 solar reflectance	Code Min	Code Min	Basic CHW credit (0.7)	0.35 W/cfm	1.0 PV scaling
10	VLLDCS	Code Min	Code Min	Code Min	0.25 solar reflectance	Code Min	R-10 slab insulation	Basic CHW credit (0.7)	0.35 W/cfm	1.0 PV scaling
11	VLLDCS	Code Min	Code Min	Code Min	0.25 solar reflectance	0.24/0.23 windows	R-10 slab insulation	Basic CHW credit (0.7)	0.35 W/cfm	1.0 PV scaling
12	VLLDCS	Code Min	Code Min	Code Min	0.25 solar reflectance	Code Min	R-10 slab insulation	Basic CHW credit (0.7)	0.35 W/cfm	1.0 PV scaling
13	VLLDCS	Code Min	Code Min	Code Min	0.25 solar reflectance	0.24/0.23 windows	R-10 slab insulation	Basic CHW credit (0.7)	0.35 W/cfm	1.0 PV scaling
14	VLLDCS	Code Min	Code Min	Code Min	0.25 solar reflectance	0.24/0.23 windows	R-10 slab insulation	Basic CHW credit (0.7)	0.35 W/cfm	1.0 PV scaling
15	VLLDCS	Code Min	Code Min	Code Min	0.25 solar reflectance	0.24/0.23 windows	R-10 slab insulation	Basic CHW credit (0.7)	0.35 W/cfm	1.0 PV scaling
16	VLLDCS	Code Min	Code Min	Code Min	Code Min	0.24/0.50 windows	R-10 slab insulation	Basic CHW credit (0.7)	0.35 W/cfm	1.0 PV scaling

VLLDCS – Verified Low-Leakage Ducts in Conditioned Space



**Table 41: Multifamily Mixed Fuel Efficiency – Equipment, Preempted Package Measure Summary**

CZ	Duct	Infiltratio	Wall	Attic	Roof	Glazing	Slab	DHW	HVAC	PV
1	Code Min	Code Min	Code Min	Code Min	Code Min	Code Min	Code Min	95 EF, basic compact dist.	16 SEER, 92 AFUE, 0.35W/cfm	1.0 PV scaling
2	Code Min	Code Min	Code Min	Code Min	Code Min	Code Min	Code Min	95 EF, basic compact dist.	16 SEER, 92 AFUE, 0.35W/cfm	1.0 PV scaling
3	Code Min	Code Min	Code Min	Code Min	Code Min	Code Min	Code Min	95 EF, basic compact dist.	92 AFUE, 0.35W/cfm	1.0 PV scaling
4	Code Min	Code Min	Code Min	Code Min	Code Min	Code Min	Code Min	95 EF, basic compact dist.	16 SEER, 0.35 W/cfm	1.0 PV scaling
5	Code Min	Code Min	Code Min	Code Min	Code Min	Code Min	Code Min	95 EF, basic compact dist.	92 AFUE, 0.45W/cfm	1.0 PV scaling
6	Code Min	Code Min	Code Min	Code Min	Code Min	Code Min	Code Min	95 EF, basic compact dist.	Code Min	1.0 PV scaling
7	Code Min	Code Min	Code Min	Code Min	Code Min	Code Min	Code Min	95 EF, basic compact dist.	16 SEER, 0.35 W/cfm	1.0 PV scaling
8	Code Min	Code Min	Code Min	Code Min	Code Min	Code Min	Code Min	95 EF, basic compact dist.	Code Min	1.0 PV scaling
9	Code Min	Code Min	Code Min	Code Min	Code Min	Code Min	Code Min	95 EF, basic compact dist.	16 SEER, 0.35 W/cfm	1.0 PV scaling
10	Code Min	Code Min	Code Min	Code Min	Code Min	Code Min	Code Min	95 EF, basic compact dist.	16 SEER, 0.35 W/cfm	1.0 PV scaling
11	Code Min	Code Min	Code Min	Code Min	Code Min	Code Min	Code Min	95 EF, basic compact dist.	16 SEER, 92 AFUE, 0.35W/cfm	1.0 PV scaling
12	Code Min	Code Min	Code Min	Code Min	Code Min	Code Min	Code Min	95 EF, basic compact dist.	16 SEER, 92 AFUE, 0.35W/cfm	1.0 PV scaling
13	Code Min	Code Min	Code Min	Code Min	Code Min	Code Min	Code Min	95 EF, basic compact dist.	16 SEER, 92 AFUE, 0.35W/cfm	1.0 PV scaling
14	Code Min	Code Min	Code Min	Code Min	Code Min	Code Min	Code Min	95 EF, basic compact dist.	16 SEER, 92 AFUE, 0.35W/cfm	1.0 PV scaling
15	Code Min	Code Min	Code Min	Code Min	Code Min	Code Min	Code Min	95 EF, basic compact dist.	16 SEER, 0.35 W/cfm	1.0 PV scaling
16	Code Min	Code Min	Code Min	Code Min	Code Min	Code Min	Code Min	95 EF, basic compact dist.	16 SEER, 92 AFUE, 0.35W/cfm	1.0 PV scaling

VLLDCS – Verified Low-Leakage Ducts in Conditioned Space



**Table 42: Multifamily Mixed Fuel Efficiency & PV/Battery Package Measure Summary**

CZ	Duct	Infiltration	Wall	Attic	Roof	Glazing	Slab	DHW	HVAC	PV
1	VLLDCS	Code Min	Code Min	Code Min	Code Min	0.24/0.50 windows	R-10 slab insulation	Basic CHW credit (0.7)	0.35 W/cfm	1.0 PV scaling + 22kWh batt
2	VLLDCS	Code Min	Code Min	Code Min	0.25 solar reflectance	Code Min	R-10 slab insulation	Basic CHW credit (0.7)	0.35 W/cfm	1.0 PV scaling + 22kWh batt
3	Code Min	Code Min	Code Min	Code Min	Code Min	Code Min	R-10 slab insulation	Basic CHW credit (0.7)	0.35 W/cfm	1.0 PV scaling + 22kWh batt
4	VLLDCS	Code Min	Code Min	Code Min	0.25 solar reflectance	Code Min	R-10 slab insulation	Basic CHW credit (0.7)	0.35 W/cfm	1.0 PV scaling + 22kWh batt
5	Code Min	Code Min	Code Min	Code Min	Code Min	Code Min	R-10 slab insulation	Basic CHW credit (0.7)	0.35 W/cfm	1.0 PV scaling + 22kWh batt
6	VLLDCS	Code Min	Code Min	Code Min	0.25 solar reflectance	Code Min	Code Min	Basic CHW credit (0.7)	0.35 W/cfm	1.0 PV scaling + 22kWh batt
7	Code Min	Code Min	Code Min	Code Min	0.25 solar reflectance	Code Min	Code Min	Basic CHW credit (0.7)	0.35 W/cfm	1.0 PV scaling + 22kWh batt
8	VLLDCS	Code Min	Code Min	Code Min	0.25 solar reflectance	Code Min	Code Min	Enh CHW credit (0.6)	0.35 W/cfm	1.0 PV scaling + 22kWh batt
9	VLLDCS	Code Min	Code Min	Code Min	0.25 solar reflectance	Code Min	Code Min	Basic CHW credit (0.7)	0.35 W/cfm	1.0 PV scaling + 22kWh batt
10	VLLDCS	Code Min	Code Min	Code Min	0.25 solar reflectance	Code Min	R-10 slab insulation	Basic CHW credit (0.7)	0.35 W/cfm	1.0 PV scaling + 22kWh batt
11	VLLDCS	Code Min	Code Min	Code Min	0.25 solar reflectance	0.24/0.23 windows	R-10 slab insulation	Basic CHW credit (0.7)	0.35 W/cfm	1.0 PV scaling + 22kWh batt
12	VLLDCS	Code Min	Code Min	Code Min	0.25 solar reflectance	Code Min	R-10 slab insulation	Basic CHW credit (0.7)	0.35 W/cfm	1.0 PV scaling + 22kWh batt
13	VLLDCS	Code Min	Code Min	Code Min	0.25 solar reflectance	0.24/0.23 windows	R-10 slab insulation	Basic CHW credit (0.7)	0.35 W/cfm	1.0 PV scaling + 22kWh batt
14	VLLDCS	Code Min	Code Min	Code Min	0.25 solar reflectance	0.24/0.23 windows	R-10 slab insulation	Basic CHW credit (0.7)	0.35 W/cfm	1.0 PV scaling + 22kWh batt
15	VLLDCS	Code Min	Code Min	Code Min	0.25 solar reflectance	0.24/0.23 windows	R-10 slab insulation	Basic CHW credit (0.7)	0.35 W/cfm	1.0 PV scaling + 22kWh batt
16	VLLDCS	Code Min	Code Min	Code Min	Code Min	0.24/0.50 windows	R-10 slab insulation	Basic CHW credit (0.7)	0.35 W/cfm	1.0 PV scaling + 22kWh batt

VLLDCS – Verified Low-Leakage Ducts in Conditioned Space



**Table 43: Multifamily All-Electric Efficiency – Non-Preempted Package Measure Summary**

<u>CZ</u>	<u>Duct</u>	<u>Infiltration</u>	<u>Wall</u>	<u>Attic</u>	<u>Roof</u>	<u>Glazing</u>	<u>Slab</u>	<u>DHW</u>	<u>HVAC</u>	<u>PV</u>
1	VLLDCS	Code Min	Code Min	Code Min	Code Min	0.24/0.50 windows	R-10 slab insulation	Code Min	0.45 W/cfm	Std Design PV
2	VLLDCS	Code Min	Code Min	Code Min	0.25 solar reflectance	Code Min	R-10 slab insulation	Code Min	0.45 W/cfm	Std Design PV
3	Code Min	Code Min	Code Min	Code Min	Code Min	Code Min	Code Min	Code Min	Code Min	Std Design PV
4	VLLDCS	Code Min	Code Min	Code Min	0.25 solar reflectance	Code Min	R-10 slab insulation	Code Min	0.45 W/cfm	Std Design PV
5	VLLDCS	Code Min	Code Min	Code Min	Code Min	Code Min	R-10 slab insulation	Code Min	Code Min	Std Design PV
6	VLLDCS	Code Min	Code Min	Code Min	0.25 solar reflectance	Code Min	Code Min	Code Min	0.45 W/cfm	Std Design PV
7	Code Min	Code Min	Code Min	Code Min	0.25 solar reflectance	Code Min	Code Min	Code Min	0.45 W/cfm	Std Design PV
8	VLLDCS	Code Min	Code Min	Code Min	0.25 solar reflectance	Code Min	Code Min	Code Min	0.45 W/cfm	Std Design PV
9	VLLDCS	Code Min	Code Min	Code Min	0.25 solar reflectance	Code Min	Code Min	Code Min	0.45 W/cfm	Std Design PV
10	VLLDCS	Code Min	Code Min	Code Min	0.25 solar reflectance	Code Min	R-10 slab insulation	Code Min	0.45 W/cfm	Std Design PV
11	VLLDCS	Code Min	Code Min	Code Min	0.25 solar reflectance	0.24/0.23 windows	R-10 slab insulation	Code Min	0.45 W/cfm	Std Design PV
12	VLLDCS	Code Min	Code Min	Code Min	0.25 solar reflectance	0.24/0.23 windows	R-10 slab insulation	Code Min	0.45 W/cfm	Std Design PV
13	VLLDCS	Code Min	Code Min	Code Min	0.25 solar reflectance	0.24/0.23 windows	R-10 slab insulation	Code Min	0.45 W/cfm	Std Design PV
14	VLLDCS	Code Min	Code Min	Code Min	0.25 solar reflectance	0.24/0.23 windows	R-10 slab insulation	Code Min	0.45 W/cfm	Std Design PV
15	VLLDCS	Code Min	Code Min	Code Min	0.25 solar reflectance	0.24/0.23 windows	R-10 slab insulation	Code Min	0.45 W/cfm	Std Design PV
16	VLLDCS	Code Min	Code Min	Code Min	Code Min	0.24/0.50 windows	R-10 slab insulation	Code Min	0.45 W/cfm	Std Design PV

VLLDCS – Verified Low-Leakage Ducts in Conditioned Space



**Table 44: Multifamily All-Electric Efficiency – Equipment, Preempted Package Measure Summary**

<b>CZ</b>	<b>Duct</b>	<b>Infiltratio</b>	<b>Wall</b>	<b>Attic</b>	<b>Roof</b>	<b>Glazing</b>	<b>Slab</b>	<b>DHW</b>	<b>HVAC</b>	<b>PV</b>
1	Code Min	Code Min	Code Min	Code Min	Code Min	Code Min	Code Min	NEEA Tier 3 HPWH	16 SEER, 9 HSPF, 0.45W/cfm	Std Design PV
2	Code Min	Code Min	Code Min	Code Min	Code Min	Code Min	Code Min	NEEA Tier 3 HPWH	16 SEER, 9 HSPF, 0.45W/cfm	Std Design PV
3	Code Min	Code Min	Code Min	Code Min	Code Min	Code Min	Code Min	NEEA Tier 3 HPWH	16 SEER, 9 HSPF, 0.45W/cfm	Std Design PV
4	Code Min	Code Min	Code Min	Code Min	Code Min	Code Min	Code Min	NEEA Tier 3 HPWH	16 SEER, 9 HSPF, 0.45W/cfm	Std Design PV
5	Code Min	Code Min	Code Min	Code Min	Code Min	Code Min	Code Min	NEEA Tier 3 HPWH	16 SEER, 9 HSPF, 0.45W/cfm	Std Design PV
6	Code Min	Code Min	Code Min	Code Min	Code Min	Code Min	Code Min	NEEA Tier 3 HPWH	0.45 W/cfm	Std Design PV
7	Code Min	Code Min	Code Min	Code Min	Code Min	Code Min	Code Min	NEEA Tier 3 HPWH	0.45 W/cfm	Std Design PV
8	Code Min	Code Min	Code Min	Code Min	Code Min	Code Min	Code Min	NEEA Tier 3 HPWH	0.45 W/cfm	Std Design PV
9	Code Min	Code Min	Code Min	Code Min	Code Min	Code Min	Code Min	NEEA Tier 3 HPWH	0.45 W/cfm	Std Design PV
10	Code Min	Code Min	Code Min	Code Min	Code Min	Code Min	Code Min	NEEA Tier 3 HPWH	0.45 W/cfm	Std Design PV
11	Code Min	Code Min	Code Min	Code Min	Code Min	Code Min	Code Min	NEEA Tier 3 HPWH	16 SEER, 9 HSPF, 0.45W/cfm	Std Design PV
12	Code Min	Code Min	Code Min	Code Min	Code Min	Code Min	Code Min	NEEA Tier 3 HPWH	16 SEER, 9 HSPF, 0.45W/cfm	Std Design PV
13	Code Min	Code Min	Code Min	Code Min	Code Min	Code Min	Code Min	NEEA Tier 3 HPWH	16 SEER, 9 HSPF, 0.45W/cfm	Std Design PV
14	Code Min	Code Min	Code Min	Code Min	Code Min	Code Min	Code Min	NEEA Tier 3 HPWH	16 SEER, 9 HSPF, 0.45W/cfm	Std Design PV
15	Code Min	Code Min	Code Min	Code Min	Code Min	Code Min	Code Min	NEEA Tier 3 HPWH	18 SEER, 10 HSPF, 0.45W/cfm	Std Design PV
16	Code Min	Code Min	Code Min	Code Min	Code Min	Code Min	Code Min	NEEA Tier 3 HPWH	16 SEER, 9 HSPF, 0.45W/cfm	Std Design PV

VLLDCS – Verified Low-Leakage Ducts in Conditioned Space



**Table 45: Multifamily All-Electric Efficiency & PV Package Measure Summary**

CZ	Duct	Infiltration	Wall	Attic	Roof	Glazing	Slab	DHW	HVAC	PV
1	VLLDCS	Code Min	Code Min	Code Min	Code Min	0.24/0.50 windows	R-10 slab insulation	Code Min	0.45 W/cfm	0.9 PV scaling
2	VLLDCS	Code Min	Code Min	Code Min	0.25 solar reflectance	Code Min	R-10 slab insulation	Code Min	0.45 W/cfm	0.9 PV scaling
3	Code Min	Code Min	Code Min	Code Min	Code Min	Code Min	R-10 slab insulation	Code Min	0.45 W/cfm	0.9 PV scaling
4	VLLDCS	Code Min	Code Min	Code Min	0.25 solar reflectance	Code Min	R-10 slab insulation	Code Min	0.45 W/cfm	0.9 PV scaling
5	VLLDCS	Code Min	Code Min	Code Min	Code Min	Code Min	R-10 slab insulation	Code Min	Code Min	0.9 PV scaling
6	VLLDCS	Code Min	Code Min	Code Min	0.25 solar reflectance	Code Min	Code Min	Code Min	0.45 W/cfm	0.9 PV scaling
7	Code Min	Code Min	Code Min	Code Min	0.25 solar reflectance	Code Min	Code Min	Code Min	0.45 W/cfm	0.9 PV scaling
8	VLLDCS	Code Min	Code Min	Code Min	0.25 solar reflectance	Code Min	Code Min	Code Min	0.45 W/cfm	0.9 PV scaling
9	VLLDCS	Code Min	Code Min	Code Min	0.25 solar reflectance	Code Min	Code Min	Code Min	0.45 W/cfm	0.9 PV scaling
10	VLLDCS	Code Min	Code Min	Code Min	0.25 solar reflectance	Code Min	R-10 slab insulation	Code Min	0.45 W/cfm	0.9 PV scaling
11	VLLDCS	Code Min	Code Min	Code Min	0.25 solar reflectance	0.24/0.23 windows	R-10 slab insulation	Code Min	0.45 W/cfm	0.9 PV scaling
12	VLLDCS	Code Min	Code Min	Code Min	0.25 solar reflectance	0.24/0.23 windows	R-10 slab insulation	Code Min	0.45 W/cfm	0.9 PV scaling
13	VLLDCS	Code Min	Code Min	Code Min	0.25 solar reflectance	0.24/0.23 windows	R-10 slab insulation	Code Min	0.45 W/cfm	0.9 PV scaling
14	VLLDCS	Code Min	Code Min	Code Min	0.25 solar reflectance	0.24/0.23 windows	R-10 slab insulation	Code Min	0.45 W/cfm	0.9 PV scaling
15	VLLDCS	Code Min	Code Min	Code Min	0.25 solar reflectance	0.24/0.23 windows	R-10 slab insulation	Code Min	0.45 W/cfm	0.9 PV scaling
16	VLLDCS	Code Min	Code Min	Code Min	Code Min	0.24/0.50 windows	R-10 slab insulation	Code Min	0.45 W/cfm	0.9 PV scaling

VLLDCS – Verified Low-Leakage Ducts in Conditioned Space



**Table 46: Multifamily All-Electric Efficiency & PV/Battery Package Measure Summary**

CZ	Duct	Infiltration	Wall	Attic	Roof	Glazing	Slab	DHW	HVAC	PV
1	VLLDCS	Code Min	Code Min	Code Min	Code Min	0.24/0.50 windows	R-10 slab insulation	Code Min	0.45 W/cfm	1.0 PV scaling + 22kWh batt
2	VLLDCS	Code Min	Code Min	Code Min	0.25 solar reflectance	Code Min	R-10 slab insulation	Code Min	0.45 W/cfm	1.0 PV scaling + 22kWh batt
3	Code Min	Code Min	Code Min	Code Min	Code Min	Code Min	R-10 slab insulation	Code Min	0.45 W/cfm	1.0 PV scaling + 22kWh batt
4	VLLDCS	Code Min	Code Min	Code Min	0.25 solar reflectance	Code Min	R-10 slab insulation	Code Min	0.45 W/cfm	1.0 PV scaling + 22kWh batt
5	VLLDCS	Code Min	Code Min	Code Min	Code Min	Code Min	R-10 slab insulation	Code Min	Code Min	1.0 PV scaling + 22kWh batt
6	VLLDCS	Code Min	Code Min	Code Min	0.25 solar reflectance	Code Min	Code Min	Code Min	0.45 W/cfm	1.0 PV scaling + 22kWh batt
7	Code Min	Code Min	Code Min	Code Min	0.25 solar reflectance	Code Min	Code Min	Code Min	0.45 W/cfm	1.0 PV scaling + 22kWh batt
8	VLLDCS	Code Min	Code Min	Code Min	0.25 solar reflectance	Code Min	Code Min	Code Min	0.45 W/cfm	1.0 PV scaling + 22kWh batt
9	VLLDCS	Code Min	Code Min	Code Min	0.25 solar reflectance	Code Min	Code Min	Code Min	0.45 W/cfm	1.0 PV scaling + 22kWh batt
10	VLLDCS	Code Min	Code Min	Code Min	0.25 solar reflectance	Code Min	R-10 slab insulation	Code Min	0.45 W/cfm	1.0 PV scaling + 22kWh batt
11	VLLDCS	Code Min	Code Min	Code Min	0.25 solar reflectance	0.24/0.23 windows	R-10 slab insulation	Code Min	0.45 W/cfm	1.0 PV scaling + 22kWh batt
12	VLLDCS	Code Min	Code Min	Code Min	0.25 solar reflectance	0.24/0.23 windows	R-10 slab insulation	Code Min	0.45 W/cfm	1.0 PV scaling + 22kWh batt
13	VLLDCS	Code Min	Code Min	Code Min	0.25 solar reflectance	0.24/0.23 windows	R-10 slab insulation	Code Min	0.45 W/cfm	1.0 PV scaling + 22kWh batt
14	VLLDCS	Code Min	Code Min	Code Min	0.25 solar reflectance	0.24/0.23 windows	R-10 slab insulation	Code Min	0.45 W/cfm	1.0 PV scaling + 22kWh batt
15	VLLDCS	Code Min	Code Min	Code Min	0.25 solar reflectance	0.24/0.23 windows	R-10 slab insulation	Code Min	0.45 W/cfm	1.0 PV scaling + 22kWh batt
16	VLLDCS	Code Min	Code Min	Code Min	Code Min	0.24/0.50 windows	R-10 slab insulation	Code Min	0.45 W/cfm	1.0 PV scaling + 22kWh batt

VLLDCS – Verified Low-Leakage Ducts in Conditioned Space



## Appendix G – Results by Climate Zone

Climate Zone 1 .....	80
Climate Zone 2 .....	82
Climate Zone 3 .....	84
Climate Zone 4 .....	86
Climate Zone 5 PG&E .....	88
Climate Zone 5 PG&E/SoCalGas .....	90
Climate Zone 6 .....	92
Climate Zone 7 .....	94
Climate Zone 8 .....	96
Climate Zone 9 .....	98
Climate Zone 10 SCE/SoCalGas .....	100
Climate Zone 10 SDGE .....	102
Climate Zone 11 .....	104
Climate Zone 12 .....	106
Climate Zone 13 .....	108
Climate Zone 14 SCE/SoCalGas .....	110
Climate Zone 14 SDGE .....	112
Climate Zone 15 .....	114
Climate Zone 16 .....	116





**Climate Zone 1**

**Table 47: Single Family Climate Zone 1 Results Summary**

Climate Zone 1 PG&E Single Family		Annual Net kWh	Annual therms	EDR Margin <sup>4</sup>	PV Size Change (kW) <sup>5</sup>	CO2-Equivalent Emissions (lbs/sf)		NPV of Lifetime Incremental Cost (\$)	Benefit to Cost Ratio (B/C)	
						Total	Reduction		On-Bill	TDV
Mixed Fuel <sup>1</sup>	Code Compliant	(0)	581	n/a	n/a	3.00	n/a	n/a	n/a	n/a
	Efficiency-Non-Preempted	(0)	480	5.0	(0.08)	2.51	0.49	\$1,355	3.38	2.82
	Efficiency-Equipment	0	440	6.5	(0.07)	2.32	0.68	\$1,280	4.92	4.10
	Efficiency & PV/Battery	(28)	480	10.5	0.04	2.40	0.60	\$5,311	0.87	1.61
All-Electric <sup>2</sup>	Code Compliant	7,079	0	n/a	n/a	1.51	n/a	n/a	n/a	n/a
	Efficiency-Non-Preempted	4,461	0	15.0	0.00	1.01	0.50	\$7,642	1.79	1.66
	Efficiency-Equipment	5,933	0	6.5	0.00	1.29	0.22	\$2,108	2.94	2.74
	Efficiency & PV	889	0	31.0	2.67	0.52	1.00	\$18,192	1.81	1.45
	Efficiency & PV/Battery	(14)	0	41.0	3.45	0.28	1.23	\$24,770	1.45	1.40
Mixed Fuel to All-Electric <sup>3</sup>	Code Compliant	7,079	0	0.0	0.00	1.51	1.49	(\$5,349)	0.37	0.91
	Efficiency & PV	889	0	31.0	2.67	0.52	2.48	\$12,844	1.43	2.11
	Neutral Cost	5,270	0	8.0	1.35	1.26	1.74	\$0	0.00	1.09
	Min Cost Effectiveness	3,106	0	18.0	2.97	0.95	2.04	(\$6,372)	1.08	>1

<sup>1</sup>All reductions and incremental costs relative to the **mixed fuel** code compliant home.

<sup>2</sup>All reductions and incremental costs relative to the **all-electric** code compliant home.

<sup>3</sup>All reductions and incremental costs relative to the **mixed fuel** code compliant home except the EDR Margins are relative to the Standard Design for each case which is the **all-electric** code compliant home. Incremental costs for these packages reflect the costs used in the On-Bill cost effectiveness methodology. Costs differ for the TDV methodology due to differences in the site gas infrastructure costs (see Section 2.6).

<sup>4</sup>This represents the Efficiency EDR Margin for the Efficiency-Non-Preempted and Efficiency-Equipment packages and Total EDR Margin for the Efficiency & PV, Efficiency & PV/Battery, Neutral Cost, and Min Cost Effectiveness packages.

<sup>5</sup>Positive values indicate an increase in PV capacity relative to the Standard Design.



Table 48: Multifamily Climate Zone 1 Results Summary (Per Dwelling Unit)

Climate Zone 1 PG&E Multifamily		Annual Net kWh	Annual therms	EDR Margin <sup>4</sup>	PV Size Change (kW) <sup>5</sup>	CO2-Equivalent Emissions (lbs/sf)		NPV of Lifetime Incremental Cost (\$)	Benefit to Cost Ratio (B/C)	
						Total	Reduction		On-Bill	TDV
Mixed Fuel <sup>1</sup>	Code Compliant	(0)	180	n/a	n/a	2.75	n/a	n/a	n/a	n/a
	Efficiency-Non-Preempted	(0)	147	3.0	0.00	2.31	0.44	\$960	1.10	1.18
	Efficiency-Equipment	(0)	159	2.0	(0.01)	2.48	0.27	\$507	1.29	1.41
	Efficiency & PV/Battery	(14)	147	11.5	0.07	2.13	0.61	\$3,094	0.35	1.21
All-Electric <sup>2</sup>	Code Compliant	2,624	0	n/a	n/a	1.62	n/a	n/a	n/a	n/a
	Efficiency-Non-Preempted	2,328	0	3.5	0.00	1.46	0.15	\$949	1.55	1.40
	Efficiency-Equipment	2,278	0	3.0	0.00	1.41	0.20	\$795	2.39	2.26
	Efficiency & PV	499	0	22.5	1.37	0.75	0.86	\$5,538	2.04	1.50
	Efficiency & PV/Battery	(7)	0	34.5	1.80	0.38	1.24	\$8,919	1.33	1.43
Mixed Fuel to All-Electric <sup>3</sup>	Code Compliant	2,624	0	0.0	0.00	1.62	1.13	(\$2,337)	0.38	1.01
	Efficiency & PV	62	0	22.5	1.37	0.75	2.00	\$3,202	1.63	>1
	Neutral Cost	1,693	0	9.5	0.70	1.25	1.50	\$0	0.00	1.57
	Min Cost Effectiveness	1,273	0	14.0	1.01	1.09	1.66	(\$1,052)	1.14	3.76

<sup>1</sup>All reductions and incremental costs relative to the **mixed fuel** code compliant home.

<sup>2</sup>All reductions and incremental costs relative to the **all-electric** code compliant home.

<sup>3</sup>All reductions and incremental costs relative to the **mixed fuel** code compliant home except the EDR Margins are relative to the Standard Design for each case which is the **all-electric** code compliant home. Incremental costs for these packages reflect the costs used in the On-Bill cost effectiveness methodology. Costs differ for the TDV methodology due to differences in the site gas infrastructure costs (see Section 2.6).

<sup>4</sup>This represents the Efficiency EDR Margin for the Efficiency-Non-Preempted and Efficiency-Equipment packages and Total EDR Margin for the Efficiency & PV, Efficiency & PV/Battery, Neutral Cost, and Min Cost Effectiveness packages.

<sup>5</sup>Positive values indicate an increase in PV capacity relative to the Standard Design.



**Climate Zone 2**

**Table 49: Single Family Climate Zone 2 Results Summary**

Climate Zone 2 PG&E Single Family		Annual Net kWh	Annual therms	EDR Margin <sup>4</sup>	PV Size Change (kW) <sup>5</sup>	CO2-Equivalent Emissions (lbs/sf)		NPV of Lifetime Incremental Cost (\$)	Benefit to Cost Ratio (B/C)	
						Total	Reduction		On-Bill	TDV
Mixed Fuel <sup>1</sup>	Code Compliant	(0)	421	n/a	n/a	2.23	n/a	n/a	n/a	n/a
	Efficiency-Non-Preempted	0	360	3.0	(0.04)	1.94	0.30	\$1,504	1.63	1.66
	Efficiency-Equipment	(0)	352	3.0	(0.03)	1.90	0.33	\$724	3.77	3.63
	Efficiency & PV/Battery	(22)	360	10.0	0.06	1.82	0.41	\$5,393	0.47	1.56
All-Electric <sup>2</sup>	Code Compliant	5,014	0	n/a	n/a	1.11	n/a	n/a	n/a	n/a
	Efficiency-Non-Preempted	4,079	0	4.5	0.00	0.94	0.18	\$3,943	1.21	1.07
	Efficiency-Equipment	4,122	0	5.0	0.00	0.94	0.17	\$2,108	2.25	2.10
	Efficiency & PV	847	0	19.0	2.07	0.49	0.63	\$12,106	1.83	1.38
	Efficiency & PV/Battery	(15)	0	30.0	2.71	0.26	0.86	\$18,132	1.37	1.43
Mixed Fuel to All-Electric <sup>3</sup>	Code Compliant	5,014	0	0.0	0.00	1.11	1.12	(\$5,349)	0.52	1.59
	Efficiency & PV	847	0	19.0	2.07	0.49	1.75	\$6,758	1.76	39.70
	Neutral Cost	2,891	0	9.5	1.36	0.82	1.41	\$0	>1	>1

<sup>1</sup>All reductions and incremental costs relative to the **mixed fuel** code compliant home.

<sup>2</sup>All reductions and incremental costs relative to the **all-electric** code compliant home.

<sup>3</sup>All reductions and incremental costs relative to the **mixed fuel** code compliant home except the EDR Margins are relative to the Standard Design for each case which is the **all-electric** code compliant home. Incremental costs for these packages reflect the costs used in the On-Bill cost effectiveness methodology. Costs differ for the TDV methodology due to differences in the site gas infrastructure costs (see Section 2.6).

<sup>4</sup>This represents the Efficiency EDR Margin for the Efficiency-Non-Preempted and Efficiency-Equipment packages and Total EDR Margin for the Efficiency & PV, Efficiency & PV/Battery, and Neutral Cost packages.

<sup>5</sup>Positive values indicate an increase in PV capacity relative to the Standard Design.



Table 50: Multifamily Climate Zone 2 Results Summary (Per Dwelling Unit)

Climate Zone 2 PG&E Multifamily		Annual Net kWh	Annual therms	EDR Margin <sup>4</sup>	PV Size Change (kW) <sup>5</sup>	CO2-Equivalent Emissions (lbs/sf)		NPV of Lifetime Incremental Cost (\$)	Benefit to Cost Ratio (B/C)	
						Total	Reduction		On-Bill	TDV
Mixed Fuel <sup>1</sup>	Code Compliant	(0)	150	n/a	n/a	2.37	n/a	n/a	n/a	n/a
	Efficiency-Non-Preempted	0	142	1.5	(0.02)	2.25	0.12	\$309	0.97	1.75
	Efficiency-Equipment	(0)	134	2.0	(0.01)	2.15	0.22	\$497	1.08	1.49
	Efficiency & PV/Battery	(11)	142	10.5	0.04	2.07	0.30	\$2,413	0.17	1.60
All-Electric <sup>2</sup>	Code Compliant	2,151	0	n/a	n/a	1.38	n/a	n/a	n/a	n/a
	Efficiency-Non-Preempted	2,038	0	1.5	0.00	1.32	0.06	\$361	1.73	2.05
	Efficiency-Equipment	1,928	0	3.0	0.00	1.25	0.13	\$795	1.56	1.56
	Efficiency & PV	476	0	17.5	1.00	0.72	0.67	\$3,711	2.42	1.82
	Efficiency & PV/Battery	(7)	0	30.5	1.36	0.35	1.04	\$6,833	1.38	1.74
Mixed Fuel to All-Electric <sup>3</sup>	Code Compliant	2,151	0	0.0	0.00	1.38	0.99	(\$2,337)	0.53	1.42
	Efficiency & PV	60	0	17.5	1.00	0.72	1.65	\$1,375	3.31	>1
	Neutral Cost	1,063	0	10.5	0.70	0.96	1.41	\$0	>1	>1

<sup>1</sup>All reductions and incremental costs relative to the **mixed fuel** code compliant home.

<sup>2</sup>All reductions and incremental costs relative to the **all-electric** code compliant home.

<sup>3</sup>All reductions and incremental costs relative to the **mixed fuel** code compliant home except the EDR Margins are relative to the Standard Design for each case which is the **all-electric** code compliant home. Incremental costs for these packages reflect the costs used in the On-Bill cost effectiveness methodology. Costs differ for the TDV methodology due to differences in the site gas infrastructure costs (see Section 2.6).

<sup>4</sup>This represents the Efficiency EDR Margin for the Efficiency-Non-Preempted and Efficiency-Equipment packages and Total EDR Margin for the Efficiency & PV, Efficiency & PV/Battery, and Neutral Cost packages.

<sup>5</sup>Positive values indicate an increase in PV capacity relative to the Standard Design.



**Climate Zone 3**

**Table 51: Single Family Climate Zone 3 Results Summary**

Climate Zone 3 PG&E Single Family		Annual Net kWh	Annual therms	EDR Margin <sup>4</sup>	PV Size Change (kW) <sup>5</sup>	CO2-Equivalent Emissions (lbs/sf)		NPV of Lifetime Incremental Cost (\$)	Benefit to Cost Ratio (B/C)	
						Total	Reduction		On-Bill	TDV
Mixed Fuel <sup>1</sup>	Code Compliant	(0)	348	n/a	n/a	1.88	n/a	n/a	n/a	n/a
	Efficiency-Non-Preempted	(0)	296	2.5	(0.03)	1.63	0.26	\$1,552	1.28	1.31
	Efficiency-Equipment	(0)	273	4.0	(0.03)	1.52	0.37	\$1,448	1.91	1.97
	Efficiency & PV/Battery	(20)	296	10.0	0.07	1.50	0.38	\$5,438	0.38	1.38
All-Electric <sup>2</sup>	Code Compliant	4,355	0	n/a	n/a	1.00	n/a	n/a	n/a	n/a
	Efficiency-Non-Preempted	3,584	0	4.5	0.00	0.85	0.15	\$1,519	2.60	2.36
	Efficiency-Equipment	3,670	0	4.0	0.00	0.86	0.14	\$2,108	1.76	1.62
	Efficiency & PV	790	0	18.0	1.77	0.46	0.54	\$8,517	2.22	1.68
	Efficiency & PV/Battery	(12)	0	29.0	2.37	0.23	0.76	\$14,380	1.50	1.58
Mixed Fuel to All-Electric <sup>3</sup>	Code Compliant	4,355	0	0.0	0.00	1.00	0.89	(\$5,349)	0.55	1.53
	Efficiency & PV	790	0	18.0	1.77	0.46	1.43	\$3,169	2.88	>1
	Neutral Cost	2,217	0	10.5	1.35	0.70	1.18	\$0	>1	>1

<sup>1</sup>All reductions and incremental costs relative to the **mixed fuel** code compliant home.

<sup>2</sup>All reductions and incremental costs relative to the **all-electric** code compliant home.

<sup>3</sup>All reductions and incremental costs relative to the **mixed fuel** code compliant home except the EDR Margins are relative to the Standard Design for each case which is the **all-electric** code compliant home. Incremental costs for these packages reflect the costs used in the On-Bill cost effectiveness methodology. Costs differ for the TDV methodology due to differences in the site gas infrastructure costs (see Section 2.6).

<sup>4</sup>This represents the Efficiency EDR Margin for the Efficiency-Non-Preempted and Efficiency-Equipment packages and Total EDR Margin for the Efficiency & PV, Efficiency & PV/Battery, and Neutral Cost packages.

<sup>5</sup>Positive values indicate an increase in PV capacity relative to the Standard Design.



Table 52: Multifamily Climate Zone 3 Results Summary (Per Dwelling Unit)

Climate Zone 3 PG&E Multifamily		Annual Net kWh	Annual therms	EDR Margin <sup>4</sup>	PV Size Change (kW) <sup>5</sup>	CO2-Equivalent Emissions (lbs/sf)		NPV of Lifetime Incremental Cost (\$)	Benefit to Cost Ratio (B/C)	
						Total	Reduction		On-Bill	TDV
Mixed Fuel <sup>1</sup>	Code Compliant	(0)	133	n/a	n/a	2.13	n/a	n/a	n/a	n/a
	Efficiency-Non-Preempted	(0)	127	0.5	(0.00)	2.06	0.07	\$175	1.00	1.11
	Efficiency-Equipment	(0)	119	1.5	(0.00)	1.94	0.19	\$403	1.11	1.23
	Efficiency & PV/Battery	(10)	127	10.0	0.05	1.86	0.27	\$2,279	0.11	1.41
All-Electric <sup>2</sup>	Code Compliant	1,944	0	n/a	n/a	1.27	n/a	n/a	n/a	n/a
	Efficiency-Non-Preempted	1,944	0	0.0	0.00	1.27	0.00	\$0	-	-
	Efficiency-Equipment	1,698	0	2.5	0.00	1.13	0.14	\$795	1.73	1.58
	Efficiency & PV	457	0	16.0	0.92	0.69	0.58	\$3,272	2.43	1.73
	Efficiency & PV/Battery	(7)	0	29.5	1.26	0.33	0.94	\$6,344	1.32	1.64
Mixed Fuel to All-Electric <sup>3</sup>	Code Compliant	1,944	0	0.0	0.00	1.27	0.86	(\$2,337)	0.58	1.46
	Efficiency & PV	57	0	16.0	0.92	0.69	1.43	\$936	4.18	>1
	Neutral Cost	845	0	11.5	0.70	0.85	1.28	\$0	>1	>1

<sup>1</sup>All reductions and incremental costs relative to the **mixed fuel** code compliant home.

<sup>2</sup>All reductions and incremental costs relative to the **all-electric** code compliant home.

<sup>3</sup>All reductions and incremental costs relative to the **mixed fuel** code compliant home except the EDR Margins are relative to the Standard Design for each case which is the **all-electric** code compliant home. Incremental costs for these packages reflect the costs used in the On-Bill cost effectiveness methodology. Costs differ for the TDV methodology due to differences in the site gas infrastructure costs (see Section 2.6).

<sup>4</sup>This represents the Efficiency EDR Margin for the Efficiency-Non-Preempted and Efficiency-Equipment packages and Total EDR Margin for the Efficiency & PV, Efficiency & PV/Battery, and Neutral Cost packages.

<sup>5</sup>Positive values indicate an increase in PV capacity relative to the Standard Design.



**Climate Zone 4**

**Table 53: Single Family Climate Zone 4 Results Summary**

Climate Zone 4 PG&E Single Family		Annual Net kWh	Annual therms	EDR Margin <sup>4</sup>	PV Size Change (kW) <sup>5</sup>	CO2-Equivalent Emissions (lbs/sf)		NPV of Lifetime Incremental Cost (\$)	Benefit to Cost Ratio (B/C)	
						Total	Reduction		On-Bill	TDV
Mixed Fuel <sup>1</sup>	Code Compliant	0	347	n/a	n/a	1.88	n/a	n/a	n/a	n/a
	Efficiency-Non-Preempted	0	306	2.5	(0.03)	1.68	0.20	\$1,556	0.93	1.15
	Efficiency-Equipment	(0)	294	2.5	(0.02)	1.62	0.26	\$758	2.39	2.67
	Efficiency & PV/Battery	(18)	306	10.0	0.07	1.55	0.33	\$5,434	0.30	1.48
All-Electric <sup>2</sup>	Code Compliant	4,342	0	n/a	n/a	1.00	n/a	n/a	n/a	n/a
	Efficiency-Non-Preempted	3,775	0	3.0	0.00	0.89	0.11	\$1,519	1.92	1.84
	Efficiency-Equipment	3,747	0	3.5	0.00	0.88	0.12	\$2,108	1.52	1.52
	Efficiency & PV	814	0	17.0	1.84	0.48	0.52	\$8,786	2.13	1.62
	Efficiency & PV/Battery	(11)	0	28.5	2.44	0.25	0.75	\$14,664	1.46	1.61
Mixed Fuel to All-Electric <sup>3</sup>	Code Compliant	4,342	0	0.0	0.00	1.00	0.88	(\$5,349)	0.55	1.59
	Efficiency & PV	814	0	17.0	1.84	0.48	1.40	\$3,438	2.64	>1
	Neutral Cost	2,166	0	10.0	1.35	0.70	1.18	\$0	>1	>1

<sup>1</sup>All reductions and incremental costs relative to the **mixed fuel** code compliant home.

<sup>2</sup>All reductions and incremental costs relative to the **all-electric** code compliant home.

<sup>3</sup>All reductions and incremental costs relative to the **mixed fuel** code compliant home except the EDR Margins are relative to the Standard Design for each case which is the **all-electric** code compliant home. Incremental costs for these packages reflect the costs used in the On-Bill cost effectiveness methodology. Costs differ for the TDV methodology due to differences in the site gas infrastructure costs (see Section 2.6).

<sup>4</sup>This represents the Efficiency EDR Margin for the Efficiency-Non-Preempted and Efficiency-Equipment packages and Total EDR Margin for the Efficiency & PV, Efficiency & PV/Battery, and Neutral Cost packages.

<sup>5</sup>Positive values indicate an increase in PV capacity relative to the Standard Design.



Table 54: Multifamily Climate Zone 4 Results Summary (Per Dwelling Unit)

Climate Zone 4 PG&E Multifamily		Annual Net kWh	Annual therms	EDR Margin <sup>4</sup>	PV Size Change (kW) <sup>5</sup>	CO2-Equivalent Emissions (lbs/sf)		NPV of Lifetime Incremental Cost (\$)	Benefit to Cost Ratio (B/C)	
						Total	Reduction		On-Bill	TDV
Mixed Fuel <sup>1</sup>	Code Compliant	(0)	134	n/a	n/a	2.16	n/a	n/a	n/a	n/a
	Efficiency-Non-Preempted	(0)	127	1.0	(0.01)	2.06	0.10	\$329	0.75	1.24
	Efficiency-Equipment	(0)	123	1.5	(0.01)	2.01	0.15	\$351	1.06	1.74
	Efficiency & PV/Battery	(9)	127	11.0	0.04	1.87	0.29	\$2,429	0.17	1.60
All-Electric <sup>2</sup>	Code Compliant	1,887	0	n/a	n/a	1.25	n/a	n/a	n/a	n/a
	Efficiency-Non-Preempted	1,794	0	1.0	0.00	1.21	0.05	\$361	1.38	1.54
	Efficiency-Equipment	1,712	0	2.0	0.00	1.15	0.10	\$795	1.23	1.09
	Efficiency & PV	453	0	15.0	0.83	0.69	0.57	\$3,158	2.43	1.81
	Efficiency & PV/Battery	(7)	0	28.5	1.17	0.32	0.93	\$6,201	1.30	1.77
Mixed Fuel to All-Electric <sup>3</sup>	Code Compliant	1,887	0	0.0	0.00	1.25	0.90	(\$2,337)	0.65	1.77
	Efficiency & PV	57	0	15.0	0.83	0.69	1.47	\$822	4.96	>1
	Neutral Cost	767	0	11.0	0.70	0.82	1.33	\$0	>1	>1

<sup>1</sup>All reductions and incremental costs relative to the **mixed fuel** code compliant home.

<sup>2</sup>All reductions and incremental costs relative to the **all-electric** code compliant home.

<sup>3</sup>All reductions and incremental costs relative to the **mixed fuel** code compliant home except the EDR Margins are relative to the Standard Design for each case which is the **all-electric** code compliant home. Incremental costs for these packages reflect the costs used in the On-Bill cost effectiveness methodology. Costs differ for the TDV methodology due to differences in the site gas infrastructure costs (see Section 2.6).

<sup>4</sup>This represents the Efficiency EDR Margin for the Efficiency-Non-Preempted and Efficiency-Equipment packages and Total EDR Margin for the Efficiency & PV, Efficiency & PV/Battery, and Neutral Cost packages.

<sup>5</sup>Positive values indicate an increase in PV capacity relative to the Standard Design..





**Climate Zone 5 PG&E**

**Table 55: Single Family Climate Zone 5 PG&E Results Summary**

Climate Zone 5 PG&E Single Family		Annual Net kWh	Annual therms	EDR Margin <sup>4</sup>	PV Size Change (kW) <sup>5</sup>	CO2-Equivalent Emissions (lbs/sf)		NPV of Lifetime Incremental Cost (\$)	Benefit to Cost Ratio (B/C)	
						Total	Reduction		On-Bill	TDV
Mixed Fuel <sup>1</sup>	Code Compliant	0	331	n/a	n/a	1.79	n/a	n/a	n/a	n/a
	Efficiency-Non-Preempted	(0)	281	2.5	(0.03)	1.55	0.24	\$1,571	1.10	1.22
	Efficiency-Equipment	(0)	279	2.5	(0.02)	1.54	0.25	\$772	2.29	2.48
	Efficiency & PV/Battery	(14)	281	9.0	0.07	1.43	0.36	\$5,433	0.37	1.32
All-Electric <sup>2</sup>	Code Compliant	4,452	0	n/a	n/a	1.01	n/a	n/a	n/a	n/a
	Efficiency-Non-Preempted	3,687	0	4.0	0.00	0.86	0.15	\$1,519	2.58	2.31
	Efficiency-Equipment	3,737	0	4.0	0.00	0.87	0.14	\$2,108	1.85	1.70
	Efficiency & PV	798	0	18.0	1.72	0.46	0.55	\$8,307	2.31	1.76
	Efficiency & PV/Battery	(8)	0	28.5	2.29	0.24	0.78	\$14,047	1.59	1.63
Mixed Fuel to All-Electric <sup>3</sup>	Code Compliant	4,452	0	0.0	0.00	1.01	0.78	(\$5,349)	0.48	1.32
	Efficiency & PV	798	0	18.0	1.72	0.46	1.33	\$2,959	2.72	>1
	Neutral Cost	2,172	0	11.0	1.35	0.70	1.10	\$0	>1	40.07

<sup>1</sup>All reductions and incremental costs relative to the **mixed fuel** code compliant home.

<sup>2</sup>All reductions and incremental costs relative to the **all-electric** code compliant home.

<sup>3</sup>All reductions and incremental costs relative to the **mixed fuel** code compliant home except the EDR Margins are relative to the Standard Design for each case which is the **all-electric** code compliant home. Incremental costs for these packages reflect the costs used in the On-Bill cost effectiveness methodology. Costs differ for the TDV methodology due to differences in the site gas infrastructure costs (see Section 2.6).

<sup>4</sup>This represents the Efficiency EDR Margin for the Efficiency-Non-Preempted and Efficiency-Equipment packages and Total EDR Margin for the Efficiency & PV, Efficiency & PV/Battery, and Neutral Cost packages.

<sup>5</sup>Positive values indicate an increase in PV capacity relative to the Standard Design.



Table 56: Multifamily Climate Zone 5 PG&E Results Summary (Per Dwelling Unit)

Climate Zone 5 PG&E Multifamily		Annual Net kWh	Annual therms	EDR Margin <sup>4</sup>	PV Size Change (kW) <sup>5</sup>	CO <sub>2</sub> -Equivalent Emissions (lbs/sf)		NPV of Lifetime Incremental Cost (\$)	Benefit to Cost Ratio (B/C)	
						Total	Reduction		On-Bill	TDV
Mixed Fuel <sup>1</sup>	Code Compliant	0	131	n/a	n/a	2.10	n/a	n/a	n/a	n/a
	Efficiency-Non-Preempted	(0)	126	0.5	(0.00)	2.03	0.07	\$180	0.99	1.03
	Efficiency-Equipment	(0)	117	1.5	(0.00)	1.92	0.19	\$358	1.24	1.34
	Efficiency & PV/Battery	(7)	126	9.5	0.05	1.84	0.26	\$2,273	0.15	1.38
All-Electric <sup>2</sup>	Code Compliant	2,044	0	n/a	n/a	1.32	n/a	n/a	n/a	n/a
	Efficiency-Non-Preempted	1,990	0	0.5	0.00	1.30	0.03	\$247	1.09	0.86
	Efficiency-Equipment	1,738	0	3.5	0.00	1.15	0.17	\$795	2.15	2.03
	Efficiency & PV	465	0	17.0	0.91	0.70	0.62	\$3,293	2.53	1.82
	Efficiency & PV/Battery	(6)	0	30.0	1.24	0.34	0.98	\$6,314	1.44	1.69
Mixed Fuel to All-Electric <sup>3</sup>	Code Compliant	2,044	0	0.0	0.00	1.32	0.78	(\$2,337)	0.50	1.28
	Efficiency & PV	58	0	17.0	0.91	0.70	1.40	\$956	3.80	>1
	Neutral Cost	874	0	12.5	0.70	0.87	1.23	\$0	>1	23.44

<sup>1</sup>All reductions and incremental costs relative to the **mixed fuel** code compliant home.

<sup>2</sup>All reductions and incremental costs relative to the **all-electric** code compliant home.

<sup>3</sup>All reductions and incremental costs relative to the **mixed fuel** code compliant home except the EDR Margins are relative to the Standard Design for each case which is the **all-electric** code compliant home. Incremental costs for these packages reflect the costs used in the On-Bill cost effectiveness methodology. Costs differ for the TDV methodology due to differences in the site gas infrastructure costs (see Section 2.6).

<sup>4</sup>This represents the Efficiency EDR Margin for the Efficiency-Non-Preempted and Efficiency-Equipment packages and Total EDR Margin for the Efficiency & PV, Efficiency & PV/Battery, and Neutral Cost packages.

<sup>5</sup>Positive values indicate an increase in PV capacity relative to the Standard Design.



**Climate Zone 5 PG&E/SoCalGas**

**Table 57: Single Family Climate Zone 5 PG&E/SoCalGas Results Summary**

Climate Zone 5 PG&E/SoCalGas Single Family		Annual Net kWh	Annual therms	EDR Margin <sup>4</sup>	PV Size Change (kW) <sup>5</sup>	CO2-Equivalent Emissions (lbs/sf)		NPV of Lifetime Incremental Cost (\$)	Benefit to Cost Ratio (B/C)	
						Total	Reduction		On- Bill	TDV
Mixed Fuel <sup>1</sup>	Code Compliant	0	331	n/a	n/a	1.79	n/a	n/a	n/a	n/a
	Efficiency-Non-Preempted	(0)	281	2.5	(0.03)	1.55	0.24	\$1,571	0.92	1.22
	Efficiency-Equipment	(0)	279	2.5	(0.02)	1.54	0.25	\$772	1.98	2.48
	Efficiency & PV/Battery	(14)	281	9.0	0.07	1.43	0.36	\$5,433	0.31	1.32
All-Electric <sup>2</sup>	Code Compliant	4,452	0	n/a	n/a	1.01	n/a	n/a	n/a	n/a
	Efficiency-Non-Preempted	3,687	0	4.0	0.00	0.86	0.15	\$1,519	2.58	2.31
	Efficiency-Equipment	3,737	0	4.0	0.00	0.87	0.14	\$2,108	1.85	1.70
	Efficiency & PV	798	0	18.0	1.72	0.46	0.55	\$8,307	2.31	1.76
	Efficiency & PV/Battery	(8)	0	28.5	2.29	0.24	0.78	\$14,047	1.59	1.63
Mixed Fuel to All-Electric <sup>3</sup>	Code Compliant	4,452	0	0.0	0.00	1.01	0.78	(\$5,349)	0.48	1.32
	Efficiency & PV	798	0	18.0	1.72	0.46	1.33	\$2,959	2.75	>1
	Neutral Cost	2,172	0	11.0	1.35	0.70	1.10	\$0	>1	40.07

<sup>1</sup>All reductions and incremental costs relative to the **mixed fuel** code compliant home.

<sup>2</sup>All reductions and incremental costs relative to the **all-electric** code compliant home.

<sup>3</sup>All reductions and incremental costs relative to the **mixed fuel** code compliant home except the EDR Margins are relative to the Standard Design for each case which is the **all-electric** code compliant home. Incremental costs for these packages reflect the costs used in the On-Bill cost effectiveness methodology. Costs differ for the TDV methodology due to differences in the site gas infrastructure costs (see Section 2.6).

<sup>4</sup>This represents the Efficiency EDR Margin for the Efficiency-Non-Preempted and Efficiency-Equipment packages and Total EDR Margin for the Efficiency & PV, Efficiency & PV/Battery, and Neutral Cost packages.

<sup>5</sup>Positive values indicate an increase in PV capacity relative to the Standard Design.



Table 58: Multifamily Climate Zone 5 PG&E/SoCalGas Results Summary (Per Dwelling Unit)

Climate Zone 5 PG&E/SoCalGas Multifamily		Annual Net kWh	Annual therms	EDR Margin <sup>4</sup>	PV Size Change (kW) <sup>5</sup>	CO2-Equivalent Emissions (lbs/sf)		NPV of Lifetime Incremental Cost (\$)	Benefit to Cost Ratio (B/C)	
						Total	Reduction		On-Bill	TDV
Mixed Fuel <sup>1</sup>	Code Compliant	0	131	n/a	n/a	2.10	n/a	n/a	n/a	n/a
	Efficiency-Non-Preempted	(0)	126	0.5	(0.00)	2.03	0.07	\$180	0.85	1.03
	Efficiency-Equipment	(0)	117	1.5	(0.00)	1.92	0.19	\$358	1.09	1.34
	Efficiency & PV/Battery	(7)	126	9.5	0.05	1.84	0.26	\$2,273	0.14	1.38
All-Electric <sup>2</sup>	Code Compliant	2,044	0	n/a	n/a	1.32	n/a	n/a	n/a	n/a
	Efficiency-Non-Preempted	1,990	0	0.5	0.00	1.30	0.03	\$247	1.09	0.86
	Efficiency-Equipment	1,738	0	3.5	0.00	1.15	0.17	\$795	2.15	2.03
	Efficiency & PV	465	0	17.0	0.91	0.70	0.62	\$3,293	2.53	1.82
	Efficiency & PV/Battery	(6)	0	30.0	1.24	0.34	0.98	\$6,314	1.44	1.69
Mixed Fuel to All-Electric <sup>3</sup>	Code Compliant	2,044	0	0.0	0.00	1.32	0.78	(\$2,337)	0.65	1.28
	Efficiency & PV	58	0	17.0	0.91	0.70	1.40	\$956	4.98	>1
	Neutral Cost	874	0	12.5	0.70	0.87	1.23	\$0	>1	23.44

<sup>1</sup>All reductions and incremental costs relative to the **mixed fuel** code compliant home.

<sup>2</sup>All reductions and incremental costs relative to the **all-electric** code compliant home.

<sup>3</sup>All reductions and incremental costs relative to the **mixed fuel** code compliant home except the EDR Margins are relative to the Standard Design for each case which is the **all-electric** code compliant home. Incremental costs for these packages reflect the costs used in the On-Bill cost effectiveness methodology. Costs differ for the TDV methodology due to differences in the site gas infrastructure costs (see Section 2.6).

<sup>4</sup>This represents the Efficiency EDR Margin for the Efficiency-Non-Preempted and Efficiency-Equipment packages and Total EDR Margin for the Efficiency & PV, Efficiency & PV/Battery, and Neutral Cost packages.

<sup>5</sup>Positive values indicate an increase in PV capacity relative to the Standard Design.



**Climate Zone 6**

**Table 59: Single Family Climate Zone 6 Results Summary**

Climate Zone 6 SCE/SoCalGas Single Family		Annual Net kWh	Annual therms	EDR Margin <sup>4</sup>	PV Size Change (kW) <sup>5</sup>	CO2-Equivalent Emissions (lbs/sf)		NPV of Lifetime Incremental Cost (\$)	Benefit to Cost Ratio (B/C)	
						Total	Reduction		On-Bill	TDV
Mixed Fuel <sup>1</sup>	Code Compliant	(0)	249	n/a	n/a	1.57	n/a	n/a	n/a	n/a
	Efficiency-Non-Preempted	0	229	2.0	(0.02)	1.47	0.10	\$1,003	0.66	1.15
	Efficiency-Equipment	(0)	218	1.5	(0.01)	1.41	0.15	\$581	1.58	2.04
	Efficiency & PV/Battery	(13)	229	9.5	0.08	1.22	0.34	\$4,889	0.84	1.27
All-Electric <sup>2</sup>	Code Compliant	3,099	0	n/a	n/a	0.87	n/a	n/a	n/a	n/a
	Efficiency-Non-Preempted	2,885	0	2.0	0.00	0.83	0.05	\$926	1.31	1.41
	Efficiency-Equipment	2,746	0	2.5	0.00	0.80	0.08	\$846	2.20	2.29
	Efficiency & PV	722	0	14.0	1.37	0.63	0.24	\$6,341	1.19	1.48
	Efficiency & PV/Battery	(6)	0	26.0	1.93	0.33	0.55	\$12,036	1.15	1.43
Mixed Fuel to All-Electric <sup>3</sup>	Code Compliant	3,099	0	0.0	0.00	0.87	0.69	(\$5,349)	1.19	2.46
	Efficiency & PV	722	0	14.0	1.37	0.63	0.93	\$992	3.07	>1
	Neutral Cost	959	0	12.0	1.36	0.67	0.89	\$0	>1	>1

<sup>1</sup>All reductions and incremental costs relative to the **mixed fuel** code compliant home.

<sup>2</sup>All reductions and incremental costs relative to the **all-electric** code compliant home.

<sup>3</sup>All reductions and incremental costs relative to the **mixed fuel** code compliant home except the EDR Margins are relative to the Standard Design for each case which is the **all-electric** code compliant home. Incremental costs for these packages reflect the costs used in the On-Bill cost effectiveness methodology. Costs differ for the TDV methodology due to differences in the site gas infrastructure costs (see Section 2.6).

<sup>4</sup>This represents the Efficiency EDR Margin for the Efficiency-Non-Preempted and Efficiency-Equipment packages and Total EDR Margin for the Efficiency & PV, Efficiency & PV/Battery, and Neutral Cost packages.

<sup>5</sup>Positive values indicate an increase in PV capacity relative to the Standard Design.



Table 60: Multifamily Climate Zone 6 Results Summary (Per Dwelling Unit)

Climate Zone 6 SCE/SoCalGas Multifamily		Annual Net kWh	Annual therms	EDR Margin <sup>4</sup>	PV Size Change (kW) <sup>5</sup>	CO2-Equivalent Emissions (lbs/sf)		NPV of Lifetime Incremental Cost (\$)	Benefit to Cost Ratio (B/C)	
						Total	Reduction		On-Bill	TDV
Mixed Fuel <sup>1</sup>	Code Compliant	(0)	114	n/a	n/a	2.17	n/a	n/a	n/a	n/a
	Efficiency-Non-Preempted	(0)	112	1.0	(0.01)	2.14	0.03	\$190	0.65	1.49
	Efficiency-Equipment	(0)	103	1.0	(0.00)	2.03	0.15	\$213	1.43	1.74
	Efficiency & PV/Battery	(6)	112	10.5	0.04	1.76	0.41	\$2,294	0.56	1.35
All-Electric <sup>2</sup>	Code Compliant	1,558	0	n/a	n/a	1.28	n/a	n/a	n/a	n/a
	Efficiency-Non-Preempted	1,531	0	1.0	0.00	1.26	0.02	\$231	0.65	1.34
	Efficiency-Equipment	1,430	0	2.0	0.00	1.20	0.08	\$361	1.62	1.91
	Efficiency & PV	427	0	13.5	0.70	0.97	0.31	\$2,580	1.24	1.71
	Efficiency & PV/Battery	(5)	0	27.5	1.02	0.49	0.79	\$5,590	1.22	1.58
Mixed Fuel to All-Electric <sup>3</sup>	Code Compliant	1,558	0	0.0	0.00	1.28	0.90	(\$2,337)	2.59	2.38
	Efficiency & PV	53	0	13.5	0.70	0.97	1.20	\$243	9.50	>1
	Neutral Cost	459	0	12.5	0.70	0.99	1.18	\$0	>1	>1

<sup>1</sup>All reductions and incremental costs relative to the **mixed fuel** code compliant home.

<sup>2</sup>All reductions and incremental costs relative to the **all-electric** code compliant home.

<sup>3</sup>All reductions and incremental costs relative to the **mixed fuel** code compliant home except the EDR Margins are relative to the Standard Design for each case which is the **all-electric** code compliant home. Incremental costs for these packages reflect the costs used in the On-Bill cost effectiveness methodology. Costs differ for the TDV methodology due to differences in the site gas infrastructure costs (see Section 2.6).

<sup>4</sup>This represents the Efficiency EDR Margin for the Efficiency-Non-Preempted and Efficiency-Equipment packages and Total EDR Margin for the Efficiency & PV, Efficiency & PV/Battery, and Neutral Cost packages.

<sup>5</sup>Positive values indicate an increase in PV capacity relative to the Standard Design.



**Climate Zone 7**

**Table 61: Single Family Climate Zone 7 Results Summary**

Climate Zone 7 SDG&E Single Family		Annual Net kWh	Annual therms	EDR Margin <sup>4</sup>	PV Size Change (kW) <sup>5</sup>	CO2-Equivalent Emissions (lbs/sf)		NPV of Lifetime Incremental Cost (\$)	Benefit to Cost Ratio (B/C)	
						Total	Reduction		On-Bill	TDV
Mixed Fuel <sup>1</sup>	Code Compliant	(0)	196	n/a	n/a	1.30	n/a	n/a	n/a	n/a
	Efficiency-Non-Preempted	(0)	196	0.0	0.00	1.30	0.00	\$0	-	-
	Efficiency-Equipment	0	171	1.5	(0.00)	1.18	0.12	\$606	1.50	1.40
	Efficiency & PV/Battery	(12)	189	9.0	0.10	1.04	0.26	\$4,028	0.06	1.32
All-Electric <sup>2</sup>	Code Compliant	2,479	0	n/a	n/a	0.75	n/a	n/a	n/a	n/a
	Efficiency-Non-Preempted	2,479	0	0.0	0.00	0.75	0.00	\$0	-	-
	Efficiency-Equipment	2,222	0	2.0	0.00	0.69	0.06	\$846	1.60	1.65
	Efficiency & PV	674	0	11.0	1.10	0.58	0.17	\$4,436	1.87	1.55
	Efficiency & PV/Battery	(6)	0	24.0	1.61	0.29	0.46	\$9,936	1.25	1.47
Mixed Fuel to All-Electric <sup>3</sup>	Code Compliant	2,479	0	0.0	0.00	0.75	0.55	(\$5,349)	1.04	2.54
	Efficiency & PV	674	0	11.0	1.10	0.58	0.72	(\$912)	>1	>1
	Neutral Cost	267	0	13.5	1.35	0.55	0.75	\$0	>1	>1

<sup>1</sup>All reductions and incremental costs relative to the **mixed fuel** code compliant home.

<sup>2</sup>All reductions and incremental costs relative to the **all-electric** code compliant home.

<sup>3</sup>All reductions and incremental costs relative to the **mixed fuel** code compliant home except the EDR Margins are relative to the Standard Design for each case which is the **all-electric** code compliant home. Incremental costs for these packages reflect the costs used in the On-Bill cost effectiveness methodology. Costs differ for the TDV methodology due to differences in the site gas infrastructure costs (see Section 2.6).

<sup>4</sup>This represents the Efficiency EDR Margin for the Efficiency-Non-Preempted and Efficiency-Equipment packages and Total EDR Margin for the Efficiency & PV, Efficiency & PV/Battery, and Neutral Cost packages.

<sup>5</sup>Positive values indicate an increase in PV capacity relative to the Standard Design.



Table 62: Multifamily Climate Zone 7 Results Summary (Per Dwelling Unit)

Climate Zone 7 SDG&E Multifamily		Annual Net kWh	Annual therms	EDR Margin <sup>4</sup>	PV Size Change (kW) <sup>5</sup>	CO2-Equivalent Emissions (lbs/sf)		NPV of Lifetime Incremental Cost (\$)	Benefit to Cost Ratio (B/C)	
						Total	Reduction		On-Bill	TDV
Mixed Fuel <sup>1</sup>	Code Compliant	(0)	110	n/a	n/a	2.11	n/a	n/a	n/a	n/a
	Efficiency-Non-Preempted	(0)	108	0.5	(0.01)	2.08	0.03	\$90	0.73	2.24
	Efficiency-Equipment	(0)	99	2.0	(0.00)	1.96	0.15	\$366	1.07	1.41
	Efficiency & PV/Battery	(6)	108	11.0	0.05	1.71	0.40	\$2,188	0.03	1.40
All-Electric <sup>2</sup>	Code Compliant	1,434	0	n/a	n/a	1.21	n/a	n/a	n/a	n/a
	Efficiency-Non-Preempted	1,416	0	0.5	0.00	1.20	0.01	\$202	0.60	1.02
	Efficiency-Equipment	1,319	0	1.5	0.00	1.14	0.07	\$361	1.59	1.71
	Efficiency & PV	412	0	12.5	0.61	0.94	0.27	\$2,261	2.08	1.76
	Efficiency & PV/Battery	(5)	0	27.0	0.92	0.47	0.74	\$5,203	1.19	1.62
Mixed Fuel to All-Electric <sup>3</sup>	Code Compliant	1,434	0	0.0	0.00	1.21	0.90	(\$2,337)	1.12	2.47
	Efficiency & PV	51	0	12.5	0.61	0.94	1.17	(\$75)	>1	>1
	Neutral Cost	294	0	13.5	0.70	0.91	1.20	\$0	>1	>1

<sup>1</sup>All reductions and incremental costs relative to the **mixed fuel** code compliant home.

<sup>2</sup>All reductions and incremental costs relative to the **all-electric** code compliant home.

<sup>3</sup>All reductions and incremental costs relative to the **mixed fuel** code compliant home except the EDR Margins are relative to the Standard Design for each case which is the **all-electric** code compliant home. Incremental costs for these packages reflect the costs used in the On-Bill cost effectiveness methodology. Costs differ for the TDV methodology due to differences in the site gas infrastructure costs (see Section 2.6).

<sup>4</sup>This represents the Efficiency EDR Margin for the Efficiency-Non-Preempted and Efficiency-Equipment packages and Total EDR Margin for the Efficiency & PV, Efficiency & PV/Battery, and Neutral Cost packages.

<sup>5</sup>Positive values indicate an increase in PV capacity relative to the Standard Design.





**Climate Zone 8**

**Table 63: Single Family Climate Zone 8 Results Summary**

Climate Zone 8 SCE/SoCalGas Single Family		Annual Net kWh	Annual therms	EDR Margin <sup>4</sup>	PV Size Change (kW) <sup>5</sup>	CO2-Equivalent Emissions (lbs/sf)		NPV of Lifetime Incremental Cost (\$)	Benefit to Cost Ratio (B/C)	
						Total	Reduction		On-Bill	TDV
Mixed Fuel <sup>1</sup>	Code Compliant	(0)	206	n/a	n/a	1.38	n/a	n/a	n/a	n/a
	Efficiency-Non-Preempted	(0)	198	1.0	(0.02)	1.34	0.05	\$581	0.57	1.41
	Efficiency-Equipment	0	181	1.5	(0.01)	1.27	0.12	\$586	1.30	1.82
	Efficiency & PV/Battery	(13)	198	8.0	0.08	1.11	0.27	\$4,466	0.90	1.31
All-Electric <sup>2</sup>	Code Compliant	2,576	0	n/a	n/a	0.80	n/a	n/a	n/a	n/a
	Efficiency-Non-Preempted	2,483	0	1.5	0.00	0.78	0.02	\$926	0.57	1.22
	Efficiency-Equipment	2,352	0	1.5	0.00	0.75	0.05	\$412	2.82	3.03
	Efficiency & PV	703	0	10.5	1.13	0.62	0.18	\$5,373	1.00	1.48
	Efficiency & PV/Battery	(7)	0	21.5	1.67	0.32	0.48	\$11,016	1.09	1.42
Mixed Fuel to All-Electric <sup>3</sup>	Code Compliant	2,576	0	0.0	0.00	0.80	0.58	(\$5,349)	1.83	2.99
	Efficiency & PV	703	0	10.5	1.13	0.62	0.77	\$25	107.93	>1
	Neutral Cost	439	0	11.0	1.36	0.60	0.78	\$0	>1	>1

<sup>1</sup>All reductions and incremental costs relative to the **mixed fuel** code compliant home.

<sup>2</sup>All reductions and incremental costs relative to the **all-electric** code compliant home.

<sup>3</sup>All reductions and incremental costs relative to the **mixed fuel** code compliant home except the EDR Margins are relative to the Standard Design for each case which is the **all-electric** code compliant home. Incremental costs for these packages reflect the costs used in the On-Bill cost effectiveness methodology. Costs differ for the TDV methodology due to differences in the site gas infrastructure costs (see Section 2.6).

<sup>4</sup>This represents the Efficiency EDR Margin for the Efficiency-Non-Preempted and Efficiency-Equipment packages and Total EDR Margin for the Efficiency & PV, Efficiency & PV/Battery, and Neutral Cost packages.

<sup>5</sup>Positive values indicate an increase in PV capacity relative to the Standard Design.



Table 64: Multifamily Climate Zone 8 Results Summary (Per Dwelling Unit)

Climate Zone 8 SCE/SoCalGas Multifamily		Annual Net kWh	Annual therms	EDR Margin <sup>4</sup>	PV Size Change (kW) <sup>5</sup>	CO2-Equivalent Emissions (lbs/sf)		NPV of Lifetime Incremental Cost (\$)	Benefit to Cost Ratio (B/C)	
						Total	Reduction		On-Bill	TDV
Mixed Fuel <sup>1</sup>	Code Compliant	(0)	109	n/a	n/a	2.18	n/a	n/a	n/a	n/a
	Efficiency-Non-Preempted	(0)	106	1.5	(0.02)	2.13	0.05	\$250	0.70	1.36
	Efficiency-Equipment	(0)	99	1.0	(0.00)	2.04	0.14	\$213	1.37	1.67
	Efficiency & PV/Battery	(6)	106	9.5	0.03	1.77	0.41	\$2,353	0.74	1.32
All-Electric <sup>2</sup>	Code Compliant	1,409	0	n/a	n/a	1.26	n/a	n/a	n/a	n/a
	Efficiency-Non-Preempted	1,373	0	1.0	0.00	1.24	0.02	\$231	0.87	1.72
	Efficiency-Equipment	1,276	0	1.5	0.00	1.18	0.08	\$361	1.63	1.75
	Efficiency & PV	426	0	11.5	0.60	0.99	0.27	\$2,240	1.26	1.78
	Efficiency & PV/Battery	(5)	0	24.0	0.92	0.53	0.73	\$5,249	1.24	1.59
Mixed Fuel to All-Electric <sup>3</sup>	Code Compliant	1,409	0	0.0	0.00	1.26	0.91	(\$2,337)	6.69	2.67
	Efficiency & PV	53	0	11.5	0.60	0.99	1.18	(\$96)	>1	>1
	Neutral Cost	309	0	12.0	0.70	0.98	1.20	\$0	>1	>1

<sup>1</sup>All reductions and incremental costs relative to the **mixed fuel** code compliant home.

<sup>2</sup>All reductions and incremental costs relative to the **all-electric** code compliant home.

<sup>3</sup>All reductions and incremental costs relative to the **mixed fuel** code compliant home except the EDR Margins are relative to the Standard Design for each case which is the **all-electric** code compliant home. Incremental costs for these packages reflect the costs used in the On-Bill cost effectiveness methodology. Costs differ for the TDV methodology due to differences in the site gas infrastructure costs (see Section 2.6).

<sup>4</sup>This represents the Efficiency EDR Margin for the Efficiency-Non-Preempted and Efficiency-Equipment packages and Total EDR Margin for the Efficiency & PV, Efficiency & PV/Battery, and Neutral Cost packages.

<sup>5</sup>Positive values indicate an increase in PV capacity relative to the Standard Design.



**Climate Zone 9**

**Table 65: Single Family Climate Zone 9 Results Summary**

Climate Zone 9 SCE/SoCalGas Single Family		Annual Net kWh	Annual therms	EDR Margin <sup>4</sup>	PV Size Change (kW) <sup>5</sup>	CO2-Equivalent Emissions (lbs/sf)		NPV of Lifetime Incremental Cost (\$)	Benefit to Cost Ratio (B/C)	
						Total	Reduction		On-Bill	TDV
Mixed Fuel <sup>1</sup>	Code Compliant	0	229	n/a	n/a	1.53	n/a	n/a	n/a	n/a
	Efficiency-Non-Preempted	(0)	216	2.5	(0.04)	1.46	0.07	\$912	0.69	1.97
	Efficiency-Equipment	0	201	2.5	(0.04)	1.38	0.15	\$574	1.80	3.66
	Efficiency & PV/Battery	(14)	216	8.5	0.05	1.23	0.30	\$4,785	0.99	1.48
All-Electric <sup>2</sup>	Code Compliant	2,801	0	n/a	n/a	0.87	n/a	n/a	n/a	n/a
	Efficiency-Non-Preempted	2,645	0	2.5	0.00	0.84	0.04	\$1,180	0.78	1.96
	Efficiency-Equipment	2,460	0	3.0	0.00	0.80	0.07	\$846	2.11	3.22
	Efficiency & PV	745	0	11.5	1.16	0.66	0.21	\$5,778	1.08	1.64
	Efficiency & PV/Battery	(9)	0	21.0	1.72	0.37	0.50	\$11,454	1.11	1.53
Mixed Fuel to All-Electric <sup>3</sup>	Code Compliant	2,801	0	0.0	0.00	0.87	0.66	(\$5,349)	1.67	2.90
	Efficiency & PV	745	0	11.5	1.16	0.66	0.87	\$429	7.15	>1
	Neutral Cost	594	0	10.0	1.36	0.67	0.86	\$0	>1	>1

<sup>1</sup>All reductions and incremental costs relative to the **mixed fuel** code compliant home.

<sup>2</sup>All reductions and incremental costs relative to the **all-electric** code compliant home.

<sup>3</sup>All reductions and incremental costs relative to the **mixed fuel** code compliant home except the EDR Margins are relative to the Standard Design for each case which is the **all-electric** code compliant home. Incremental costs for these packages reflect the costs used in the On-Bill cost effectiveness methodology. Costs differ for the TDV methodology due to differences in the site gas infrastructure costs (see Section 2.6).

<sup>4</sup>This represents the Efficiency EDR Margin for the Efficiency-Non-Preempted and Efficiency-Equipment packages and Total EDR Margin for the Efficiency & PV, Efficiency & PV/Battery, and Neutral Cost packages.

<sup>5</sup>Positive values indicate an increase in PV capacity relative to the Standard Design.



Table 66: Multifamily Climate Zone 9 Results Summary (Per Dwelling Unit)

Climate Zone 9 SCE/SoCalGas Multifamily		Annual Net kWh	Annual therms	EDR Margin <sup>4</sup>	PV Size Change (kW) <sup>5</sup>	CO2-Equivalent Emissions (lbs/sf)		NPV of Lifetime Incremental Cost (\$)	Benefit to Cost Ratio (B/C)	
						Total	Reduction		On-Bill	TDV
Mixed Fuel <sup>1</sup>	Code Compliant	0	111	n/a	n/a	2.24	n/a	n/a	n/a	n/a
	Efficiency-Non-Preempted	(0)	109	1.5	(0.03)	2.19	0.05	\$136	1.46	3.35
	Efficiency-Equipment	(0)	101	2.5	(0.03)	2.08	0.16	\$274	1.66	2.87
	Efficiency & PV/Battery	(7)	109	9.5	0.03	1.84	0.40	\$2,234	0.90	1.49
All-Electric <sup>2</sup>	Code Compliant	1,468	0	n/a	n/a	1.33	n/a	n/a	n/a	n/a
	Efficiency-Non-Preempted	1,414	0	1.5	0.00	1.30	0.03	\$231	1.29	2.70
	Efficiency-Equipment	1,334	0	1.5	0.00	1.25	0.08	\$361	1.63	1.58
	Efficiency & PV	441	0	11.0	0.60	1.04	0.29	\$2,232	1.34	1.91
	Efficiency & PV/Battery	(7)	0	23.0	0.92	0.58	0.75	\$5,236	1.28	1.67
Mixed Fuel to All-Electric <sup>3</sup>	Code Compliant	1,468	0	0.0	0.00	1.33	0.91	(\$2,337)	4.38	2.55
	Efficiency & PV	55	0	11.0	0.60	1.04	1.20	(\$104)	>1	>1
	Neutral Cost	331	0	11.0	0.70	1.03	1.21	\$0	>1	>1

<sup>1</sup>All reductions and incremental costs relative to the **mixed fuel** code compliant home.

<sup>2</sup>All reductions and incremental costs relative to the **all-electric** code compliant home.

<sup>3</sup>All reductions and incremental costs relative to the **mixed fuel** code compliant home except the EDR Margins are relative to the Standard Design for each case which is the **all-electric** code compliant home. Incremental costs for these packages reflect the costs used in the On-Bill cost effectiveness methodology. Costs differ for the TDV methodology due to differences in the site gas infrastructure costs (see Section 2.6).

<sup>4</sup>This represents the Efficiency EDR Margin for the Efficiency-Non-Preempted and Efficiency-Equipment packages and Total EDR Margin for the Efficiency & PV, Efficiency & PV/Battery, and Neutral Cost packages.

<sup>5</sup>Positive values indicate an increase in PV capacity relative to the Standard Design.



**Climate Zone 10 SCE/SoCalGas**

**Table 67: Single Family Climate Zone 10 SCE/SoCalGas Results Summary**

Climate Zone 10 SCE/SoCalGas Single Family		Annual Net kWh	Annual therms	EDR Margin <sup>4</sup>	PV Size Change (kW) <sup>5</sup>	CO2-Equivalent Emissions (lbs/sf)		NPV of Lifetime Incremental Cost (\$)	Benefit to Cost Ratio (B/C)	
						Total	Reduction		On-Bill	TDV
Mixed Fuel <sup>1</sup>	Code Compliant	(0)	239	n/a	n/a	1.61	n/a	n/a	n/a	n/a
	Efficiency-Non-Preempted	(0)	217	3.0	(0.07)	1.48	0.13	\$1,648	0.63	1.33
	Efficiency-Equipment	(0)	209	3.0	(0.06)	1.45	0.16	\$593	2.05	3.84
	Efficiency & PV/Battery	(12)	217	9.5	0.03	1.25	0.36	\$5,522	1.00	1.48
All-Electric <sup>2</sup>	Code Compliant	2,981	0	n/a	n/a	0.94	n/a	n/a	n/a	n/a
	Efficiency-Non-Preempted	2,673	0	3.0	0.00	0.88	0.07	\$1,773	0.92	1.52
	Efficiency-Equipment	2,563	0	3.0	0.00	0.85	0.10	\$949	2.27	3.19
	Efficiency & PV	762	0	11.0	1.17	0.70	0.24	\$6,405	1.08	1.50
	Efficiency & PV/Battery	(6)	0	21.0	1.74	0.41	0.53	\$12,129	1.11	1.51
Mixed Fuel to All-Electric <sup>3</sup>	Code Compliant	2,981	0	0.0	0.00	0.94	0.67	(\$5,349)	1.45	2.66
	Efficiency & PV	762	0	11.0	1.17	0.70	0.91	\$1,057	3.04	>1
	Neutral Cost	770	0	9.0	1.36	0.74	0.87	\$0	>1	>1

<sup>1</sup>All reductions and incremental costs relative to the **mixed fuel** code compliant home.

<sup>2</sup>All reductions and incremental costs relative to the **all-electric** code compliant home.

<sup>3</sup>All reductions and incremental costs relative to the **mixed fuel** code compliant home except the EDR Margins are relative to the Standard Design for each case which is the **all-electric** code compliant home. Incremental costs for these packages reflect the costs used in the On-Bill cost effectiveness methodology. Costs differ for the TDV methodology due to differences in the site gas infrastructure costs (see Section 2.6).

<sup>4</sup>This represents the Efficiency EDR Margin for the Efficiency-Non-Preempted and Efficiency-Equipment packages and Total EDR Margin for the Efficiency & PV, Efficiency & PV/Battery, and Neutral Cost packages.

<sup>5</sup>Positive values indicate an increase in PV capacity relative to the Standard Design.



**Table 68: Multifamily Climate Zone 10 SCE/SoCalGas Results Summary (Per Dwelling Unit)**

Climate Zone 10 SCE/SoCalGas Multifamily		Annual Net kWh	Annual therms	EDR Margin <sup>4</sup>	PV Size Change (kW) <sup>5</sup>	CO <sub>2</sub> -Equivalent Emissions (lbs/sf)		NPV of Lifetime Incremental Cost (\$)	Benefit to Cost Ratio (B/C)	
						Total	Reduction		On-Bill	TDV
<b>Mixed Fuel<sup>1</sup></b>	Code Compliant	(0)	112	n/a	n/a	2.29	n/a	n/a	n/a	n/a
	Efficiency-Non-Preempted	(0)	108	1.5	(0.02)	2.23	0.06	\$278	0.81	1.69
	Efficiency-Equipment	(0)	102	2.5	(0.04)	2.13	0.16	\$250	1.96	3.27
	Efficiency & PV/Battery	(6)	108	10.0	0.03	1.88	0.41	\$2,376	0.98	1.57
<b>All-Electric<sup>2</sup></b>	Code Compliant	1,507	0	n/a	n/a	1.39	n/a	n/a	n/a	n/a
	Efficiency-Non-Preempted	1,425	0	1.5	0.00	1.34	0.05	\$361	1.16	2.00
	Efficiency-Equipment	1,369	0	1.5	0.00	1.31	0.08	\$361	1.71	1.98
	Efficiency & PV	450	0	10.5	0.60	1.09	0.30	\$2,371	1.31	1.79
	Efficiency & PV/Battery	(4)	0	23.0	0.93	0.63	0.76	\$5,395	1.27	1.69
<b>Mixed Fuel to All-Electric<sup>3</sup></b>	Code Compliant	1,507	0	0.0	0.00	1.39	0.90	(\$2,337)	3.35	2.36
	Efficiency & PV	56	0	10.5	0.60	1.09	1.20	\$34	70.89	>1
	Neutral Cost	372	0	10.5	0.70	1.10	1.19	\$0	>1	>1

<sup>1</sup>All reductions and incremental costs relative to the **mixed fuel** code compliant home.

<sup>2</sup>All reductions and incremental costs relative to the **all-electric** code compliant home.

<sup>3</sup>All reductions and incremental costs relative to the **mixed fuel** code compliant home except the EDR Margins are relative to the Standard Design for each case which is the **all-electric** code compliant home. Incremental costs for these packages reflect the costs used in the On-Bill cost effectiveness methodology. Costs differ for the TDV methodology due to differences in the site gas infrastructure costs (see Section 2.6).

<sup>4</sup>This represents the Efficiency EDR Margin for the Efficiency-Non-Preempted and Efficiency-Equipment packages and Total EDR Margin for the Efficiency & PV, Efficiency & PV/Battery, and Neutral Cost packages.

<sup>5</sup>Positive values indicate an increase in PV capacity relative to the Standard Design.



**Climate Zone 10 SDGE**

**Table 69: Single Family Climate Zone 10 SDGE Results Summary**

Climate Zone 10 SDG&E Single Family		Annual Net kWh	Annual therms	EDR Margin <sup>4</sup>	PV Size Change (kW) <sup>5</sup>	CO2-Equivalent Emissions (lbs/sf)		NPV of Lifetime Incremental Cost (\$)	Benefit to Cost Ratio (B/C)	
						Total	Reduction		On-Bill	TDV
Mixed Fuel <sup>1</sup>	Code Compliant	(0)	239	n/a	n/a	1.61	n/a	n/a	n/a	n/a
	Efficiency-Non-Preempted	(0)	217	3.0	(0.07)	1.48	0.13	\$1,648	0.80	1.33
	Efficiency-Equipment	(0)	209	3.0	(0.06)	1.45	0.16	\$593	2.64	3.84
	Efficiency & PV/Battery	(12)	217	9.5	0.03	1.25	0.36	\$5,522	0.58	1.48
All-Electric <sup>2</sup>	Code Compliant	2,981	0	n/a	n/a	0.94	n/a	n/a	n/a	n/a
	Efficiency-Non-Preempted	2,673	0	3.0	0.00	0.88	0.07	\$1,773	1.08	1.52
	Efficiency-Equipment	2,563	0	3.0	0.00	0.85	0.10	\$949	2.62	3.19
	Efficiency & PV	762	0	11.0	1.17	0.70	0.24	\$6,405	1.68	1.50
	Efficiency & PV/Battery	(6)	0	21.0	1.74	0.41	0.53	\$12,129	1.42	1.51
Mixed Fuel to All-Electric <sup>3</sup>	Code Compliant	2,981	0	0.0	0.00	0.94	0.67	(\$5,349)	0.90	2.66
	Efficiency & PV	762	0	11.0	1.17	0.70	0.91	\$1,057	4.55	>1
	Neutral Cost	770	0	9.0	1.36	0.74	0.87	\$0	>1	>1

<sup>1</sup>All reductions and incremental costs relative to the **mixed fuel** code compliant home.

<sup>2</sup>All reductions and incremental costs relative to the **all-electric** code compliant home.

<sup>3</sup>All reductions and incremental costs relative to the **mixed fuel** code compliant home except the EDR Margins are relative to the Standard Design for each case which is the **all-electric** code compliant home. Incremental costs for these packages reflect the costs used in the On-Bill cost effectiveness methodology. Costs differ for the TDV methodology due to differences in the site gas infrastructure costs (see Section 2.6).

<sup>4</sup>This represents the Efficiency EDR Margin for the Efficiency-Non-Preempted and Efficiency-Equipment packages and Total EDR Margin for the Efficiency & PV, Efficiency & PV/Battery, and Neutral Cost packages.

<sup>5</sup>Positive values indicate an increase in PV capacity relative to the Standard Design.



**Table 70: Multifamily Climate Zone 10 SDGE Results Summary (Per Dwelling Unit)**

Climate Zone 10 SDG&E Multifamily		Annual Net kWh	Annual therms	EDR Margin <sup>4</sup>	PV Size Change (kW) <sup>5</sup>	CO <sub>2</sub> -Equivalent Emissions (lbs/sf)		NPV of Lifetime Incremental Cost (\$)	Benefit to Cost Ratio (B/C)	
						Total	Reduction		On-Bill	TDV
Mixed Fuel <sup>1</sup>	Code Compliant	(0)	112	n/a	n/a	2.29	n/a	n/a	n/a	n/a
	Efficiency-Non-Preempted	(0)	108	1.5	(0.02)	2.23	0.06	\$278	1.09	1.69
	Efficiency-Equipment	(0)	102	2.5	(0.04)	2.13	0.16	\$250	2.60	3.27
	Efficiency & PV/Battery	(6)	108	10.0	0.03	1.88	0.41	\$2,376	0.23	1.57
All-Electric <sup>2</sup>	Code Compliant	1,507	0	n/a	n/a	1.39	n/a	n/a	n/a	n/a
	Efficiency-Non-Preempted	1,425	0	1.5	0.00	1.34	0.05	\$361	1.53	2.00
	Efficiency-Equipment	1,369	0	1.5	0.00	1.31	0.08	\$361	2.05	1.98
	Efficiency & PV	450	0	10.5	0.60	1.09	0.30	\$2,371	2.12	1.79
	Efficiency & PV/Battery	(4)	0	23.0	0.93	0.63	0.76	\$5,395	1.44	1.69
Mixed Fuel to All-Electric <sup>3</sup>	Code Compliant	1,507	0	0.0	0.00	1.39	0.90	(\$2,337)	0.73	2.36
	Efficiency & PV	56	0	10.5	0.60	1.09	1.20	\$34	54.15	>1
	Neutral Cost	372	0	10.5	0.70	1.10	1.19	\$0	>1	>1

<sup>1</sup>All reductions and incremental costs relative to the **mixed fuel** code compliant home.

<sup>2</sup>All reductions and incremental costs relative to the **all-electric** code compliant home.

<sup>3</sup>All reductions and incremental costs relative to the **mixed fuel** code compliant home except the EDR Margins are relative to the Standard Design for each case which is the **all-electric** code compliant home. Incremental costs for these packages reflect the costs used in the On-Bill cost effectiveness methodology. Costs differ for the TDV methodology due to differences in the site gas infrastructure costs (see Section 2.6).

<sup>4</sup>This represents the Efficiency EDR Margin for the Efficiency-Non-Preempted and Efficiency-Equipment packages and Total EDR Margin for the Efficiency & PV, Efficiency & PV/Battery, and Neutral Cost packages.

<sup>5</sup>Positive values indicate an increase in PV capacity relative to the Standard Design.





**Climate Zone 11**

**Table 71: Single Family Climate Zone 11 Results Summary**

Climate Zone 11 PG&E Single Family		Annual Net kWh	Annual therms	EDR Margin <sup>4</sup>	PV Size Change (kW) <sup>5</sup>	CO2-Equivalent Emissions (lbs/sf)		NPV of Lifetime Incremental Cost (\$)	Benefit to Cost Ratio (B/C)	
						Total	Reduction		On-Bill	TDV
Mixed Fuel <sup>1</sup>	Code Compliant	(0)	378	n/a	n/a	2.14	n/a	n/a	n/a	n/a
	Efficiency-Non-Preempted	(0)	333	4.0	(0.19)	1.90	0.24	\$3,143	0.78	1.20
	Efficiency-Equipment	0	320	5.0	(0.21)	1.83	0.31	\$1,222	2.50	3.68
	Efficiency & PV/Battery	(18)	333	9.0	(0.09)	1.78	0.36	\$7,026	0.36	1.51
All-Electric <sup>2</sup>	Code Compliant	4,585	0	n/a	n/a	1.15	n/a	n/a	n/a	n/a
	Efficiency-Non-Preempted	3,815	0	4.5	0.00	0.99	0.16	\$3,735	1.24	1.47
	Efficiency-Equipment	3,533	0	5.5	0.00	0.93	0.22	\$2,108	2.97	3.33
	Efficiency & PV	957	0	14.0	1.79	0.60	0.55	\$10,827	1.84	1.55
	Efficiency & PV/Battery	(13)	0	23.0	2.49	0.36	0.79	\$17,077	1.49	1.61
Mixed Fuel to All-Electric <sup>3</sup>	Code Compliant	4,585	0	0.0	0.00	1.15	0.99	(\$5,349)	0.49	1.69
	Efficiency & PV	957	0	14.0	1.79	0.60	1.54	\$5,478	1.64	>1
	Neutral Cost	2,429	0	7.0	1.36	0.85	1.29	\$0	>1	>1

<sup>1</sup>All reductions and incremental costs relative to the **mixed fuel** code compliant home.

<sup>2</sup>All reductions and incremental costs relative to the **all-electric** code compliant home.

<sup>3</sup>All reductions and incremental costs relative to the **mixed fuel** code compliant home except the EDR Margins are relative to the Standard Design for each case which is the **all-electric** code compliant home. Incremental costs for these packages reflect the costs used in the On-Bill cost effectiveness methodology. Costs differ for the TDV methodology due to differences in the site gas infrastructure costs (see Section 2.6).

<sup>4</sup>This represents the Efficiency EDR Margin for the Efficiency-Non-Preempted and Efficiency-Equipment packages and Total EDR Margin for the Efficiency & PV, Efficiency & PV/Battery, and Neutral Cost packages.

<sup>5</sup>Positive values indicate an increase in PV capacity relative to the Standard Design.



Table 72: Multifamily Climate Zone 11 Results Summary (Per Dwelling Unit)

Climate Zone 11 PG&E Multifamily		Annual Net kWh	Annual therms	EDR Margin <sup>4</sup>	PV Size Change (kW) <sup>5</sup>	CO2-Equivalent Emissions (lbs/sf)		NPV of Lifetime Incremental Cost (\$)	Benefit to Cost Ratio (B/C)	
						Total	Reduction		On-Bill	TDV
Mixed Fuel <sup>1</sup>	Code Compliant	(0)	141	n/a	n/a	2.38	n/a	n/a	n/a	n/a
	Efficiency-Non-Preempted	0	127	2.5	(0.05)	2.18	0.20	\$850	0.65	1.17
	Efficiency-Equipment	(0)	126	3.0	(0.06)	2.16	0.22	\$317	1.84	3.29
	Efficiency & PV/Battery	(9)	127	10.5	0.01	2.00	0.38	\$2,950	0.39	1.60
All-Electric <sup>2</sup>	Code Compliant	1,974	0	n/a	n/a	1.42	n/a	n/a	n/a	n/a
	Efficiency-Non-Preempted	1,732	0	3.5	0.00	1.29	0.13	\$1,011	1.40	1.64
	Efficiency-Equipment	1,707	0	3.5	0.00	1.26	0.16	\$795	2.02	2.33
	Efficiency & PV	504	0	13.0	0.77	0.81	0.61	\$3,601	2.22	1.81
	Efficiency & PV/Battery	(6)	0	25.0	1.14	0.45	0.98	\$6,759	1.42	1.81
Mixed Fuel to All-Electric <sup>3</sup>	Code Compliant	1,974	0	0.0	0.00	1.42	0.96	(\$2,337)	0.56	1.33
	Efficiency & PV	63	0	13.0	0.77	0.81	1.56	\$1,264	3.03	>1
	Neutral Cost	866	0	9.0	0.70	0.99	1.38	\$0	>1	73.96

<sup>1</sup>All reductions and incremental costs relative to the **mixed fuel** code compliant home.

<sup>2</sup>All reductions and incremental costs relative to the **all-electric** code compliant home.

<sup>3</sup>All reductions and incremental costs relative to the **mixed fuel** code compliant home except the EDR Margins are relative to the Standard Design for each case which is the **all-electric** code compliant home. Incremental costs for these packages reflect the costs used in the On-Bill cost effectiveness methodology. Costs differ for the TDV methodology due to differences in the site gas infrastructure costs (see Section 2.6).

<sup>4</sup>This represents the Efficiency EDR Margin for the Efficiency-Non-Preempted and Efficiency-Equipment packages and Total EDR Margin for the Efficiency & PV, Efficiency & PV/Battery, and Neutral Cost packages.

<sup>5</sup>Positive values indicate an increase in PV capacity relative to the Standard Design.



**Climate Zone 12**

**Table 73: Single Family Climate Zone 12 Results Summary**

Climate Zone 12 PG&E Single Family		Annual Net kWh	Annual therms	EDR Margin <sup>4</sup>	PV Size Change (kW) <sup>5</sup>	CO2-Equivalent Emissions (lbs/sf)		NPV of Lifetime Incremental Cost (\$)	Benefit to Cost Ratio (B/C)	
						Total	Reduction		On-Bill	TDV
Mixed Fuel <sup>1</sup>	Code Compliant	(0)	390	n/a	n/a	2.11	n/a	n/a	n/a	n/a
	Efficiency-Non-Preempted	(0)	344	3.5	(0.06)	1.88	0.23	\$1,679	1.18	1.83
	Efficiency-Equipment	0	338	3.0	(0.05)	1.85	0.26	\$654	3.31	4.65
	Efficiency & PV/Battery	(23)	344	9.5	0.04	1.76	0.35	\$5,568	0.43	1.72
All-Electric <sup>2</sup>	Code Compliant	4,492	0	n/a	n/a	1.05	n/a	n/a	n/a	n/a
	Efficiency-Non-Preempted	3,958	0	3.5	0.00	0.94	0.10	\$3,735	0.78	1.06
	Efficiency-Equipment	3,721	0	5.0	0.00	0.90	0.15	\$2,108	2.00	2.51
	Efficiency & PV	867	0	15.5	1.97	0.51	0.53	\$11,520	1.69	1.41
	Efficiency & PV/Battery	(15)	0	25.0	2.62	0.29	0.76	\$17,586	1.29	1.48
Mixed Fuel to All-Electric <sup>3</sup>	Code Compliant	4,492	0	0.0	0.00	1.05	1.07	(\$5,349)	0.63	1.89
	Efficiency & PV	867	0	15.5	1.97	0.51	1.60	\$6,172	1.77	>1
	Neutral Cost	2,374	0	8.0	1.35	0.76	1.36	\$0	>1	>1

<sup>1</sup>All reductions and incremental costs relative to the **mixed fuel** code compliant home.

<sup>2</sup>All reductions and incremental costs relative to the **all-electric** code compliant home.

<sup>3</sup>All reductions and incremental costs relative to the **mixed fuel** code compliant home except the EDR Margins are relative to the Standard Design for each case which is the **all-electric** code compliant home. Incremental costs for these packages reflect the costs used in the On-Bill cost effectiveness methodology. Costs differ for the TDV methodology due to differences in the site gas infrastructure costs (see Section 2.6).

<sup>4</sup>This represents the Efficiency EDR Margin for the Efficiency-Non-Preempted and Efficiency-Equipment packages and Total EDR Margin for the Efficiency & PV, Efficiency & PV/Battery, and Neutral Cost packages.

<sup>5</sup>Positive values indicate an increase in PV capacity relative to the Standard Design.



Table 74: Multifamily Climate Zone 12 Results Summary (Per Dwelling Unit)

Climate Zone 12 PG&E Multifamily		Annual Net kWh	Annual therms	EDR Margin <sup>4</sup>	PV Size Change (kW) <sup>5</sup>	CO2-Equivalent Emissions (lbs/sf)		NPV of Lifetime Incremental Cost (\$)	Benefit to Cost Ratio (B/C)	
						Total	Reduction		On-Bill	TDV
Mixed Fuel <sup>1</sup>	Code Compliant	(0)	143	n/a	n/a	2.33	n/a	n/a	n/a	n/a
	Efficiency-Non-Preempted	(0)	135	1.5	(0.02)	2.21	0.12	\$291	1.10	2.22
	Efficiency-Equipment	0	128	2.5	(0.03)	2.12	0.21	\$434	1.25	2.22
	Efficiency & PV/Battery	(11)	135	10.0	0.03	2.03	0.30	\$2,394	0.30	1.75
All-Electric <sup>2</sup>	Code Compliant	1,963	0	n/a	n/a	1.34	n/a	n/a	n/a	n/a
	Efficiency-Non-Preempted	1,792	0	2.5	0.00	1.24	0.09	\$1,011	0.91	1.12
	Efficiency-Equipment	1,744	0	2.5	0.00	1.21	0.13	\$795	1.56	1.63
	Efficiency & PV	472	0	14.0	0.84	0.73	0.60	\$3,835	2.08	1.65
	Efficiency & PV/Battery	(8)	0	26.5	1.20	0.38	0.96	\$6,943	1.26	1.68
Mixed Fuel to All-Electric <sup>3</sup>	Code Compliant	1,963	0	0.0	0.00	1.34	1.00	(\$2,337)	0.64	1.66
	Efficiency & PV	59	0	14.0	0.84	0.73	1.60	\$1,498	2.88	>1
	Neutral Cost	872	0	9.5	0.70	0.92	1.42	\$0	>1	>1

<sup>1</sup>All reductions and incremental costs relative to the **mixed fuel** code compliant home.

<sup>2</sup>All reductions and incremental costs relative to the **all-electric** code compliant home.

<sup>3</sup>All reductions and incremental costs relative to the **mixed fuel** code compliant home except the EDR Margins are relative to the Standard Design for each case which is the **all-electric** code compliant home. Incremental costs for these packages reflect the costs used in the On-Bill cost effectiveness methodology. Costs differ for the TDV methodology due to differences in the site gas infrastructure costs (see Section 2.6).

<sup>4</sup>This represents the Efficiency EDR Margin for the Efficiency-Non-Preempted and Efficiency-Equipment packages and Total EDR Margin for the Efficiency & PV, Efficiency & PV/Battery, and Neutral Cost packages.

<sup>5</sup>Positive values indicate an increase in PV capacity relative to the Standard Design.



**Climate Zone 13**

**Table 75: Single Family Climate Zone 13 Results Summary**

Climate Zone 13 PG&E Single Family		Annual Net kWh	Annual therms	EDR Margin <sup>4</sup>	PV Size Change (kW) <sup>5</sup>	CO2-Equivalent Emissions (lbs/sf)		NPV of Lifetime Incremental Cost (\$)	Benefit to Cost Ratio (B/C)	
						Total	Reduction		On-Bill	TDV
Mixed Fuel <sup>1</sup>	Code Compliant	(0)	352	n/a	n/a	2.02	n/a	n/a	n/a	n/a
	Efficiency-Non-Preempted	(0)	311	4.5	(0.21)	1.80	0.22	\$3,060	0.76	1.28
	Efficiency-Equipment	(0)	292	5.5	(0.24)	1.70	0.32	\$611	5.26	8.40
	Efficiency & PV/Battery	(19)	311	9.5	(0.11)	1.69	0.33	\$6,954	0.36	1.56
All-Electric <sup>2</sup>	Code Compliant	4,180	0	n/a	n/a	1.08	n/a	n/a	n/a	n/a
	Efficiency-Non-Preempted	3,428	0	5.0	0.00	0.92	0.15	\$4,154	1.12	1.40
	Efficiency-Equipment	3,177	0	6.0	0.00	0.87	0.21	\$2,108	2.88	3.30
	Efficiency & PV	934	0	13.0	1.61	0.57	0.50	\$10,532	1.70	1.47
	Efficiency & PV/Battery	(11)	0	22.0	2.32	0.35	0.73	\$16,806	1.40	1.54
Mixed Fuel to All-Electric <sup>3</sup>	Code Compliant	4,180	0	0.0	0.00	1.08	0.94	(\$5,349)	0.54	1.83
	Efficiency & PV	934	0	13.0	1.61	0.57	1.44	\$5,184	1.56	>1
	Neutral Cost	2,092	0	7.0	1.36	0.79	1.23	\$0	>1	>1

<sup>1</sup>All reductions and incremental costs relative to the **mixed fuel** code compliant home.

<sup>2</sup>All reductions and incremental costs relative to the **all-electric** code compliant home.

<sup>3</sup>All reductions and incremental costs relative to the **mixed fuel** code compliant home except the EDR Margins are relative to the Standard Design for each case which is the **all-electric** code compliant home. Incremental costs for these packages reflect the costs used in the On-Bill cost effectiveness methodology. Costs differ for the TDV methodology due to differences in the site gas infrastructure costs (see Section 2.6).

<sup>4</sup>This represents the Efficiency EDR Margin for the Efficiency-Non-Preempted and Efficiency-Equipment packages and Total EDR Margin for the Efficiency & PV, Efficiency & PV/Battery, and Neutral Cost packages.

<sup>5</sup>Positive values indicate an increase in PV capacity relative to the Standard Design.



Table 76: Multifamily Climate Zone 13 Results Summary (Per Dwelling Unit)

Climate Zone 13 PG&E Multifamily		Annual Net kWh	Annual therms	EDR Margin <sup>4</sup>	PV Size Change (kW) <sup>5</sup>	CO2-Equivalent Emissions (lbs/sf)		NPV of Lifetime Incremental Cost (\$)	Benefit to Cost Ratio (B/C)	
						Total	Reduction		On-Bill	TDV
Mixed Fuel <sup>1</sup>	Code Compliant	(0)	135	n/a	n/a	2.30	n/a	n/a	n/a	n/a
	Efficiency-Non-Preempted	(0)	123	3.0	(0.05)	2.12	0.18	\$831	0.63	1.27
	Efficiency-Equipment	(0)	121	3.0	(0.07)	2.10	0.21	\$290	1.95	3.75
	Efficiency & PV/Battery	(9)	123	10.5	0.00	1.95	0.35	\$2,936	0.38	1.64
All-Electric <sup>2</sup>	Code Compliant	1,849	0	n/a	n/a	1.36	n/a	n/a	n/a	n/a
	Efficiency-Non-Preempted	1,629	0	3.0	0.00	1.24	0.12	\$1,011	1.31	1.56
	Efficiency-Equipment	1,590	0	3.5	0.00	1.21	0.16	\$795	1.98	2.28
	Efficiency & PV	501	0	12.0	0.73	0.80	0.56	\$3,462	2.12	1.71
	Efficiency & PV/Battery	(5)	0	23.5	1.11	0.44	0.92	\$6,650	1.35	1.74
Mixed Fuel to All-Electric <sup>3</sup>	Code Compliant	1,849	0	0.0	0.00	1.36	0.94	(\$2,337)	0.63	1.54
	Efficiency & PV	63	0	12.0	0.73	0.80	1.50	\$1,125	3.22	>1
	Neutral Cost	773	0	8.5	0.70	0.94	1.36	\$0	>1	>1

<sup>1</sup>All reductions and incremental costs relative to the **mixed fuel** code compliant home.

<sup>2</sup>All reductions and incremental costs relative to the **all-electric** code compliant home.

<sup>3</sup>All reductions and incremental costs relative to the **mixed fuel** code compliant home except the EDR Margins are relative to the Standard Design for each case which is the **all-electric** code compliant home. Incremental costs for these packages reflect the costs used in the On-Bill cost effectiveness methodology. Costs differ for the TDV methodology due to differences in the site gas infrastructure costs (see Section 2.6).

<sup>4</sup>This represents the Efficiency EDR Margin for the Efficiency-Non-Preempted and Efficiency-Equipment packages and Total EDR Margin for the Efficiency & PV, Efficiency & PV/Battery, and Neutral Cost packages.

<sup>5</sup>Positive values indicate an increase in PV capacity relative to the Standard Design.



**Climate Zone 14 SCE/SoCalGas**

**Table 77: Single Family Climate Zone 14 SCE/SoCalGas Results Summary**

Climate Zone 14 SCE/SoCalGas Single Family		Annual Net kWh	Annual therms	EDR Margin <sup>4</sup>	PV Size Change (kW) <sup>5</sup>	CO2-Equivalent Emissions (lbs/sf)		NPV of Lifetime Incremental Cost (\$)	Benefit to Cost Ratio (B/C)	
						Total	Reduction		On-Bill	TDV
Mixed Fuel <sup>1</sup>	Code Compliant	(0)	371	n/a	n/a	2.35	n/a	n/a	n/a	n/a
	Efficiency-Non-Preempted	(0)	319	4.5	(0.17)	2.06	0.29	\$1,662	1.57	2.46
	Efficiency-Equipment	(0)	305	5.5	(0.19)	1.98	0.36	\$799	3.95	6.14
	Efficiency & PV/Battery	(5)	319	9.0	(0.08)	1.83	0.52	\$5,526	1.31	1.74
All-Electric <sup>2</sup>	Code Compliant	4,725	0	n/a	n/a	1.38	n/a	n/a	n/a	n/a
	Efficiency-Non-Preempted	3,819	0	5.5	0.00	1.19	0.19	\$4,154	0.95	1.46
	Efficiency-Equipment	3,676	0	6.0	0.00	1.16	0.22	\$2,108	2.29	3.13
	Efficiency & PV	953	0	15.5	1.60	0.93	0.45	\$10,459	1.21	1.62
	Efficiency & PV/Battery	(2)	0	23.5	2.21	0.63	0.75	\$16,394	1.35	1.59
Mixed Fuel to All-Electric <sup>3</sup>	Code Compliant	4,725	0	0.0	0.00	1.38	0.97	(\$5,349)	0.72	1.67
	Efficiency & PV	953	0	15.5	1.60	0.93	1.42	\$5,111	1.01	>1
	Neutral Cost	2,299	0	8.5	1.35	1.15	1.19	\$0	0.00	>1
	Min Cost Effectiveness	1,853	0	10.0	1.61	1.12	1.23	(\$1,000)	1.24	>1

<sup>1</sup>All reductions and incremental costs relative to the **mixed fuel** code compliant home.

<sup>2</sup>All reductions and incremental costs relative to the **all-electric** code compliant home.

<sup>3</sup>All reductions and incremental costs relative to the **mixed fuel** code compliant home except the EDR Margins are relative to the Standard Design for each case which is the **all-electric** code compliant home. Incremental costs for these packages reflect the costs used in the On-Bill cost effectiveness methodology. Costs differ for the TDV methodology due to differences in the site gas infrastructure costs (see Section 2.6).

<sup>4</sup>This represents the Efficiency EDR Margin for the Efficiency-Non-Preempted and Efficiency-Equipment packages and Total EDR Margin for the Efficiency & PV, Efficiency & PV/Battery, Neutral Cost, and Min Cost Effectiveness packages.

<sup>5</sup>Positive values indicate an increase in PV capacity relative to the Standard Design.



Table 78: Multifamily Climate Zone 14 SCE/SoCalGas Results Summary (Per Dwelling Unit)

Climate Zone 14 SCE/SoCalGas Multifamily		Annual Net kWh	Annual therms	EDR Margin <sup>4</sup>	PV Size Change (kW) <sup>5</sup>	CO2-Equivalent Emissions (lbs/sf)		NPV of Lifetime Incremental Cost (\$)	Benefit to Cost Ratio (B/C)	
						Total	Reduction		On-Bill	TDV
Mixed Fuel <sup>1</sup>	Code Compliant	(0)	141	n/a	n/a	2.76	n/a	n/a	n/a	n/a
	Efficiency-Non-Preempted	(0)	126	3.0	(0.04)	2.53	0.23	\$874	0.73	1.21
	Efficiency-Equipment	(0)	126	3.0	(0.05)	2.52	0.23	\$347	1.96	2.99
	Efficiency & PV/Battery	(3)	126	9.5	0.01	2.18	0.58	\$2,957	1.09	1.39
All-Electric <sup>2</sup>	Code Compliant	2,022	0	n/a	n/a	1.73	n/a	n/a	n/a	n/a
	Efficiency-Non-Preempted	1,759	0	3.5	0.00	1.58	0.15	\$1,011	1.24	1.65
	Efficiency-Equipment	1,748	0	3.5	0.00	1.56	0.16	\$795	1.59	2.20
	Efficiency & PV	504	0	14.0	0.70	1.26	0.47	\$3,356	1.39	1.91
	Efficiency & PV/Battery	(2)	0	24.5	1.03	0.79	0.94	\$6,380	1.36	1.77
Mixed Fuel to All-Electric <sup>3</sup>	Code Compliant	2,022	0	0.0	0.00	1.73	1.03	(\$2,337)	1.13	1.48
	Efficiency & PV	63	0	14.0	0.70	1.26	1.50	\$1,019	2.57	>1
	Neutral Cost	772	0	10.0	0.70	1.41	1.35	\$0	>1	>1

<sup>1</sup>All reductions and incremental costs relative to the **mixed fuel** code compliant home.

<sup>2</sup>All reductions and incremental costs relative to the **all-electric** code compliant home.

<sup>3</sup>All reductions and incremental costs relative to the **mixed fuel** code compliant home except the EDR Margins are relative to the Standard Design for each case which is the **all-electric** code compliant home. Incremental costs for these packages reflect the costs used in the On-Bill cost effectiveness methodology. Costs differ for the TDV methodology due to differences in the site gas infrastructure costs (see Section 2.6).

<sup>4</sup>This represents the Efficiency EDR Margin for the Efficiency-Non-Preempted and Efficiency-Equipment packages and Total EDR Margin for the Efficiency & PV, Efficiency & PV/Battery, and Neutral Cost packages.

<sup>5</sup>Positive values indicate an increase in PV capacity relative to the Standard Design.





**Climate Zone 14 SDGE**

**Table 79: Single Family Climate Zone 14 SDGE Results Summary**

Climate Zone 14 SDG&E Single Family		Annual Net kWh	Annual therms	EDR Margin <sup>4</sup>	PV Size Change (kW) <sup>5</sup>	CO2-Equivalent Emissions (lbs/sf)		NPV of Lifetime Incremental Cost (\$)	Benefit to Cost Ratio (B/C)	
						Total	Reduction		On-Bill	TDV
Mixed Fuel <sup>1</sup>	Code Compliant	(0)	371	n/a	n/a	2.35	n/a	n/a	n/a	n/a
	Efficiency-Non-Preempted	(0)	319	4.5	(0.17)	2.06	0.29	\$1,662	1.92	2.46
	Efficiency-Equipment	(0)	305	5.5	(0.19)	1.98	0.36	\$799	4.88	6.14
	Efficiency & PV/Battery	(5)	319	9.0	(0.08)	1.83	0.52	\$5,526	1.23	1.74
All-Electric <sup>2</sup>	Code Compliant	4,725	0	n/a	n/a	1.38	n/a	n/a	n/a	n/a
	Efficiency-Non-Preempted	3,819	0	5.5	0.00	1.19	0.19	\$4,154	1.30	1.46
	Efficiency-Equipment	3,676	0	6.0	0.00	1.16	0.22	\$2,108	2.92	3.13
	Efficiency & PV	953	0	15.5	1.60	0.93	0.45	\$10,459	1.80	1.62
	Efficiency & PV/Battery	(2)	0	23.5	2.21	0.63	0.75	\$16,394	1.67	1.59
Mixed Fuel to All-Electric <sup>3</sup>	Code Compliant	4,725	0	0.0	0.00	1.38	0.97	(\$5,349)	0.60	1.67
	Efficiency & PV	953	0	15.5	1.60	0.93	1.42	\$5,111	1.94	>1
	Neutral Cost	2,299	0	8.5	1.35	1.15	1.19	\$0	>1	>1

<sup>1</sup>All reductions and incremental costs relative to the **mixed fuel** code compliant home.

<sup>2</sup>All reductions and incremental costs relative to the **all-electric** code compliant home.

<sup>3</sup>All reductions and incremental costs relative to the **mixed fuel** code compliant home except the EDR Margins are relative to the Standard Design for each case which is the **all-electric** code compliant home. Incremental costs for these packages reflect the costs used in the On-Bill cost effectiveness methodology. Costs differ for the TDV methodology due to differences in the site gas infrastructure costs (see Section 2.6).

<sup>4</sup>This represents the Efficiency EDR Margin for the Efficiency-Non-Preempted and Efficiency-Equipment packages and Total EDR Margin for the Efficiency & PV, Efficiency & PV/Battery, and Neutral Cost packages.

<sup>5</sup>Positive values indicate an increase in PV capacity relative to the Standard Design.



Table 80: Multifamily Climate Zone 14 SDGE Results Summary (Per Dwelling Unit)

Climate Zone 14 SDG&E Multifamily		Annual Net kWh	Annual therms	EDR Margin <sup>4</sup>	PV Size Change (kW) <sup>5</sup>	CO <sub>2</sub> -Equivalent Emissions (lbs/sf)		NPV of Lifetime Incremental Cost (\$)	Benefit to Cost Ratio (B/C)	
						Total	Reduction		On-Bill	TDV
Mixed Fuel <sup>1</sup>	Code Compliant	(0)	141	n/a	n/a	2.76	n/a	n/a	n/a	n/a
	Efficiency-Non-Preempted	(0)	126	3.0	(0.04)	2.53	0.23	\$874	0.93	1.21
	Efficiency-Equipment	(0)	126	3.0	(0.05)	2.52	0.23	\$347	2.48	2.99
	Efficiency & PV/Battery	(3)	126	9.5	0.01	2.18	0.58	\$2,957	0.51	1.39
All-Electric <sup>2</sup>	Code Compliant	2,022	0	n/a	n/a	1.73	n/a	n/a	n/a	n/a
	Efficiency-Non-Preempted	1,759	0	3.5	0.00	1.58	0.15	\$1,011	1.47	1.65
	Efficiency-Equipment	1,748	0	3.5	0.00	1.56	0.16	\$795	2.00	2.20
	Efficiency & PV	504	0	14.0	0.70	1.26	0.47	\$3,356	2.16	1.91
	Efficiency & PV/Battery	(2)	0	24.5	1.03	0.79	0.94	\$6,380	1.69	1.77
Mixed Fuel to All-Electric <sup>3</sup>	Code Compliant	2,022	0	0.0	0.00	1.73	1.03	(\$2,337)	0.51	1.48
	Efficiency & PV	63	0	14.0	0.70	1.26	1.50	\$1,019	2.60	>1
	Neutral Cost	772	0	10.0	0.70	1.41	1.35	\$0	>1	>1

<sup>1</sup>All reductions and incremental costs relative to the **mixed fuel** code compliant home.

<sup>2</sup>All reductions and incremental costs relative to the **all-electric** code compliant home.

<sup>3</sup>All reductions and incremental costs relative to the **mixed fuel** code compliant home except the EDR Margins are relative to the Standard Design for each case which is the **all-electric** code compliant home. Incremental costs for these packages reflect the costs used in the On-Bill cost effectiveness methodology. Costs differ for the TDV methodology due to differences in the site gas infrastructure costs (see Section 2.6).

<sup>4</sup>This represents the Efficiency EDR Margin for the Efficiency-Non-Preempted and Efficiency-Equipment packages and Total EDR Margin for the Efficiency & PV, Efficiency & PV/Battery, and Neutral Cost packages.

<sup>5</sup>Positive values indicate an increase in PV capacity relative to the Standard Design.



**Climate Zone 15**

**Table 81: Single Family Climate Zone 15 Results Summary**

Climate Zone 15 SCE/SoCalGas Single Family		Annual Net kWh	Annual therms	EDR Margin <sup>4</sup>	PV Size Change (kW) <sup>5</sup>	CO2-Equivalent Emissions (lbs/sf)		NPV of Lifetime Incremental Cost (\$)	Benefit to Cost Ratio (B/C)	
						Total	Reduction		On-Bill	TDV
Mixed Fuel <sup>1</sup>	Code Compliant	0	149	n/a	n/a	1.69	n/a	n/a	n/a	n/a
	Efficiency-Non-Preempted	0	141	4.5	(0.43)	1.56	0.13	\$2,179	1.00	1.58
	Efficiency-Equipment	(0)	132	4.5	(0.45)	1.51	0.18	(\$936)	>1	>1
	Efficiency & PV/Battery	(3)	141	7.0	(0.34)	1.38	0.32	\$6,043	1.15	1.51
All-Electric <sup>2</sup>	Code Compliant	2,149	0	n/a	n/a	1.32	n/a	n/a	n/a	n/a
	Efficiency-Non-Preempted	1,230	0	5.5	0.00	1.12	0.20	\$4,612	1.12	1.58
	Efficiency-Equipment	866	0	7.0	0.00	1.04	0.28	\$2,108	3.30	4.47
	Efficiency & PV	1,030	0	6.0	0.12	1.10	0.22	\$5,085	1.12	1.57
	Efficiency & PV/Battery	(2)	0	13.0	0.83	0.84	0.48	\$11,382	1.16	1.54
Mixed Fuel to All-Electric <sup>3</sup>	Code Compliant	2,149	0	0.0	0.00	1.32	0.37	(\$5,349)	1.73	2.21
	Efficiency & PV	1,030	0	6.0	0.12	1.10	0.59	(\$264)	>1	>1
	Neutral Cost	23	0	6.0	1.36	1.13	0.57	\$0	>1	>1

<sup>1</sup>All reductions and incremental costs relative to the **mixed fuel** code compliant home.

<sup>2</sup>All reductions and incremental costs relative to the **all-electric** code compliant home.

<sup>3</sup>All reductions and incremental costs relative to the **mixed fuel** code compliant home except the EDR Margins are relative to the Standard Design for each case which is the **all-electric** code compliant home. Incremental costs for these packages reflect the costs used in the On-Bill cost effectiveness methodology. Costs differ for the TDV methodology due to differences in the site gas infrastructure costs (see Section 2.6).

<sup>4</sup>This represents the Efficiency EDR Margin for the Efficiency-Non-Preempted and Efficiency-Equipment packages and Total EDR Margin for the Efficiency & PV, Efficiency & PV/Battery, and Neutral Cost packages.

<sup>5</sup>Positive values indicate an increase in PV capacity relative to the Standard Design.



Table 82: Multifamily Climate Zone 15 Results Summary (Per Dwelling Unit)

Climate Zone 15 SCE/SoCalGas Multifamily		Annual Net kWh	Annual therms	EDR Margin <sup>4</sup>	PV Size Change (kW) <sup>5</sup>	CO2-Equivalent Emissions (lbs/sf)		NPV of Lifetime Incremental Cost (\$)	Benefit to Cost Ratio (B/C)	
						Total	Reduction		On-Bill	TDV
Mixed Fuel <sup>1</sup>	Code Compliant	0	93	n/a	n/a	2.53	n/a	n/a	n/a	n/a
	Efficiency-Non-Preempted	0	92	4.0	(0.15)	2.42	0.11	\$510	1.35	2.28
	Efficiency-Equipment	0	86	4.0	(0.16)	2.33	0.20	(\$157)	>1	>1
	Efficiency & PV/Battery	(3)	92	8.5	(0.10)	2.13	0.40	\$2,604	1.29	1.70
All-Electric <sup>2</sup>	Code Compliant	1,243	0	n/a	n/a	1.78	n/a	n/a	n/a	n/a
	Efficiency-Non-Preempted	954	0	4.0	0.00	1.61	0.17	\$1,011	1.50	2.28
	Efficiency-Equipment	764	0	6.0	0.00	1.50	0.29	\$1,954	1.24	1.72
	Efficiency & PV	548	0	7.0	0.24	1.50	0.28	\$1,826	1.43	2.07
	Efficiency & PV/Battery	(3)	0	16.5	0.62	1.08	0.70	\$5,020	1.34	1.80
Mixed Fuel to All-Electric <sup>3</sup>	Code Compliant	1,243	0	0.0	0.00	1.78	0.75	(\$2,337)	6.36	2.35
	Efficiency & PV	68	0	7.0	0.24	1.50	1.03	(\$511)	>1	>1
	Neutral Cost	78	0	7.5	0.70	1.48	1.05	\$0	>1	>1

<sup>1</sup>All reductions and incremental costs relative to the **mixed fuel** code compliant home.

<sup>2</sup>All reductions and incremental costs relative to the **all-electric** code compliant home.

<sup>3</sup>All reductions and incremental costs relative to the **mixed fuel** code compliant home except the EDR Margins are relative to the Standard Design for each case which is the **all-electric** code compliant home. Incremental costs for these packages reflect the costs used in the On-Bill cost effectiveness methodology. Costs differ for the TDV methodology due to differences in the site gas infrastructure costs (see Section 2.6).

<sup>4</sup>This represents the Efficiency EDR Margin for the Efficiency-Non-Preempted and Efficiency-Equipment packages and Total EDR Margin for the Efficiency & PV, Efficiency & PV/Battery, and Neutral Cost packages.

<sup>5</sup>Positive values indicate an increase in PV capacity relative to the Standard Design.



**Climate Zone 16**

**Table 83: Single Family Climate Zone 16 Results Summary**

Climate Zone 16 PG&E Single Family		Annual Net kWh	Annual therms	EDR Margin <sup>4</sup>	PV Size Change (kW) <sup>5</sup>	CO2-Equivalent Emissions (lbs/sf)		NPV of Lifetime Incremental Cost (\$)	Benefit to Cost Ratio (B/C)	
						Total	Reduction		On-Bill	TDV
Mixed Fuel <sup>1</sup>	Code Compliant	(0)	605	n/a	n/a	3.31	n/a	n/a	n/a	n/a
	Efficiency-Non-Preempted	0	454	5.0	0.01	2.59	0.72	\$3,542	1.62	1.46
	Efficiency-Equipment	0	474	6.0	(0.08)	2.66	0.65	\$2,441	2.19	2.20
	Efficiency & PV/Battery	(18)	454	10.5	0.10	2.36	0.95	\$7,399	<b>0.87</b>	1.37
All-Electric <sup>2</sup>	Code Compliant	7,694	0	n/a	n/a	1.73	n/a	n/a	n/a	n/a
	Efficiency-Non-Preempted	5,696	0	9.5	0.00	1.38	0.35	\$5,731	1.72	1.69
	Efficiency-Equipment	6,760	0	4.5	0.00	1.55	0.18	\$2,108	2.36	2.32
	Efficiency & PV	1,032	0	26.5	2.75	0.94	0.79	\$16,582	2.09	1.62
	Efficiency & PV/Battery	(11)	0	35.0	3.45	0.64	1.09	\$22,838	1.71	1.55
Mixed Fuel to All-Electric <sup>3</sup>	Code Compliant	7,694	0	0.0	0.00	1.73	1.58	(\$5,349)	<b>0.31</b>	<b>0.68</b>
	Efficiency & PV	1,032	0	26.5	2.75	0.94	2.37	\$11,234	1.55	2.02
	Neutral Cost	5,398	0	8.5	1.35	1.51	1.80	\$0	<b>0.00</b>	<b>0.74</b>
	Min Cost Effectiveness	3,358	0	16.0	2.56	1.32	1.99	(\$4,753)	1.24	1.40

<sup>1</sup>All reductions and incremental costs relative to the **mixed fuel** code compliant home.

<sup>2</sup>All reductions and incremental costs relative to the **all-electric** code compliant home.

<sup>3</sup>All reductions and incremental costs relative to the **mixed fuel** code compliant home except the EDR Margins are relative to the Standard Design for each case which is the **all-electric** code compliant home. Incremental costs for these packages reflect the costs used in the On-Bill cost effectiveness methodology. Costs differ for the TDV methodology due to differences in the site gas infrastructure costs (see Section 2.6).

<sup>4</sup>This represents the Efficiency EDR Margin for the Efficiency-Non-Preempted and Efficiency-Equipment packages and Total EDR Margin for the Efficiency & PV, Efficiency & PV/Battery, Neutral Cost, and Min Cost Effectiveness packages.

<sup>5</sup>Positive values indicate an increase in PV capacity relative to the Standard Design.



Table 84: Multifamily Climate Zone 16 Results Summary (Per Dwelling Unit)

Climate Zone 16 PG&E Multifamily		Annual Net kWh	Annual therms	EDR Margin <sup>4</sup>	PV Size Change (kW) <sup>5</sup>	CO2-Equivalent Emissions (lbs/sf)		NPV of Lifetime Incremental Cost (\$)	Benefit to Cost Ratio (B/C)	
						Total	Reduction		On-Bill	TDV
Mixed Fuel <sup>1</sup>	Code Compliant	0	206	n/a	n/a	3.45	n/a	n/a	n/a	n/a
	Efficiency-Non-Preempted	(0)	172	2.0	0.03	3.02	0.44	\$937	1.11	1.19
	Efficiency-Equipment	(0)	183	2.5	(0.02)	3.12	0.33	\$453	1.76	2.15
	Efficiency & PV/Battery	(9)	172	9.5	0.08	2.65	0.80	\$3,028	0.47	1.28
All-Electric <sup>2</sup>	Code Compliant	2,699	0	n/a	n/a	1.86	n/a	n/a	n/a	n/a
	Efficiency-Non-Preempted	2,329	0	4.0	0.00	1.70	0.16	\$843	2.08	2.05
	Efficiency-Equipment	2,470	0	3.0	0.00	1.74	0.13	\$795	1.59	1.70
	Efficiency & PV	518	0	19.5	1.07	1.23	0.63	\$4,423	2.58	1.89
	Efficiency & PV/Battery	(6)	0	29.5	1.42	0.75	1.11	\$7,533	1.65	1.69
Mixed Fuel to All-Electric <sup>3</sup>	Code Compliant	2,699	0	0.0	0.00	1.86	1.59	(\$2,337)	0.43	1.03
	Efficiency & PV	65	0	19.5	1.07	1.23	2.22	\$2,087	2.87	>1
	Neutral Cost	1,518	0	10.0	0.70	1.56	1.90	\$0	>1	2.58

<sup>1</sup>All reductions and incremental costs relative to the **mixed fuel** code compliant home.

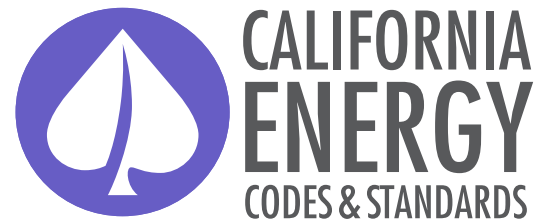
<sup>2</sup>All reductions and incremental costs relative to the **all-electric** code compliant home.

<sup>3</sup>All reductions and incremental costs relative to the **mixed fuel** code compliant home except the EDR Margins are relative to the Standard Design for each case which is the **all-electric** code compliant home. Incremental costs for these packages reflect the costs used in the On-Bill cost effectiveness methodology. Costs differ for the TDV methodology due to differences in the site gas infrastructure costs (see Section 2.6).

<sup>4</sup>This represents the Efficiency EDR Margin for the Efficiency-Non-Preempted and Efficiency-Equipment packages and Total EDR Margin for the Efficiency & PV, Efficiency & PV/Battery, and Neutral Cost packages.

<sup>5</sup>Positive values indicate an increase in PV capacity relative to the Standard Design.





A STATEWIDE UTILITY PROGRAM

Title 24, Parts 6 and 11  
Local Energy Efficiency Ordinances

## 2019 Nonresidential New Construction Reach Code Cost Effectiveness Study

**Prepared for:**  
Christopher Kuch  
Codes and Standards Program  
Southern California Edison Company

**Prepared by:**  
TRC  
EnergySoft

Last Modified: July 25, 2019



**LEGAL NOTICE**

This report was prepared by Southern California Edison Company (SCE) and funded by the California utility customers under the auspices of the California Public Utilities Commission.

Copyright 2019, Southern California Edison Company. All rights reserved, except that this document may be used, copied, and distributed without modification.

Neither SCE nor any of its employees makes any warranty, express or implied; or assumes any legal liability or responsibility for the accuracy, completeness or usefulness of any data, information, method, product, policy or process disclosed in this document; or represents that its use will not infringe any privately-owned rights including, but not limited to, patents, trademarks or copyrights.



## Table of Contents

1	Introduction .....	1
2	Methodology and Assumptions .....	3
2.1	Building Prototypes .....	3
2.2	Cost Effectiveness .....	5
3	Measure Description and Cost .....	7
3.1	Energy Efficiency Measures .....	7
3.1.1	Envelope .....	8
3.1.2	HVAC and SWH .....	8
3.1.3	Lighting .....	9
3.2	Solar Photovoltaics and Battery Measures .....	13
3.2.1	Solar Photovoltaics .....	13
3.2.2	Battery Storage .....	15
3.2.3	PV-only and PV+Battery Packages .....	16
3.3	All Electric Measures .....	16
3.3.1	HVAC and Water Heating .....	16
3.3.2	Infrastructure Impacts .....	20
3.4	Preempted High Efficiency Appliances .....	22
3.5	Greenhouse Gas Emissions .....	22
4	Results .....	23
4.1	Cost Effectiveness Results – Medium Office .....	24
4.2	Cost Effectiveness Results – Medium Retail .....	33
4.3	Cost Effectiveness Results – Small Hotel .....	41
4.4	Cost Effectiveness Results – PV-only and PV+Battery .....	50
5	Summary, Conclusions, and Further Considerations .....	55
5.1	Summary .....	55
5.2	Conclusions and Further Considerations .....	58
6	Appendices .....	60
6.1	Map of California Climate Zones .....	60
6.2	Lighting Efficiency Measures .....	61
6.3	Drain Water Heat Recovery Measure Analysis .....	61
6.4	Utility Rate Schedules .....	62
6.5	Mixed Fuel Baseline Energy Figures .....	63
6.6	Hotel TDV Cost Effectiveness with Propane Baseline .....	65
6.7	PV-only and PV+Battery-only Cost Effectiveness Results Details .....	69
6.7.1	Cost Effectiveness Results – Medium Office .....	69
6.7.2	Cost Effectiveness Results – Medium Retail .....	79
6.7.3	Cost Effectiveness Results – Small Hotel .....	88
6.8	List of Relevant Efficiency Measures Explored .....	97
6.9	Additional Rates Analysis - Healdsburg .....	102

## List of Figures

Figure 1. Measure Category and Package Overview .....	2
Figure 2. Prototype Characteristics Summary .....	4
Figure 3. Utility Tariffs used based on Climate Zone .....	6
Figure 4. Energy Efficiency Measures - Specification and Cost.....	10
Figure 5. Medium Office – Annual Percent kWh Offset with 135 kW Array .....	13
Figure 6. Medium Retail – Annual Percent kWh Offset with 110 kW Array.....	14
Figure 7. Small Hotel – Annual Percent kWh Offset with 80 kW Array .....	14
Figure 8. Medium Office Upfront PV Costs.....	15
Figure 9. All-Electric HVAC and Water Heating Characteristics Summary.....	17
Figure 10. Medium Office HVAC System Costs .....	18
Figure 11. Medium Retail HVAC System Costs .....	19
Figure 12. Small Hotel HVAC and Water Heating System Costs .....	20
Figure 13. Medium Office Electrical Infrastructure Costs for All-Electric Design .....	21
Figure 14. Natural Gas Infrastructure Cost Savings for All-Electric Prototypes.....	22
Figure 15. High Efficiency Appliance Assumptions .....	22
Figure 16. Package Summary .....	23
Figure 17. Cost Effectiveness for Medium Office Package 1A – Mixed-Fuel + EE .....	26
Figure 18. Cost Effectiveness for Medium Office Package 1B – Mixed-Fuel + EE + PV + B.....	27
Figure 19. Cost Effectiveness for Medium Office Package 1C – Mixed-Fuel + HE .....	28
Figure 20. Cost Effectiveness for Medium Office Package 2 – All-Electric Federal Code Minimum .....	29
Figure 21. Cost Effectiveness for Medium Office Package 3A – All-Electric + EE .....	30
Figure 22. Cost Effectiveness for Medium Office Package 3B – All-Electric + EE + PV + B .....	31
Figure 23. Cost Effectiveness for Medium Office Package 3C – All-Electric + HE .....	32
Figure 24. Cost Effectiveness for Medium Retail Package 1A – Mixed-Fuel + EE.....	34
Figure 25. Cost Effectiveness for Medium Retail Package 1B – Mixed-Fuel + EE + PV + B.....	35
Figure 26. Cost Effectiveness for Medium Retail Package 1C – Mixed-Fuel + HE.....	36
Figure 27. Cost Effectiveness for Medium Retail Package 2 – All-Electric Federal Code Minimum .....	37
Figure 28. Cost Effectiveness for Medium Retail Package 3A – All-Electric + EE.....	38
Figure 29. Cost Effectiveness for Medium Retail Package 3B – All-Electric + EE + PV + B.....	39
Figure 30. Cost Effectiveness for Medium Retail Package 3C – All-Electric + HE .....	40
Figure 31. Cost Effectiveness for Small Hotel Package 1A – Mixed-Fuel + EE .....	43
Figure 32. Cost Effectiveness for Small Hotel Package 1B – Mixed-Fuel + EE + PV + B .....	44
Figure 33. Cost Effectiveness for Small Hotel Package 1C – Mixed-Fuel + HE.....	45
Figure 34. Cost Effectiveness for Small Hotel Package 2 – All-Electric Federal Code Minimum .....	46
Figure 35. Cost Effectiveness for Small Hotel Package 3A – All-Electric + EE .....	47
Figure 36. Cost Effectiveness for Small Hotel Package 3B – All-Electric + EE + PV + B .....	48
Figure 37. Cost Effectiveness for Small Hotel Package 3C – All-Electric + HE.....	49
Figure 38. Cost Effectiveness for Medium Office - PV and Battery .....	52
Figure 39. Cost Effectiveness for Medium Retail - PV and Battery.....	53
Figure 40. Cost Effectiveness for Small Hotel - PV and Battery .....	54
Figure 41. Medium Office Summary of Compliance Margin and Cost Effectiveness .....	56
Figure 42. Medium Retail Summary of Compliance Margin and Cost Effectiveness.....	57
Figure 43. Small Hotel Summary of Compliance Margin and Cost Effectiveness .....	58
Figure 44. Map of California Climate Zones.....	60
Figure 45. Impact of Lighting Measures on Proposed LPDs by Space Function .....	61

Figure 46. Utility Tariffs Analyzed Based on Climate Zone – Detailed View .....	62
Figure 47. Medium Office – Mixed Fuel Baseline .....	63
Figure 48. Medium Retail – Mixed Fuel Baseline.....	64
Figure 49. Small Hotel – Mixed Fuel Baseline .....	65
Figure 50. TDV Cost Effectiveness for Small Hotel, Propane Baseline – Package 2 All-Electric Federal Code Minimum.....	66
Figure 51. TDV Cost Effectiveness for Small Hotel, Propane Baseline – Package 3A (All-Electric + EE) .....	67
Figure 52. TDV Cost Effectiveness for Small Hotel, Propane Baseline – Package 3B (All-Electric + EE + PV) .....	67
Figure 53. TDV Cost Effectiveness for Small Hotel, Propane Baseline – Package 3C (All Electric + HE) .....	68
Figure 54. Cost Effectiveness for Medium Office - Mixed Fuel + 3kW PV .....	71
Figure 55. Cost Effectiveness for Medium Office – Mixed Fuel + 3kW PV + 5 kWh Battery .....	72
Figure 56. Cost Effectiveness for Medium Office – Mixed Fuel + 135kW PV .....	73
Figure 57. Cost Effectiveness for Medium Office – Mixed Fuel + 135kW PV + 50 kWh Battery .....	74
Figure 58. Cost Effectiveness for Medium Office– All-Electric + 3kW PV .....	75
Figure 59. Cost Effectiveness for Medium Office – All-Electric + 3kW PV + 5 kWh Battery .....	76
Figure 60. Cost Effectiveness for Medium Office – All-Electric + 135kW PV .....	77
Figure 61. Cost Effectiveness for Medium Office – All-Electric + 135kW PV + 50 kWh Battery .....	78
Figure 62. Cost Effectiveness for Medium Retail – Mixed-Fuel + 3kW PV.....	80
Figure 63. Cost Effectiveness for Medium Retail – Mixed Fuel + 3kW PV + 5 kWh Battery.....	81
Figure 64. Cost Effectiveness for Medium Retail – Mixed-Fuel + 110kW PV .....	82
Figure 65. Cost Effectiveness for Medium Retail – Mixed-Fuel + 110 kW PV + 50 kWh Battery.....	83
Figure 66. Cost Effectiveness for Medium Retail – All-Electric + 3kW PV .....	84
Figure 67. Cost Effectiveness for Medium Retail – All-Electric + 3kW PV + 5 kWh Battery.....	85
Figure 68. Cost Effectiveness for Medium Retail – All-Electric + 110kW PV .....	86
Figure 69. Cost Effectiveness for Medium Retail – All-Electric + 110kW PV + 50 kWh Battery .....	87
Figure 70. Cost Effectiveness for Small Hotel – Mixed Fuel + 3kW PV .....	89
Figure 71. Cost Effectiveness for Small Hotel – Mixed Fuel + 3kW PV + 5 kWh Battery .....	90
Figure 72. Cost Effectiveness for Small Hotel - Mixed Fuel +80kW PV.....	91
Figure 73. Cost Effectiveness for Small Hotel – Mixed Fuel + 80kW PV + 50 kWh Battery .....	92
Figure 74. Cost Effectiveness for Small Hotel – All-Electric + 3kW PV.....	93
Figure 75. Cost Effectiveness for Small Hotel – All-Electric + 3kW PV + 5 kWh Battery.....	94
Figure 76. Cost Effectiveness for Small Hotel – All-Electric + 80kW PV.....	95
Figure 77. Cost Effectiveness for Small Hotel – All-Electric + 80kW PV + 50 kWh Battery.....	96
Figure 78. List of Relevant Efficiency Measures Explored .....	97
Figure 79. Healdsburg Utility Rates Analysis – Medium Office, All Packages Cost Effectiveness Summary.....	103
Figure 80. Healdsburg Utility Rates Analysis – Medium Retail, All Packages Cost Effectiveness Summary.....	104
Figure 81. Healdsburg Utility Rates Analysis – Small Hotel, All Packages Cost Effectiveness Summary .....	105

# 1 Introduction

The California Building Energy Efficiency Standards Title 24, Part 6 (Title 24) (CEC, 2019) is maintained and updated every three years by two state agencies: the California Energy Commission (the Energy Commission) and the Building Standards Commission (BSC). In addition to enforcing the code, local jurisdictions have the authority to adopt local energy efficiency ordinances—or reach codes—that exceed the minimum standards defined by Title 24 (as established by Public Resources Code Section 25402.1(h)2 and Section 10-106 of the Building Energy Efficiency Standards). Local jurisdictions must demonstrate that the requirements of the proposed ordinance are cost-effective and do not result in buildings consuming more energy than is permitted by Title 24. In addition, the jurisdiction must obtain approval from the Energy Commission and file the ordinance with the BSC for the ordinance to be legally enforceable. This report was developed in coordination with the California Statewide Investor Owned Utilities (IOUs) Codes and Standards Program, key consultants, and engaged cities—collectively known as the Reach Code Team.

This report documents cost-effective combinations of measures that exceed the minimum state requirements for design in newly-constructed nonresidential buildings. Buildings specifically examined include medium office, medium retail, and small hotels. Measures include energy efficiency, solar photovoltaics (PV), and battery storage. In addition, the report includes a comparison between a baseline mixed-fuel design and all-electric design for each occupancy type.

The Reach Code team analyzed the following seven packages as compared to 2019 code compliant mixed-fuel design baseline:

- ◆ **Package 1A – Mixed-Fuel + Energy Efficiency (EE):** Mixed-fuel design with energy efficiency measures and federal minimum appliance efficiencies.
- ◆ **Package 1B – Mixed-Fuel + EE + PV + Battery (B):** Same as Package 1A, plus solar PV and batteries.
- ◆ **Package 1C – Mixed-fuel + High Efficiency (HE):** Baseline code-minimum building with high efficiency appliances, triggering federal preemption. The intent of this package is to assess the standalone contribution that high efficiency appliances would make toward achieving high performance thresholds.
- ◆ **Package 2 – All-Electric Federal Code-Minimum Reference:** All-electric design with federal code minimum appliance efficiency. No solar PV or battery.
- ◆ **Package 3A – All-Electric + EE:** Package 2 all-electric design with energy efficiency measures and federal minimum appliance efficiencies.
- ◆ **Package 3B – All-Electric + EE + PV + B:** Same as Package 3A, plus solar PV and batteries.
- ◆ **Package 3C – All-Electric + HE:** All-electric design with high efficiency appliances, triggering federal preemption.

Figure 1 summarizes the baseline and measure packages. Please refer to *Section 3* for more details on the measure descriptions.

**Figure 1. Measure Category and Package Overview**

Measure Category	Report Section	Mixed Fuel				All-Electric			
		Baseline	1A	1B	1C	2	3A	3B	3C
		Fed Code Minimum Efficiency	EE	EE+ PV + B	HE	Fed Code Minimum Efficiency	EE	EE+ PV + B	HE
Energy Efficiency Measures	3.1		X	X			X	X	
Solar PV + Battery	3.2			X				X	
All-Electric Measures	3.3					X	X	X	X
Preemptive Appliance Measures	3.4				X				X

The team separately developed cost effectiveness results for PV-only and PV+Battery packages, excluding any efficiency measures. For these packages, the PV is modeled as a “minimal” size of 3 kW and a larger size based on the available roof area and electric load of the building. PV sizes are combined with two sizes of battery storage for both mixed fuel and all electric buildings to form eight different package combinations as outlined below:

- ◆ **Mixed-Fuel + 3 kW PV Only**
- ◆ **Mixed-Fuel + 3 kW PV + 5 kWh Battery**
- ◆ **Mixed-Fuel + PV Only:** PV sized per the roof size of the building, or to offset the annual electricity consumption, whichever is smaller
- ◆ **Mixed-Fuel + PV + 50 kWh Battery:** PV sized per the roof size of the building, or to offset the annual electricity consumption, whichever is smaller, along with 50 kWh battery
- ◆ **All-Electric + 3 kW PV Only**
- ◆ **All-Electric + 3 kW PV + 5 kWh Battery**
- ◆ **All-Electric + PV Only:** PV sized per the roof size of the building, or to offset the annual electricity consumption, whichever is smaller
- ◆ **All-Electric + PV + 50 kWh Battery:** PV sized per the roof size of the building, or to offset the annual electricity consumption, whichever is smaller, along with 50 kWh battery.

Each of the eight packages are evaluated against a baseline model designed as per 2019 Title 24 Part 6 requirements. The Standards baseline for all occupancies in this report is a mixed-fuel design.

The Department of Energy (DOE) sets minimum efficiency standards for equipment and appliances that are federally regulated under the National Appliance Energy Conservation Act (NAECA), including heating, cooling, and water heating equipment.<sup>1</sup> Since state and local governments are prohibited from adopting

<sup>1</sup> [https://www.ecfr.gov/cgi-bin/retrieveECFR?gp=&SID=8de751f141aaa1c1c9833b36156faf67&mc=true&n=pt10.3.431&r=PART&ty=HTML#se10.3.431\\_197](https://www.ecfr.gov/cgi-bin/retrieveECFR?gp=&SID=8de751f141aaa1c1c9833b36156faf67&mc=true&n=pt10.3.431&r=PART&ty=HTML#se10.3.431_197)



higher minimum efficiencies than the federal standards require, the focus of this study is to identify and evaluate cost-effective packages that do not include high efficiency equipment. However, because high efficiency appliances are often the easiest and most affordable measures to increase energy performance, this study provides an analysis of high efficiency appliances for informational purposes. While federal preemption would limit a reach code, in practice, builders may install any package of compliant measures to achieve the performance requirements, including higher efficiency appliances that are federally regulated.

## 2 Methodology and Assumptions

With input from several stakeholders, the Reach Codes team selected three building types—medium office, medium retail, and small hotel—to represent a predominant segment of nonresidential new construction in the state.

This analysis used both on-bill and time dependent valuation of energy (TDV) based approaches to evaluate cost-effectiveness. Both methodologies require estimating and quantifying the energy savings associated with energy efficiency measures, as well as quantifying the costs associated with the measures. The main difference between the methodologies is the valuation of energy and thus the cost savings of reduced or avoided energy use. TDV was developed by the Energy Commission to reflect the time dependent value of energy including long-term projected costs of energy such as the cost of providing energy during peak periods of demand and other societal costs including projected costs for carbon emissions. With the TDV approach, electricity used (or saved) during peak periods has a much higher value than electricity used (or saved) during off-peak periods.<sup>2</sup>

The Reach Code Team performed energy simulations using EnergyPro 8.0 software for 2019 Title 24 code compliance analysis, which uses CBECC-Com 2019.1.0 for the calculation engine. The baseline prototype models in all climate zones have been designed to have compliance margins as close as possible to 0 to reflect a prescriptively-built building.<sup>3</sup>

### 2.1 Building Prototypes

The DOE provides building prototype models which, when modified to comply with 2019 Title 24 requirements, can be used to evaluate the cost effectiveness of efficiency measures. These prototypes have historically been used by the California Energy Commission to assess potential code enhancements. The Reach Code Team performed analysis on a medium office, a medium retail, and a small hotel prototype.

Water heating includes both service water heating (SWH) for office and retail buildings and domestic hot water for hotels. In this report, water heating or SWH is used to refer to both. The Standard Design HVAC and SWH systems are based on the system maps included in the 2019 Nonresidential Alternate

---

<sup>2</sup> Horii, B., E. Cutter, N. Kapur, J. Arent, and D. Conotyannis. 2014. "Time Dependent Valuation of Energy for Developing Building Energy Efficiency Standards." Available at: [http://www.energy.ca.gov/title24/2016standards/prerulemaking/documents/2014-07-09\\_workshop/2017\\_TDV\\_Documents](http://www.energy.ca.gov/title24/2016standards/prerulemaking/documents/2014-07-09_workshop/2017_TDV_Documents)

<sup>3</sup> EnergySoft and TRC were able to develop most baseline prototypes to achieve a compliance margin of less than +/-1 percent except for few models that were at +/- 6 percent. This indicates these prototypes are not exactly prescriptive according to compliance software calculations. To calculate incremental impacts, TRC conservatively compared the package results to that of the proposed design of baseline prototypes (not the standard design).

Calculation Method Reference Manual.<sup>4</sup> The Standard Design is the baseline for all nonresidential projects and assumes a mixed-fuel design using natural gas as the space heating source in all cases. Baseline HVAC and SWH system characteristics are described below and in Figure 2:

- ◆ The baseline medium office HVAC design package includes two gas hot water boilers, three packaged rooftop units (one for each floor), and variable air volume (VAV) terminal boxes with hot water reheat coils. The SWH design includes one 8.75 kW electric resistance hot water heater with a 30-gallon storage tank.
- ◆ The baseline medium retail HVAC design includes five single zone packaged rooftop units (variable flow and constant flow depending on the zone) with gas furnaces for heating. The SWH design includes one 8.75 kW electric resistance hot water heater with a 30-gallon storage tank.
- ◆ The small hotel has two baseline equipment systems, one for the nonresidential spaces and one for the guest rooms.
  - ◆ The nonresidential HVAC design includes two gas hot water boilers, four packaged rooftop units and twelve VAV terminal boxes with hot water reheat coils. The SWH design include a small electric resistance water heater with 30-gallon storage tank.
  - ◆ The residential HVAC design includes one single zone air conditioner (AC) unit with gas furnace for each guest room and the water heating design includes one central gas water heater with a recirculation pump for all guest rooms.

**Figure 2. Prototype Characteristics Summary**

	Medium Office	Medium Retail	Small Hotel
<b>Conditioned Floor Area</b>	53,628	24,691	42,552
<b>Number of Stories</b>	3	1	4
<b>Number of Guest Rooms</b>	0	0	78
<b>Window-to-Wall Area Ratio</b>	0.33	0.07	0.11
<b>Baseline HVAC System</b>	Packaged DX VAV with gas furnaces + VAV terminal units with hot water reheat. Central gas hot water boilers	Single zone packaged DX units with gas furnaces	<u>Nonresidential:</u> Packaged DX VAV with hot water coil + VAV terminal units with hot water reheat. Central gas hot water boilers. <u>Residential:</u> Single zone DX AC unit with gas furnaces
<b>Baseline Water Heating System</b>	30-gallon electric resistance water heater	30-gallon electric resistance water heater	<u>Nonresidential:</u> 30-gallon electric resistance water heater <u>Residential:</u> Central gas water heater with recirculation loop

<sup>4</sup> Nonresidential Alternative Calculation Method Reference Manual For the 2019 Building Energy Efficiency Standards. Available at: <https://www.energy.ca.gov/2019publications/CEC-400-2019-006/CEC-400-2019-006-CMF.pdf>



## 2.2 Cost Effectiveness

The Reach Code Team analyzed the cost effectiveness of the packages by applying them to building prototypes (as applicable) using the life cycle cost methodology, which is approved and used by the Energy Commission to establish cost effective building energy standards (Title 24, Part 6).<sup>5</sup>

Per Energy Commission's methodology, the Reach Code Team assessed the incremental costs of the energy efficiency measure packages and compared them to the energy cost savings over the measure life of 15 years. Incremental costs represent the equipment, installation, replacements, and maintenance costs of the proposed measure relative to the 2019 Title 24 Standards minimum requirements. The energy savings benefits are estimated using both TDV of energy and typical utility rates for each building type:

- ◆ **Time Dependent Valuation:** TDV is a normalized monetary format developed and used by the Energy Commission for comparing electricity and natural gas savings, and it considers the cost of electricity and natural gas consumed during different times of the day and year. Simulation outputs are translated to TDV savings benefits using 2019 TDV multipliers and 15-year discounted costs for the nonresidential measure packages.
- ◆ **Utility bill impacts (On-bill):** Utility energy costs are estimated by applying appropriate IOU rates to estimated annual electricity and natural gas consumption. The energy bill savings are calculated as the difference in utility costs between the baseline and proposed package over a 15-year duration accounting for discount rate and energy cost escalation.

In coordination with the IOU rate team, and rate experts at a few electric publicly owned utilities (POUs), the Reach Code Team used the current nonresidential utility rates publicly available at the time of analysis to analyze the cost effectiveness for each proposed package. The utility tariffs, summarized in Figure 3, were determined based on the annual load profile of each prototype, and the most prevalent rate in each territory. For some prototypes there are multiple options for rates because of the varying load profiles of mixed-fuel buildings versus all-electric buildings. Tariffs were integrated in EnergyPro software to be applied to the hourly electricity and gas outputs. The Reach Code Team did not attempt to compare or test a variety of tariffs to determine their impact on cost effectiveness.

The currently available and applicable time-of-use (TOU) nonresidential rates are applied to both the base and proposed cases with PV systems.<sup>6</sup> Any annual electricity production in excess of annual electricity consumption is credited at the applicable wholesale rate based on the approved NEM tariffs for that utility. For a more detailed breakdown of the rates selected refer to *Appendix 6.4 Utility Rate Schedules*. Note that most utility time-of-use rates will be updated in the near future, which can affect cost effectiveness results. For example, Pacific Gas and Electric Company (PG&E) will introduce new rates for new service connections in late 2019, and existing accounts will be automatically rolled over to new rates in November 2020.

---

<sup>5</sup> Architectural Energy Corporation (January 2011) Life-Cycle Cost Methodology. California Energy Commission. Available at: [http://www.energy.ca.gov/title24/2013standards/prerulemaking/documents/general\\_cec\\_documents/2011-01-14\\_LCC\\_Methodology\\_2013.pdf](http://www.energy.ca.gov/title24/2013standards/prerulemaking/documents/general_cec_documents/2011-01-14_LCC_Methodology_2013.pdf)

<sup>6</sup> Under NEM rulings by the CPUC (D-16-01-144, 1/28/16), all new PV customers shall be in an approved TOU rate structure. As of March 2016, all new PG&E net energy metering (NEM) customers are enrolled in a time-of-use rate. (<http://www.pge.com/en/myhome/saveenergymoney/plans/tou/index.page?>).



**Figure 3. Utility Tariffs used based on Climate Zone**

Climate Zones	Electric / Gas Utility	Electricity (Time-of-use)	Natural Gas
<b>IOUs</b>			
1-5,11-13,16	PG&E	A-1/A-10	G-NR1
5	PG&E / Southern California Gas Company	A-1/A-10	G-10 (GN-10)
6,8-10,14,15	SCE / Southern California Gas Company	TOU-GS-1/TOU-GS-2/TOU-GS-3	G-10 (GN-10)
7,10,14	San Diego Gas and Electric Company (SDG&E)	A-1/A-10	GN-3
<b>Electric POUs</b>			
4	City of Palo Alto (CPAU)	E-2	n/a
12	Sacramento Municipal Utility District (SMUD)	GS	n/a
6,7,8,16	Los Angeles Department of Water and Power (LADWP)	A-2 (B)	n/a

The Reach Code Team obtained measure costs through interviews with contractors and California distributors and review of online sources, such as Home Depot and RS Means. Taxes and contractor markups were added as appropriate. Maintenance costs were not included because there is no assumed maintenance on the envelope measures. For HVAC and SWH measures the study assumes there are no additional maintenance cost for a more efficient version of the same system type as the baseline. Replacement costs for inverters were included for PV systems, but the useful life all other equipment exceeds the study period.

The Reach Code Team compared the energy benefits with incremental measure cost data to determine cost effectiveness for each measure package. The calculation is performed for a duration of 15 years for all nonresidential prototypes with a 3 percent discount rate and fuel escalation rates based on the most recent General Rate Case filings and historical escalation rates.<sup>7</sup> Cost effectiveness is presented using net present value and benefit-to-cost ratio metrics.

- ◆ **Net Present Value (NPV):** The Reach Code Team uses net savings (NPV benefits *minus* NPV costs) as the cost effectiveness metric. If the net savings of a measure or package is positive, it is considered cost effective. Negative savings represent net costs. A measure that has negative energy cost benefits (energy cost increase) can still be cost effective if the costs to implement the measure are more negative (i.e., material and maintenance cost savings).
- ◆ **Benefit-to-Cost Ratio (B/C):** Ratio of the present value of all benefits to the present value of all costs over 15 years (NPV benefits *divided by* NPV costs). The criteria for cost effectiveness is a B/C greater than 1.0. A value of one indicates the savings over the life of the measure are equivalent to the incremental cost of that measure.

<sup>7</sup> 2019 TDV Methodology Report, California Energy Commission, Docket number: 16-BSTD-06 <https://efiling.energy.ca.gov/GetDocument.aspx?tn=216062>



There are several special circumstances to consider when reviewing these results:

- ◆ Improving the efficiency of a project often requires an initial incremental investment. However, some packages result in initial construction cost savings (negative incremental cost), and either energy cost savings (positive benefits), or increased energy costs (negative benefits). Typically, utility bill savings are categorized as a ‘benefit’ while incremental construction costs are treated as ‘costs.’ In cases where both construction costs are negative and utility bill savings are negative, the construction cost savings are treated as the ‘benefit’ while the utility bill negative savings are the ‘cost.’
- ◆ In cases where a measure package is cost effective immediately (i.e., there are upfront cost savings and lifetime energy cost savings), cost effectiveness is represented by “>1”.
- ◆ The B/C ratios sometimes appear very high even though the cost numbers are not very high (for example, an upfront cost of \$1 but on-bill savings of \$200 over 30 years would equate to a B/C ratio of 200). NPV is also displayed to clarify these potentially confusing conclusions – in the example, the NPV would be equal to a modest \$199.

### 3 Measure Description and Cost

Using the 2019 Title 24 code baseline as the starting point, The Reach Code Team identified potential measure packages to determine the projected energy (therm and kWh) and compliance impacts. The Reach Code Team developed an initial measure list based on experience with designers and contractors along with general knowledge of the relative acceptance and preferences of many measures, as well as their incremental costs.

The measures are categorized into energy efficiency, solar PV and battery, all-electric, and preempted high efficiency measures in subsections below.

#### 3.1 Energy Efficiency Measures

This section describes all the energy efficiency measures considered for this analysis to develop a non-preempted, cost-effective efficiency measure package. The Reach Code Team assessed the cost-effectiveness of measures for all climate zones individually and found that the packages did not need to vary by climate zone, with the exception of a solar heat gain coefficient measure in hotels, as described in more detail below. The measures were developed based on reviews of proposed 2022 Title 24 codes and standards enhancement measures, as well as ASHRAE 90.1 and ASHRAE 189.1 Standards. Please refer to *Appendix Section 6.86.7* for a list of efficiency measures that were considered but not implemented.

Figure 4 provides a summary of the cost of each measure and the applicability of each measure to the prototype buildings.

### 3.1.1 Envelope

- ◆ **Modify Solar Heat Gain Coefficient (SHGC) fenestration**
  - ◆ Office and Retail - All Climate Zones: reduce window SHGC from the prescriptive value of 0.25 to 0.22
  - ◆ Hotel
    - ◆ Climate zones 1, 2, 3, 5, and 16: Increase the SHGC for all nonresidential spaces from the prescriptive value of 0.25 to 0.45 in both common and guest room spaces.
    - ◆ Climate zones 4, and 6-15: Reduce window SHGC from the prescriptive value of 0.25 to 0.22, only for common spaces.

In all cases, the fenestration visible transmittance and U-factor remain at prescriptive values.

- ◆ **Fenestration as a function of orientation:** Limit the amount of fenestration area as a function of orientation. East-facing and west-facing windows are each limited to one-half of the average amount of north-facing and south-facing windows.

### 3.1.2 HVAC and SWH

- ◆ **Drain water heat recovery (DWHR):** Add shower drain heat recovery in hotel guest rooms. DWHR captures waste heat from a shower drain line and uses it to preheat hot water. Note that this measure cannot currently be modeled on hotel/motel spaces, and the Reach Code Team integrated estimated savings outside of modeling software based on SWH savings in residential scenarios. Please see *Appendix Section 6.3* for details on energy savings analysis.
- ◆ **VAV box minimum flow:** Reduce VAV box minimum airflows from the current T24 prescriptive requirement of 20 percent of maximum (design) airflow to the T24 zone ventilation minimums.
- ◆ **Economizers on small capacity systems:** Require economizers and staged fan control in units with cooling capacity  $\geq 33,000$  Btu/hr and  $\leq 54,000$  Btu/hr, which matches the requirement in the 2018 International Green Construction Code and adopts ANSI/ASHRAE/ICC/USGBC/IES Standard 189.1. This measure reduces the T24 prescriptive threshold on air handling units that are required to have economizers, which is  $> 54,000$  Btu/hr.
- ◆ **Solar thermal hot water:** For all-electric hotel only, add solar thermal water heating to supply the following portions of the water heating load, measured in solar savings fraction (SSF):
  - ◆ 20 percent SSF in CZs 2, 3, and 5-9
  - ◆ 25 percent in CZ4
  - ◆ 35 percent SSF in CZs 1 and 10-16.



### 3.1.3 Lighting

- ◆ **Interior lighting reduced lighting power density (LPD):** Reduce LPD by 15 percent for Medium Office, 10 percent for Medium Retail and by 10 percent for the nonresidential areas of the Small Hotel.
- ◆ **Institutional tuning:** Limit the maximum output or maximum power draw of lighting to 85 percent of full light output or full power draw.
- ◆ **Daylight dimming plus off:** Turn daylight-controlled lights completely off when the daylight available in the daylit zone is greater than 150 percent of the illuminance received from the general lighting system at full power. There is no associated cost with this measure, as the 2019 T24 Standards already require multilevel lighting and daylight sensors in primary and secondary daylit spaces. This measure is simply a revised control strategy and does not increase the number of sensors required or labor to install and program a sensor.
- ◆ **Occupant sensing in open plan offices:** In an open plan office area greater than 250 ft<sup>2</sup>, control lighting based on occupant sensing controls. Two workstations per occupancy sensor.

Details on the applicability and impact of each measure by building type and by space function can be found in *Appendices 6.2*. The appendix also includes the resulting LPD that is modeled as the proposed by building type and by space function.



**Figure 4. Energy Efficiency Measures - Specification and Cost**

Measure	Baseline T24 Requirement	Measure Applicability				Incremental Cost	Sources & Notes
		• Included in Packages 1A, 1B, 3A, 3C – Not applicable					
		Med Office	Med Retail	Small Hotel			
Guest rooms	Comm Spaces						
Envelope							
Modify SHGC Fenestration	SHGC of 0.25	•	•	•	•	\$1.60 /ft <sup>2</sup> window for SHGC decreases, \$0/ft <sup>2</sup> for SHGC increases	Costs from one manufacturer.
Fenestration as a Function of Orientation	Limit on total window area and west-facing window area as a function of wall area.	•	–	–	–	\$0	No additional cost associated with the measure which is a design consideration not an equipment cost.
HVAC and SHW							
Drain Water Heat Recovery	No heat recovery required	–	–	•	–	\$841 /unit	Assume 1 heat recovery unit for every 3 guestrooms. Costs from three manufacturers.
VAV Box Minimum Flow	20 percent of maximum (design) airflow	•	–	–	•	\$0	No additional cost associated with the measure which is a design consideration not an equipment cost.
Economizers on Small Capacity Systems	Economizers required for units > 54,000 Btu/hr	–	•	–	–	\$2,857 /unit	Costs from one manufacturer's representative and one mechanical contractor.



Measure	Baseline T24 Requirement	Measure Applicability				Incremental Cost	Sources & Notes
		• Included in Packages 1A, 1B, 3A, 3C – Not applicable					
		Med Office	Med Retail	Small Hotel			
Guest rooms	Comm Spaces						
Solar Thermal Hot Water	For central heat pump water heaters, there is no prescriptive baseline requirement.	–	–	• (electric only)	–	\$33/therm-yr	Installed costs reported in the California Solar Initiative Thermal Program Database, 2015-present. <sup>8</sup> Costs include tank and were only available for gas backup systems. Costs are reduced by 19 percent per federal income tax credit average through 2022.
<b>Lighting</b>							
Interior Lighting Reduced LPD	Per Area Category Method, varies by Primary Function Area. Office area 0.60 – 0.70 W/ft <sup>2</sup> depending on area of space. Hotel function area 0.85 W/ft <sup>2</sup> . Retail Merchandise Sales 1.00 W/ft <sup>2</sup>	•	•	–	•	\$0	Industry report on LED pricing analysis shows that costs are not correlated with efficacy. <sup>9</sup>

<sup>8</sup> <http://www.csithermalstats.org/download.html>

<sup>9</sup> [http://calmac.org/publications/LED\\_Pricing\\_Analysis\\_Report\\_-\\_Revised\\_1.19.2018\\_Final.pdf](http://calmac.org/publications/LED_Pricing_Analysis_Report_-_Revised_1.19.2018_Final.pdf)



Measure	Baseline T24 Requirement	Measure Applicability				Incremental Cost	Sources & Notes
		• Included in Packages 1A, 1B, 3A, 3C – Not applicable					
		Med Office	Med Retail	Small Hotel			
Guest rooms	Comm Spaces						
Institutional Tuning	No requirement, but Power Adjustment Factor (PAF) credit of 0.10 available for luminaires in non-daylit areas and 0.05 for luminaires in daylit areas <sup>10</sup>	•	•	–	•	\$0.06/ft <sup>2</sup>	Industry report on institutional tuning <sup>11</sup>
Daylight Dimming Plus Off	No requirement, but PAF credit of 0.10 available.	•	–	–	–	\$0	Given the amount of lighting controls already required, this measure is no additional cost.
Occupant Sensing in Open Plan Offices	No requirement, but PAF credit of 0.30 available.	•	–	–	–	\$189 /sensor; \$74 /powered relay; \$108 /secondary relay	2 workstations per sensor; 1 fixture per workstation; 4 workstations per master relay; 120 ft <sup>2</sup> /workstation in open office area, which is 53% of total floor area of the medium office

<sup>10</sup> Power Adjustment Factors allow designers to tradeoff increased lighting power densities for more efficient designs. In this study, PAF-related measures assume that the more efficient design is incorporated without a tradeoff for increased lighting power density.

<sup>11</sup> <https://slipstreaminc.org/sites/default/files/2018-12/task-tuning-report-mndoc-2015.pdf>



### 3.2 Solar Photovoltaics and Battery Measures

This section describes the PV and battery measures considered for this analysis. The Reach Code Team estimated the required PV sizes for each building prototype for the efficiency measure packages and the stand alone PV and battery options.

#### 3.2.1 Solar Photovoltaics

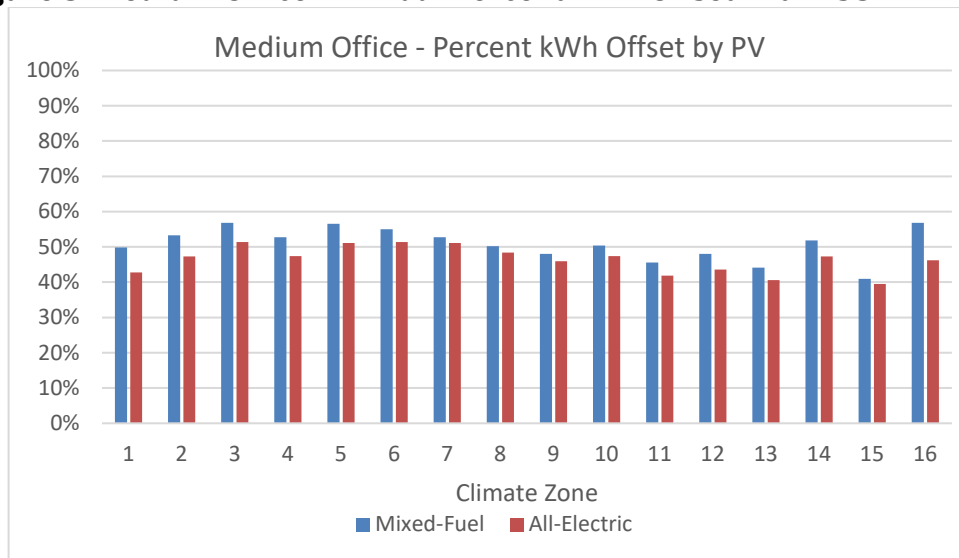
2019 Title 24 requires nonresidential buildings to reserve at least 15 percent of the roof area as a “solar zone,” but does not include any requirements or compliance credits for the installation of photovoltaic systems. The Reach Code Team analyzed a range of PV system sizes to determine cost effectiveness. To determine upper end of potential PV system size, the Reach Code Team assumed a PV generation capacity of either

- ◆ 15 W/ft<sup>2</sup> covering 50 percent of the roof area, or
- ◆ Enough to nearly offset the annual energy consumption.

The medium office and small hotel prototypes had small roof areas compared to their annual electricity demand, thus the PV system capacity at 50 percent of the roof area was less than the estimated annual usage. The medium office and small hotel had a 135 kW and 80 kW array, respectively. The medium retail building has a substantially large roof area that would accommodate a PV array that generates more than the annual electricity load of the building. The PV array for the medium retail building was sized at 110 kW to not exceed the annual electricity consumption of the building when accounting for the minimum annual energy demand across climate zones with efficiency packages.

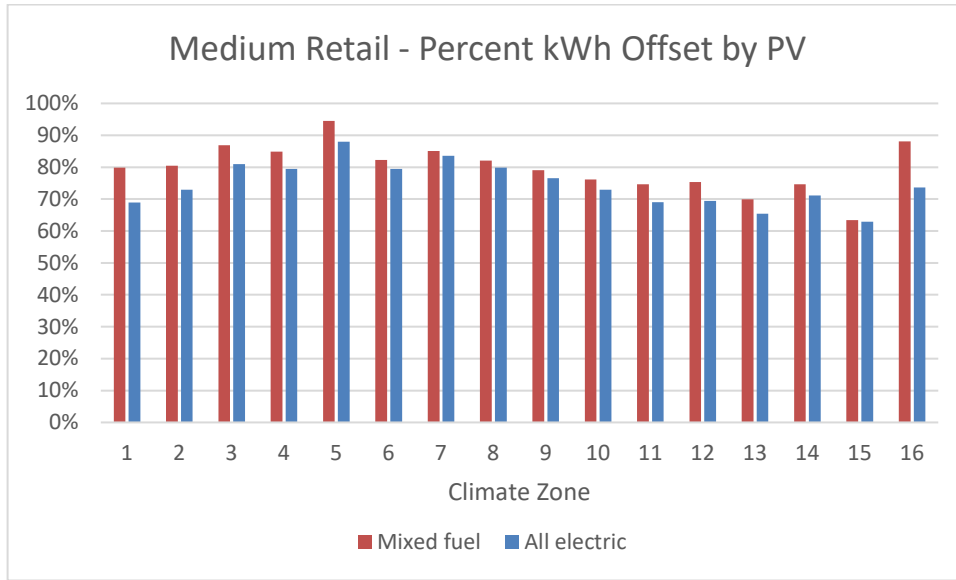
The modeling software for nonresidential buildings does not allow auto-sizing of PV based on a desired percent offset of electricity use. Moreover, the PV size is also constrained by the availability of roof area. Hence, a common size of PV is modeled for all the packages including all electric design. Figure 5 through Figure 7 below demonstrate the percent of electricity offset by PV for both mixed fuel and all electric buildings over their respective federal minimum design package.

**Figure 5. Medium Office – Annual Percent kWh Offset with 135 kW Array**

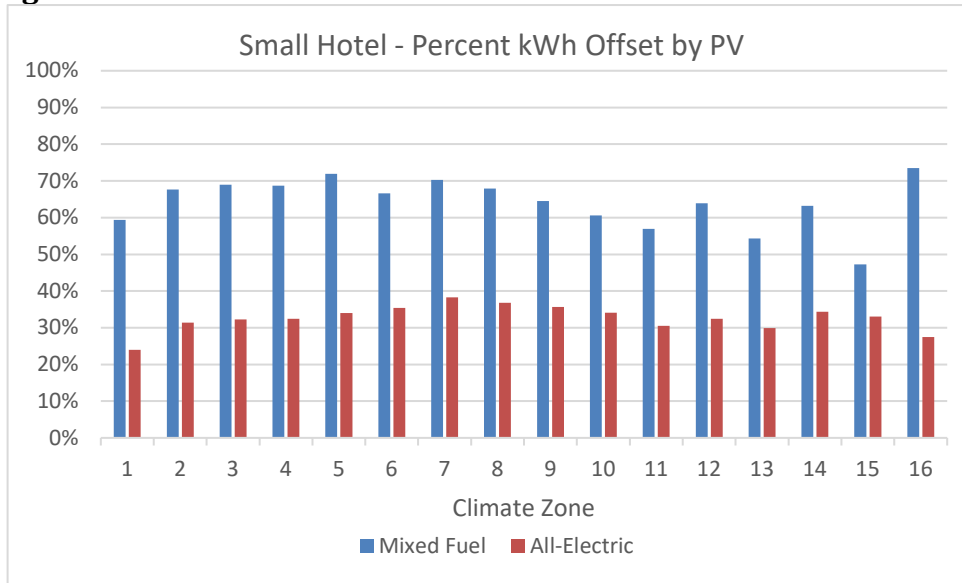




**Figure 6. Medium Retail – Annual Percent kWh Offset with 110 kW Array**



**Figure 7. Small Hotel – Annual Percent kWh Offset with 80 kW Array**



The costs for PV include first cost to purchase and install the system, inverter replacement costs, and annual maintenance costs. A summary of the medium office costs and sources is given in Figure 8. Upfront solar PV system costs are reduced by the federal income tax credit (ITC), approximately 19 percent due to a phased reduction in the credit through the year 2022.<sup>12</sup>

<sup>12</sup> The federal credit drops to 26% in 2020, and 22% in 2021 before dropping permanently to 10% for commercial projects and 0% for residential projects in 2022. More information on federal Investment Tax Credits available at: <https://www.seia.org/initiatives/solar-investment-tax-credit-itc>



**Figure 8. Medium Office Upfront PV Costs**

	Unit Cost	Cost	Useful Life (yrs.)	Source
Solar PV System	\$2.30 / Wdc	\$310,500	30	National Renewable Energy Laboratory (NREL) Q1 2016 <sup>13</sup>
Inverter Replacement	\$0.15 / Wdc	\$20,250	10	E3 Rooftop Solar PV System Report <sup>14</sup>
Maintenance Costs	\$0.02 / Wdc	\$2,700	1	

PV energy output is built into CBECC-Com and is based on NREL's PVWatts calculator, which includes long term performance degradation estimates.<sup>15</sup>

### 3.2.2 Battery Storage

This measure includes installation of batteries to allow energy generated through PV to be stored and used later, providing additional energy cost benefits. This report does not focus on optimizing battery sizes or controls for each prototype and climate zone, though the Reach Code Team ran test simulations to assess the impact of battery sizes on TDV savings and found diminishing returns as the battery size increased.

The team set battery control to the Time of Use Control (TOU) method, which assumes batteries are charged anytime PV generation is greater than the building load but discharges to the electric grid beginning during the highest priced hours of the day (the "First Hour of the Summer Peak"). Because there is no default hour available in CBECC-Com, the team applied the default hour available in CBECC-Res to start discharging (hour 19 in CZs 2, 4, and 8-15, and hour 20 in other CZs). This control option is most reflective of the current products on the market. While this control strategy is being used in the analysis, there would be no mandate on the control strategy used in practice.

The current simulation software has approximations of how performance characteristics change with environmental conditions, charge/discharge rates, and degradation with age and use. More information on the software battery control capabilities and associated qualification requirements are available in the Residential Alternative Calculation Method Reference Manual and the 2019 Reference Appendices for the 2019 Title 24 Standards.<sup>16,17</sup>

The Reach Code Team used costs of \$558 kWh based on a 2018 IOU Codes and Standards Program report, assuming a replacement is necessary in year 15.<sup>18</sup> Batteries are also eligible for the ITC if they are installed at the same time as the renewable generation source and at least 75 percent of the energy used to charge

<sup>13</sup> Available at: <https://www.nrel.gov/docs/fy16osti/66532.pdf>

<sup>14</sup> Available at: <https://efiling.energy.ca.gov/getdocument.aspx?tn=221366>

<sup>15</sup> More information available at: <https://pvwatts.nrel.gov/downloads/pvwattsv5.pdf>

<sup>16</sup> Battery controls are discussed in Sections 2.1.5.4 and Appendix D of the Residential Alternative Calculation Method Reference Manual, available here: <https://ww2.energy.ca.gov/2019publications/CEC-400-2019-005/CEC-400-2019-005-CMF.pdf>

<sup>17</sup> Qualification Requirements for Battery Storage Systems are available in JA12 of the 2019 Reference Appendices: <https://ww2.energy.ca.gov/2018publications/CEC-400-2018-021/CEC-400-2018-021-CMF.pdf>

<sup>18</sup> Available at: [http://localenergycodes.com/download/430/file\\_path/fieldList/PV%20Plus%20Battery%20Storage%20Report](http://localenergycodes.com/download/430/file_path/fieldList/PV%20Plus%20Battery%20Storage%20Report)



the battery comes from a renewable source. Thus, the Reach Code Team also applied a 19 percent cost reduction to battery costs.

### **3.2.3 PV-only and PV+Battery Packages**

The Reach Code Team analyzed solar PV and battery storage only, without other efficiency measures in both mixed-fuel and all-electric building designs. Two different sizes of solar PV and battery storage were analyzed.

- ◆ **Small PV Size:** 3 kW, assumed to be the minimal PV system considered for installation in a nonresidential building.
- ◆ **Large PV Size:** PV capacity equal to 15 W/ft<sup>2</sup> over 50 percent of the roof area, or sized to nearly offset annual electricity consumption, as described in Section 3.2.1.
- ◆ **Small Battery Size:** 5 kWh, assumed to be the minimal battery system considered for installation in a nonresidential building, and representative of smaller products currently available on the market.
- ◆ **Large Battery Size:** 50 kWh, assumed to be a substantially large size for a nonresidential setting. Generally, the reach code team found diminishing on-bill and TDV benefits as the battery size increased.

As described in Section 1 and Section 4.4, each PV size was run as a standalone measure. When packaged with a battery measure, the small PV size was paired with the small battery size, and the large PV size was paired with the large battery size.

## **3.3 All Electric Measures**

The Reach Code Team investigated the cost and performance impacts and associated infrastructure costs associated with changing the baseline HVAC and water heating systems to all-electric equipment. This includes heat pump space heating, electric resistance reheat coils, electric water heater with storage tank, heat pump water heating, increasing electrical capacity, and eliminating natural gas connections that would have been present in mixed-fuel new construction. The Reach Code Team selected electric systems that would be installed instead of gas-fueled systems in each prototype.

### **3.3.1 HVAC and Water Heating**

The nonresidential standards use a mixed-fuel baseline for the Standard Design systems. In most nonresidential occupancies, the baseline is natural gas space heating. Hotel/motels and high-rise residential occupancies also assume natural gas baseline water heating systems for the guest rooms and dwelling units. In the all-electric scenario, gas equipment serving these end-uses is replaced with electric equipment, as described in Figure 9.



**Figure 9. All-Electric HVAC and Water Heating Characteristics Summary.**

		Medium Office	Medium Retail	Small Hotel
<b>HVAC System</b>	Baseline	Packaged DX + VAV with HW reheat. Central <b>gas</b> boilers.	Single zone packaged DX with <b>gas</b> furnaces	<u>NonRes</u> : Packaged DX + VAV with HW reheat. Central <b>gas</b> boilers. <u>Res</u> : Single zone DX AC unit with <b>gas</b> furnaces
	Proposed All-Electric	Packaged DX + VAV with electric <b>resistance</b> reheat.	Single zone packaged <b>heat pumps</b>	<u>NonRes</u> : Packaged DX + VAV with electric <b>resistance</b> reheat <u>Res</u> : Single zone <b>heat pumps</b>
<b>Water Heating System</b>	Baseline	Electric <b>resistance</b> with storage	Electric <b>resistance</b> with storage	<u>NonRes</u> : <b>Electric</b> resistance storage <u>Res</u> : Central <b>gas</b> storage with recirculation
	Proposed All-Electric	Electric <b>resistance</b> with storage	Electric <b>resistance</b> with storage	<u>NonRes</u> : Electric <b>resistance</b> storage <u>Res</u> : Individual <b>heat pumps</b>

The Reach Code Team received cost data for baseline mixed-fuel equipment as well as electric equipment from an experienced mechanical contractor in the San Francisco Bay Area. The total construction cost includes equipment and material, labor, subcontractors (for example, HVAC and SHW control systems), and contractor overhead.

**3.3.1.1 Medium Office**

The baseline HVAC system includes two gas hot water boilers, three packaged rooftop units, and VAV hot water reheat boxes. The SHW design includes one 8.75 kW electric resistance hot water heater with a 30-gallon storage tank.

For the medium office all-electric HVAC design, the Reach Code Team investigated several potential all-electric design options, including variable refrigerant flow, packaged heat pumps, and variable volume and temperature systems. After seeking feedback from the design community, the Reach Code Team determined that the most feasible all-electric HVAC system, given the software modeling constraints is a VAV system with an electric resistance reheat instead of hot water reheat coil. A parallel fan-powered box (PFPB) implementation of electric resistance reheat would further improve efficiency due to reducing ventilation requirements, but an accurate implementation of PFPBs is not currently available in compliance software.

Note that the actual natural gas consumption for the VAV hot water reheat baseline may be higher than the current simulation results due to a combination of boiler and hot water distribution losses. A recent research study shows that the total losses can account for as high as 80 percent of the boiler energy use.<sup>19</sup>

---

<sup>19</sup> Raftery, P., A. Geronazzo, H. Cheng, and G. Paliaga. 2018. Quantifying energy losses in hot water reheat systems. Energy and Buildings, 179: 183-199. November. <https://doi.org/10.1016/j.enbuild.2018.09.020>. Retrieved from <https://escholarship.org/uc/item/3qs8f8qx>



If these losses are considered savings for the electric resistance reheat (which has zero associated distribution loss) may be higher.

The all-electric SHW system remains the same electric resistance water heater as the baseline and has no associated incremental costs.

Cost data for medium office designs are presented in Figure 10. The all-electric HVAC system presents cost savings compared to the hot water reheat system from elimination of the hot water boiler and associated hot water piping distribution. CZ10 and CZ15 all-electric design costs are slightly higher because they require larger size rooftop heat pumps than the other climate zones.

**Figure 10. Medium Office HVAC System Costs**

Climate Zone	Mixed Fuel Baseline	All Electric System	Incremental cost for All-Electric
<b>CZ01</b>	\$1,202,538	\$1,106,432	\$(96,106)
<b>CZ02</b>	\$1,261,531	\$1,178,983	\$(82,548)
<b>CZ03</b>	\$1,205,172	\$1,113,989	\$(91,183)
<b>CZ04</b>	\$1,283,300	\$1,205,434	\$(77,865)
<b>CZ05</b>	\$1,207,345	\$1,113,989	\$(93,356)
<b>CZ06</b>	\$1,216,377	\$1,131,371	\$(85,006)
<b>CZ07</b>	\$1,227,932	\$1,148,754	\$(79,178)
<b>CZ08</b>	\$1,250,564	\$1,172,937	\$(77,626)
<b>CZ09</b>	\$1,268,320	\$1,196,365	\$(71,955)
<b>CZ10</b>	\$1,313,580	\$1,256,825	\$(56,755)
<b>CZ11</b>	\$1,294,145	\$1,221,305	\$(72,840)
<b>CZ12</b>	\$1,274,317	\$1,197,121	\$(77,196)
<b>CZ13</b>	\$1,292,884	\$1,221,305	\$(71,579)
<b>CZ14</b>	\$1,286,245	\$1,212,236	\$(74,009)
<b>CZ15</b>	\$1,357,023	\$1,311,994	\$(45,029)
<b>CZ16</b>	\$1,295,766	\$1,222,817	\$(72,949)

### 3.3.1.2 Medium Retail

The baseline HVAC system includes five packaged single zone rooftop ACs with gas furnaces. Based on fan control requirements in section 140.4(m), units with cooling capacity  $\geq 65,000$  Btu/h have variable air volume fans, while smaller units have constant volume fans. The SHW design includes one 8.75 kW electric resistance hot water heater with a 30-gallon storage tank.

For the medium retail all-electric HVAC design, the Reach Code Team assumed packaged heat pumps instead of the packaged ACs. The all-electric SHW system remains the same electric resistance water heater as the baseline and has no associated incremental costs.

Cost data for medium retail designs are presented in Figure 11. Costs for rooftop air-conditioning systems are very similar to rooftop heat pump systems.



**Figure 11. Medium Retail HVAC System Costs**

Climate Zone	Mixed Fuel Baseline	All Electric System	Incremental cost for All-Electric
CZ01	\$328,312	\$333,291	\$4,978
CZ02	\$373,139	\$373,702	\$563
CZ03	\$322,849	\$326,764	\$3,915
CZ04	\$329,900	\$335,031	\$5,131
CZ05	\$359,888	\$362,408	\$2,520
CZ06	\$335,728	\$341,992	\$6,265
CZ07	\$345,544	\$349,808	\$4,265
CZ08	\$368,687	\$369,792	\$1,104
CZ09	\$415,155	\$411,069	\$(4,087)
CZ10	\$345,993	\$346,748	\$755
CZ11	\$418,721	\$414,546	\$(4,175)
CZ12	\$405,110	\$400,632	\$(4,477)
CZ13	\$376,003	\$375,872	\$(131)
CZ14	\$405,381	\$406,752	\$1,371
CZ15	\$429,123	\$427,606	\$(1,517)
CZ16	\$401,892	\$404,147	\$2,256

### 3.3.1.3 Small Hotel

The small hotel has two different baseline equipment systems, one for the nonresidential spaces and one for the guest rooms. The nonresidential HVAC system includes two gas hot water boilers, four packaged rooftop units and twelve VAV terminal boxes with hot water reheat coil. The SHW design includes a small electric water heater with storage tank. The residential HVAC design includes one single zone AC unit with gas furnace for each guest room and the water heating design includes one central gas storage water heater with a recirculation pump for all guest rooms.

For the small hotel all-electric design, the Reach Code Team assumed the nonresidential HVAC system to be packaged heat pumps with electric resistance VAV terminal units, and the SHW system to remain a small electric resistance water heater.

For the guest room all-electric HVAC system, the analysis used a single zone (packaged terminal) heat pump and a central heat pump water heater serving all guest rooms. Central heat pump water heating with recirculation serving guest rooms cannot yet be modeled in CBECC-Com, and energy impacts were modeled by simulating individual heat pump water heaters in each guest room. The reach code team believes this is a conservative assumption, since individual heat pump water heaters will have much higher tank standby losses. The Reach Code Team attained costs for central heat pump water heating installation including storage tanks and controls and used these costs in the study.

Cost data for small hotel designs are presented in Figure 12. The all-electric design presents substantial cost savings because there is no hot water plant or piping distribution system serving the nonresidential spaces, as well as the lower cost of packaged terminal heat pumps serving the residential spaces compared to split DX/furnace systems with individual flues.



**Figure 12. Small Hotel HVAC and Water Heating System Costs**

Climate Zone	Mixed Fuel Baseline	All Electric System	Incremental cost for All-Electric
CZ01	\$2,337,531	\$1,057,178	\$(1,280,353)
CZ02	\$2,328,121	\$1,046,795	\$(1,281,326)
CZ03	\$2,294,053	\$1,010,455	\$(1,283,598)
CZ04	\$2,302,108	\$1,018,675	\$(1,283,433)
CZ05	\$2,298,700	\$1,015,214	\$(1,283,486)
CZ06	\$2,295,380	\$1,011,753	\$(1,283,627)
CZ07	\$2,308,004	\$1,026,029	\$(1,281,975)
CZ08	\$2,333,662	\$1,053,717	\$(1,279,946)
CZ09	\$2,312,099	\$1,030,355	\$(1,281,744)
CZ10	\$2,354,093	\$1,075,348	\$(1,278,745)
CZ11	\$2,347,980	\$1,068,426	\$(1,279,554)
CZ12	\$2,328,654	\$1,047,660	\$(1,280,994)
CZ13	\$2,348,225	\$1,068,858	\$(1,279,367)
CZ14	\$2,345,988	\$1,066,263	\$(1,279,725)
CZ15	\$2,357,086	\$1,079,241	\$(1,277,845)
CZ16	\$2,304,094	\$1,019,973	\$(1,284,121)

### 3.3.2 *Infrastructure Impacts*

Electric heating appliances and equipment often require a larger electrical connection than an equivalent natural gas appliance because of the higher voltage and amperage necessary to electrically generate heat. Thus, many buildings may require larger electrical capacity than a comparable building with natural gas appliances. This includes:

- ◆ Electric resistance VAV space heating in the medium office and common area spaces of the small hotel.
- ◆ Heat pump water heating for the guest room spaces of the small hotel.

#### 3.3.2.1 *Electrical Panel Sizing and Wiring*

This section details the additional electrical panel sizing and wiring required for all-electric measures. In an all-electric new construction scenario, heat pumps replace packaged DX units which are paired with either a gas furnace or a hot water coil (supplied by a gas boiler). The electrical requirements of the replacement heat pump would be the same as the packaged DX unit it replaces, as the electrical requirements would be driven by the cooling capacity, which would remain the same between the two units.

VAV terminal units with hot water reheat coils that are replaced with electric resistance reheat coils require additional electrical infrastructure. In the case of electric resistance coils, the Reach Code Team assumed that on average, a VAV terminal unit serves around 900 ft<sup>2</sup> of conditioned space and has a heating capacity of 5 kW (15 kBtu/hr/ft<sup>2</sup>). The incremental electrical infrastructure costs were determined based on RS Means. Calculations for the medium office shown in Figure 13 include the cost to add electrical panels as well as the cost to add electrical lines to each VAV terminal unit electric resistance coil in the medium office prototype. Additionally, the Reach Code Team subtracted the electrical infrastructure costs associated with hot water pumps required in the mixed fuel baseline, which are not required in the all-electric measures.



The Reach Code Team calculated costs to increase electrical capacity for heat pump water heaters in the small hotel similarly.

**Figure 13. Medium Office Electrical Infrastructure Costs for All-Electric Design**

A	-	No. VAV Boxes	60
B	-	VAV box heating capacity (watts)	4,748
C	-	No. hot water pumps	2
D	-	Hot water pump power (watts)	398
E	-	Voltage	208
F	$(A \times B - C \times D) / E$	Panel ampacity required	1,366
G	$F / 400$	Number of 400-amp panels required	4
H	-	Cost per 400-amp panel	\$3,100
I	$G \times H$	Total panel cost	\$12,400
J	-	Total electrical line length required (ft)	4,320
K	-	Cost per linear foot of electrical line	\$3.62
L	$J \times K$	Total electrical line cost	\$15,402
	<b>I + L</b>	<b>Total electrical infrastructure incremental cost</b>	<b>\$27,802</b>

### 3.3.2.2 Natural Gas

This analysis assumes that in an all-electric new construction scenario natural gas would not be supplied to the site. Eliminating natural gas in new construction would save costs associated with connecting a service line from the street main to the building, piping distribution within the building, and monthly connection charges by the utility.

The Reach Code Team determined that for a new construction building with natural gas piping, there is a service line (branch connection) from the natural gas main to the building meter. In the medium office prototype, natural gas piping is routed to the boiler. The Reach Code Team assumed that the boiler is on the first floor, and that 30 feet of piping is required from the connection to the main to the boiler. The Reach Code Team assumed 1" corrugated stainless steel tubing (CSST) material is used for the plumbing distribution. The Reach Code Team included costs for a natural gas plan review, service extension, and a gas meter, as shown in Figure 14 below. The natural gas plan review cost is based on information received from the City of Palo Alto Utilities. The meter costs are from PG&E and include both material and labor. The service extension costs are based on guidance from PG&E, who noted that the cost range is highly varied and that there is no "typical" cost, with costs being highly dependent on length of extension, terrain, whether the building is in a developed or undeveloped area, and number of buildings to be served. While an actual service extension cost is highly uncertain, the team believes the costs assumed in this analysis are within a reasonable range based on a sample range of costs provided by PG&E. These costs assume development in a previously developed area.





**Figure 14. Natural Gas Infrastructure Cost Savings for All-Electric Prototypes**

Cost Type	Medium Office	Medium Retail	Small Hotel
Natural Gas Plan Review	\$2,316	\$2,316	\$2,316
Service Extension	\$13,000	\$13,000	\$13,000
Meter	\$3,000	\$3,000	\$3,000
Plumbing Distribution	\$633	\$9,711	\$37,704
<b>Total Cost</b>	<b>\$18,949</b>	<b>\$28,027</b>	<b>\$56,020</b>

### 3.4 Preempted High Efficiency Appliances

The Reach Code Team developed a package of high efficiency (HE) space and water heating appliances based on commonly available products for both the mixed-fuel and all-electric scenarios. This package assesses the standalone contribution that high efficiency measures would make toward achieving high performance thresholds. The Reach Code Team reviewed the Air Conditioning, Heating, and Refrigeration Institute (AHRI) certified product database to estimate appropriate efficiencies.<sup>20</sup>

The Reach Code Team determined the efficiency increases to be appropriate based on equipment type, summarized in Figure 15, with cost premiums attained from a Bay Area mechanical contractor. The ranges in efficiency are indicative of varying federal standard requirements based on equipment size.

**Figure 15. High Efficiency Appliance Assumptions**

	Federal Minimum Efficiency	Preempted Efficiency	Cost Premium for HE Appliance
Gas space heating and water heating	80-82%	90-95%	10-15%
Large packaged rooftop cooling	9.8-12 EER 11.4-12.9 IEER	10.5-13 EER 15-15.5 IEER	10-15%
Single zone heat pump space heating	7.7 HSPF 3.2 COP	10 HSPF 3.5 COP	6-15%
Heat pump water heating	2.0 UEF	3.3 UEF	None (market does not carry 2.0 UEF)

### 3.5 Greenhouse Gas Emissions

The analysis uses the greenhouse gas (GHG) emissions estimates from Zero Code reports available in CBECC-Com.<sup>21</sup> Zero Code uses 8760 hourly multipliers accounting for time dependent energy use and carbon emissions based on source emissions, including renewable portfolio standard projections. Fugitive

<sup>20</sup> Available at: <https://www.ahridirectory.org/Search/SearchHome?ReturnUrl=%2f>

<sup>21</sup> More information available at: <https://zero-code.org/wp-content/uploads/2018/11/ZERO-Code-TSD-California.pdf>



emissions are not included. There are two strings of multipliers – one for Northern California climate zones, and another for Southern California climate zones.<sup>22</sup>

## 4 Results

The Reach Code Team evaluated cost effectiveness of the following measure packages over a 2019 mixed-fuel code compliant baseline for all climate zones, as detailed in Sections 4.1 -- 4.3 and reiterated in Figure 16:

- ◆ **Package 1A – Mixed-Fuel + EE:** Mixed-fuel design with energy efficiency measures and federal minimum appliance efficiencies.
- ◆ **Package 1B – Mixed-Fuel + EE + PV + B:** Same as Package 1A, plus solar PV and batteries.
- ◆ **Package 1C – Mixed-fuel + HE:** Alternative design with high efficiency appliances, triggering federal preemption.
- ◆ **Package 2 – All-Electric Federal Code-Minimum Reference:** All-electric design with federal code minimum appliance efficiency. No solar PV or battery.
- ◆ **Package 3A – All-Electric + EE:** All-electric design with energy efficiency measures and federal minimum appliance efficiencies.
- ◆ **Package 3B – All-Electric + EE + PV + B:** Same as Package 3A, plus solar PV and batteries.
- ◆ **Package 3C – All-Electric + HE:** All-electric design with high efficiency appliances, triggering federal preemption.

**Figure 16. Package Summary**

Package	Fuel Type		Energy Efficiency Measures	PV & Battery (PV + B)	High Efficiency Appliances (HE)
	Mixed Fuel	All-Electric			
Mixed-Fuel Code Minimum Baseline	X				
1A – Mixed-Fuel + EE	X		X		
1B – Mixed-Fuel + EE + PV + B	X		X	X	
1C – Mixed-fuel + HE	X				X
2 – All-Electric Federal Code-Minimum Reference		X			
3A – All-Electric + EE		X	X		
3B – All-Electric + EE + PV + B		X	X	X	
3C – All-Electric + HE		X			X

<sup>22</sup> CBECC-Com documentation does not state which climate zones fall under which region. CBECC-Res multipliers are the same for CZs 1-5 and 11-13 (presumed to be Northern California), while there is another set of multipliers for CZs 6-10 and 14-16 (assumed to be Southern California).



Section 4.4 presents the results of the PV-only and PV+Battery analysis.

The TDV and on-bill based cost effectiveness results are presented in terms of B/C ratio and NPV in this section. What constitutes a ‘benefit’ or a ‘cost’ varies with the scenarios because both energy savings and incremental construction costs may be negative depending on the package. Typically, utility bill savings are categorized as a ‘benefit’ while incremental construction costs are treated as ‘costs.’ In cases where both construction costs are negative and utility bill savings are negative, the construction cost savings are treated as the ‘benefit’ while the utility bill negative savings are as the ‘cost.’

Overarching factors to keep in mind when reviewing the results include:

- ◆ To pass the Energy Commission’s application process, local reach codes must both be cost effective and exceed the energy performance budget using TDV (i.e., have a positive compliance margin). To emphasize these two important factors, the figures in this Section highlight in green the modeling results that have **either** a positive compliance margin or are cost effective. This will allow readers to identify whether a scenario is fully or partially supportive of a reach code, and the opportunities/challenges that the scenario presents. Conversely, Section 4.4 only highlights results that **both** have a positive compliance margin and are cost effective, to allow readers to identify reach code-ready scenarios.
- ◆ **Note:** Compliance margin represents the proportion of energy usage that is saved compared to the baseline, measured on a TDV basis.
- ◆ The Energy Commission does not currently allow compliance credit for either solar PV or battery storage. Thus, the compliance margins in Packages 1A are the same as 1B, and Package 3A is the same as 3B. However, The Reach Code Team did include the impact of solar PV and battery when calculating TDV cost-effectiveness.
- ◆ When performance modeling residential buildings, the Energy Commission allows the Standard Design to be electric if the Proposed Design is electric, which removes TDV-related penalties and associated negative compliance margins. This essentially allows for a compliance pathway for all-electric residential buildings. Nonresidential buildings are not treated in the same way and are compared to a mixed-fuel standard design.
- ◆ Results do not include an analysis and comparison of utility rates. As mentioned in *Section 2.2*, The Reach Code Team coordinated with utilities to select tariffs for each prototype given the annual energy demand profile and the most prevalent rates in each utility territory. The Reach Code Team did not compare a variety of tariffs to determine their impact on cost effectiveness. Note that most utility time-of-use rates are continuously updated, which can affect cost effectiveness results.
- ◆ As a point of comparison, mixed-fuel baseline energy figures are provided in *Appendix 6.5*.

#### **4.1 Cost Effectiveness Results – Medium Office**

Figure 17 through Figure 23 contain the cost-effectiveness findings for the Medium Office packages. Notable findings for each package include:

- ◆ **1A – Mixed-Fuel + EE:** Packages achieve +12 to +20 percent compliance margins depending on climate zone. All packages are cost effective in all climate zones using the TDV approach. All packages are cost effective using the On-Bill approach except for LADWP territory.



- ◆ **1B – Mixed-Fuel + EE + PV + B:** All packages are cost effective using the On-Bill and TDV approaches, except On-Bill in LADWP territory. When compared to 1A, the B/C ratio changes depending on the utility and climate zone (some increase while others decrease). However, NPV savings are increased across the board, suggesting that larger investments yield larger returns.
- ◆ **1C – Mixed-Fuel + HE:** Packages achieve +3 to +5 percent compliance margins depending on climate zone, but no packages were cost effective. The incremental costs of a high efficiency condensing boiler compared to a non-condensing boiler contributes to 26-47% of total incremental cost depending on boiler size. Benefits of condensing boiler efficiency come from resetting hot water return temperature as boiler efficiency increases at lower hot water temperature. However, hot water temperature reset control cannot currently be implemented in the software. In addition, the natural gas energy cost constitutes no more than 5% of total cost for 15 climate zones, so improving boiler efficiency has limited contribution to reduction of total energy cost.
- ◆ **2 – All-Electric Federal Code-Minimum Reference:**
  - ◆ Packages achieve between -27 percent and +1 percent compliance margins depending on climate zone. This is likely because the modeled system is electric resistance, and TDV values electricity consumption more heavily than natural gas. This all-electric design without other efficiency measures does not comply with the Energy Commission’s TDV performance budget.
  - ◆ All incremental costs are negative due to the elimination of natural gas infrastructure.
  - ◆ Packages achieve utility cost savings and are cost effective using the On-Bill approach in CZs 6-10 and 14-15. Packages do not achieve savings and are not cost effective using the On-Bill approach in most of PG&E territory (CZs 1,2,4, 11-13, and 16). Packages achieve savings and are cost effective using TDV in all climate zones except CZ16.
- ◆ **3A – All-Electric + EE:** Packages achieve positive compliance margins except -15 percent in CZ16, which has a higher space heating load than other climate zones. All packages are cost effective in all climate zones except CZ16.
- ◆ **3B – All-Electric + EE + PV + B:** Packages achieve positive compliance margins except -15 percent in CZ16. All packages are cost-effective from a TDV perspective in all climate zones. All packages are cost effective from an On-Bill perspective in all climate zones except in CZ 2 and CZ 16 in LADWP territory.
- ◆ **3C – All-Electric + HE:** Packages achieve between -26 percent and +2 percent compliance margins depending on climate zone. The only packages that are cost effective and with a positive compliance margin are in CZs 7-9 and 15. As described in Package 1C results, space heating is a relatively low proportion of energy costs in most climate zones, limiting the costs gains for higher efficiency equipment.



**Figure 17. Cost Effectiveness for Medium Office Package 1A – Mixed-Fuel + EE**

CZ	Utility	Elec Savings (kWh)	Gas Savings (therms)	GHG Reductions (mtons)	Compliance Margin	Incremental Package Cost	Lifecycle Utility Cost Savings	\$TDV Savings	B/C Ratio (On-bill)	B/C Ratio (TDV)	NPV (On-bill)	NPV (TDV)
<b>Package 1A: Mixed Fuel + EE</b>												
CZ01	PG&E	34,421	-808	4.5	18%	\$66,649	\$125,902	\$71,307	1.9	1.1	\$59,253	\$4,658
CZ02	PG&E	40,985	-505	8.1	17%	\$66,649	\$163,655	\$99,181	2.5	1.5	\$97,005	\$32,532
CZ03	PG&E	36,266	-463	7.0	20%	\$66,649	\$141,897	\$84,051	2.1	1.3	\$75,248	\$17,401
CZ04	PG&E	40,590	-547	7.7	14%	\$66,649	\$162,139	\$95,410	2.4	1.4	\$95,489	\$28,761
CZ04-2	CPAU	40,590	-547	7.7	14%	\$66,649	\$85,537	\$95,410	1.3	1.4	\$18,887	\$28,761
CZ05	PG&E	38,888	-499	7.4	18%	\$66,649	\$154,044	\$91,115	2.3	1.4	\$87,395	\$24,465
CZ05-2	SCG	38,888	-499	7.4	18%	\$66,649	\$156,315	\$91,115	2.3	1.4	\$89,665	\$24,465
CZ06	SCE	39,579	-305	8.7	20%	\$66,649	\$86,390	\$100,469	1.3	1.5	\$19,741	\$33,820
CZ06-2	LADWP	39,579	-305	8.7	20%	\$66,649	\$51,828	\$100,469	0.8	1.5	(\$14,821)	\$33,820
CZ07	SDG&E	41,817	-6	11.3	20%	\$66,649	\$204,394	\$112,497	3.1	1.7	\$137,745	\$45,848
CZ08	SCE	41,637	-60	10.8	18%	\$66,649	\$89,783	\$113,786	1.3	1.7	\$23,134	\$47,137
CZ08-2	LADWP	41,637	-60	10.8	18%	\$66,649	\$54,876	\$113,786	0.8	1.7	(\$11,773)	\$47,137
CZ09	SCE	42,539	-210	10.1	16%	\$66,649	\$95,636	\$115,647	1.4	1.7	\$28,987	\$48,998
CZ09-2	LADWP	42,539	-210	10.1	16%	\$66,649	\$58,168	\$115,647	0.9	1.7	(\$8,481)	\$48,998
CZ10	SDG&E	41,857	-216	9.8	17%	\$66,649	\$210,303	\$108,726	3.2	1.6	\$143,654	\$42,077
CZ10-2	SCE	41,857	-216	9.8	17%	\$66,649	\$92,736	\$108,726	1.4	1.6	\$26,087	\$42,077
CZ11	PG&E	42,523	-390	9.1	13%	\$66,649	\$166,951	\$104,001	2.5	1.6	\$100,301	\$37,352
CZ12	PG&E	41,521	-466	8.4	14%	\$66,649	\$161,594	\$100,135	2.4	1.5	\$94,945	\$33,486
CZ12-2	SMUD	41,521	-466	8.4	14%	\$66,649	\$71,734	\$100,135	1.1	1.5	\$5,085	\$33,486
CZ13	PG&E	42,898	-434	9.0	13%	\$66,649	\$169,107	\$99,992	2.5	1.5	\$102,457	\$33,343
CZ14	SDG&E	42,224	-441	8.6	14%	\$66,649	\$211,529	\$106,913	3.2	1.6	\$144,880	\$40,264
CZ14-2	SCE	42,224	-441	8.6	14%	\$66,649	\$95,809	\$106,913	1.4	1.6	\$29,160	\$40,264
CZ15	SCE	45,723	-147	11.2	12%	\$66,649	\$102,714	\$118,034	1.5	1.8	\$36,065	\$51,384
CZ16	PG&E	37,758	-736	5.8	14%	\$66,649	\$145,947	\$79,755	2.2	1.2	\$79,297	\$13,106
CZ16-2	LADWP	37,758	-736	5.8	14%	\$66,649	\$40,115	\$79,755	0.6	1.2	(\$26,534)	\$13,106



**Figure 18. Cost Effectiveness for Medium Office Package 1B – Mixed-Fuel + EE + PV + B**

CZ	Utility	Elec Savings (kWh)	Gas Savings (therms)	GHG savings (mtons)	Compliance Margin (%)	Incremental Package Cost	Lifecycle Energy Cost Savings	\$-TDV Savings	B/C Ratio (On-bill)	B/C Ratio (TDV)	NPV (On-bill)	NPV (TDV)
<b>Mixed Fuel + PV + Battery</b>												
CZ01	PG&E	211,225	-808	39.9	18%	\$397,405	\$645,010	\$454,284	1.6	1.1	\$247,605	\$56,879
CZ02	PG&E	255,787	-505	50.6	17%	\$397,405	\$819,307	\$573,033	2.1	1.4	\$421,902	\$175,628
CZ03	PG&E	245,421	-463	48.8	20%	\$397,405	\$777,156	\$536,330	2.0	1.3	\$379,751	\$138,925
CZ04	PG&E	267,612	-547	52.7	14%	\$397,405	\$836,221	\$597,471	2.1	1.5	\$438,816	\$200,066
CZ04-2	CPAU	267,612	-547	52.7	14%	\$397,405	\$621,879	\$597,471	1.6	1.5	\$224,474	\$200,066
CZ05	PG&E	264,581	-499	52.5	18%	\$397,405	\$897,216	\$578,856	2.3	1.5	\$499,811	\$181,451
CZ05-2	SCG	264,581	-499	52.5	18%	\$397,405	\$899,487	\$578,856	2.3	1.5	\$502,082	\$181,451
CZ06	SCE	257,474	-305	52.1	20%	\$397,405	\$484,229	\$594,416	1.2	1.5	\$86,824	\$197,011
CZ06-2	LA	257,474	-305	52.1	20%	\$397,405	\$282,360	\$594,416	0.7	1.5	(\$115,045)	\$197,011
CZ07	SDG&E	264,530	-6	55.7	20%	\$397,405	\$817,528	\$610,548	2.1	1.5	\$420,123	\$213,143
CZ08	SCE	258,348	-60	54.0	18%	\$397,405	\$479,073	\$625,249	1.2	1.6	\$81,668	\$227,844
CZ08-2	LA	258,348	-60	54.0	18%	\$397,405	\$275,704	\$625,249	0.7	1.6	(\$121,701)	\$227,844
CZ09	SCE	262,085	-210	54.3	16%	\$397,405	\$480,241	\$622,528	1.2	1.6	\$82,836	\$225,123
CZ09-2	LA	262,085	-210	54.3	16%	\$397,405	\$282,209	\$622,528	0.7	1.6	(\$115,196)	\$225,123
CZ10	SDG&E	258,548	-216	53.4	17%	\$397,405	\$839,931	\$595,323	2.1	1.5	\$442,526	\$197,918
CZ10-2	SCE	258,548	-216	53.4	17%	\$397,405	\$485,523	\$595,323	1.2	1.5	\$88,118	\$197,918
CZ11	PG&E	253,623	-390	50.9	13%	\$397,405	\$826,076	\$585,682	2.1	1.5	\$428,671	\$188,277
CZ12	PG&E	252,868	-466	50.3	14%	\$397,405	\$802,715	\$582,866	2.0	1.5	\$405,310	\$185,461
CZ12-2	SMUD	252,868	-466	50.3	14%	\$397,405	\$415,597	\$582,866	1.0	1.5	\$18,192	\$185,461
CZ13	PG&E	250,915	-434	50.4	13%	\$397,405	\$806,401	\$573,606	2.0	1.4	\$408,996	\$176,201
CZ14	SDG&E	283,684	-441	56.4	14%	\$397,405	\$874,753	\$676,271	2.2	1.7	\$477,348	\$278,866
CZ14-2	SCE	283,684	-441	56.4	14%	\$397,405	\$493,888	\$676,271	1.2	1.7	\$96,483	\$278,866
CZ15	SCE	274,771	-147	56.0	12%	\$397,405	\$476,327	\$640,379	1.2	1.6	\$78,922	\$242,974
CZ16	PG&E	266,490	-736	51.8	14%	\$397,405	\$842,205	\$575,563	2.1	1.4	\$444,800	\$178,158
CZ16-2	LA	266,490	-736	51.8	14%	\$397,405	\$260,372	\$575,563	0.7	1.4	(\$137,033)	\$178,158



**Figure 19. Cost Effectiveness for Medium Office Package 1C – Mixed-Fuel + HE**

CZ	Utility	Elec Savings (kWh)	Gas Savings (therms)	GHG Reductions (mtons)	Compliance Margin	Incremental Package Cost	Lifecycle Utility Cost Savings	\$TDV Savings	B/C Ratio (On-bill)	B/C Ratio (TDV)	NPV (On-bill)	NPV (TDV)
<b>Package 1C: Mixed Fuel + HE</b>												
CZ01	PG&E	288	688	4.1	3%	\$61,253	\$18,656	\$12,314	0.3	0.2	(\$42,597)	(\$48,939)
CZ02	PG&E	3,795	550	4.3	4%	\$68,937	\$36,683	\$24,676	0.5	0.4	(\$32,254)	(\$44,261)
CZ03	PG&E	1,241	439	2.9	3%	\$57,529	\$20,150	\$11,885	0.4	0.2	(\$37,379)	(\$45,644)
CZ04	PG&E	5,599	529	4.7	5%	\$72,074	\$44,915	\$30,928	0.6	0.4	(\$27,158)	(\$41,145)
CZ04-2	CPAU	5,599	529	4.7	5%	\$72,074	\$24,175	\$30,928	0.3	0.4	(\$47,898)	(\$41,145)
CZ05	PG&E	3,470	453	3.6	4%	\$60,330	\$35,072	\$18,232	0.6	0.3	(\$25,258)	(\$42,097)
CZ05-2	SCG	3,470	453	3.6	4%	\$60,330	\$32,777	\$18,232	0.5	0.3	(\$27,553)	(\$42,097)
CZ06	SCE	3,374	298	2.6	3%	\$55,594	\$19,446	\$16,132	0.3	0.3	(\$36,148)	(\$39,462)
CZ06-2	LADWP	3,374	298	2.6	3%	\$55,594	\$13,450	\$16,132	0.2	0.3	(\$42,145)	(\$39,462)
CZ07	SDG&E	5,257	140	2.3	4%	\$54,111	\$41,086	\$19,903	0.8	0.4	(\$13,025)	(\$34,208)
CZ08	SCE	5,921	176	2.7	4%	\$60,497	\$22,210	\$24,055	0.4	0.4	(\$38,287)	(\$36,442)
CZ08-2	LADWP	5,921	176	2.7	4%	\$60,497	\$14,064	\$24,055	0.2	0.4	(\$46,434)	(\$36,442)
CZ09	SCE	7,560	224	3.5	4%	\$61,311	\$28,576	\$31,835	0.5	0.5	(\$32,735)	(\$29,476)
CZ09-2	LADWP	7,560	224	3.5	4%	\$61,311	\$18,262	\$31,835	0.3	0.5	(\$43,049)	(\$29,476)
CZ10	SDG&E	5,786	288	3.2	4%	\$62,685	\$50,717	\$24,628	0.8	0.4	(\$11,968)	(\$38,057)
CZ10-2	SCE	5,786	288	3.2	4%	\$62,685	\$24,575	\$24,628	0.4	0.4	(\$38,110)	(\$38,057)
CZ11	PG&E	8,128	441	4.9	5%	\$71,101	\$54,188	\$37,849	0.8	0.5	(\$16,912)	(\$33,252)
CZ12	PG&E	6,503	478	4.7	5%	\$68,329	\$47,329	\$34,556	0.7	0.5	(\$20,999)	(\$33,773)
CZ12-2	SMUD	6,503	478	4.7	5%	\$68,329	\$24,003	\$34,556	0.4	0.5	(\$44,325)	(\$33,773)
CZ13	PG&E	8,398	432	5.0	5%	\$69,474	\$51,347	\$37,229	0.7	0.5	(\$18,128)	(\$32,246)
CZ14	SDG&E	7,927	470	5.0	5%	\$69,463	\$62,744	\$37,133	0.9	0.5	(\$6,718)	(\$32,329)
CZ14-2	SCE	7,927	470	5.0	5%	\$69,463	\$32,517	\$37,133	0.5	0.5	(\$36,946)	(\$32,329)
CZ15	SCE	15,140	219	5.5	5%	\$66,702	\$43,773	\$52,359	0.7	0.8	(\$22,929)	(\$14,344)
CZ16	PG&E	3,111	912	6.3	5%	\$71,765	\$36,002	\$24,914	0.5	0.3	(\$35,763)	(\$46,851)
CZ16-2	LADWP	3,111	912	6.3	5%	\$71,765	\$23,057	\$24,914	0.3	0.3	(\$48,708)	(\$46,851)



**Figure 20. Cost Effectiveness for Medium Office Package 2 – All-Electric Federal Code Minimum**

CZ	Utility	Elec Savings (kWh)	Gas Savings (therms)	GHG Reductions (mtons)	Compliance Margin	Incremental Package Cost*	Lifecycle Utility Cost Savings	\$TDV Savings	B/C Ratio (On-bill)	B/C Ratio (TDV)	NPV (On-bill)	NPV (TDV)
<b>Package 2: All-Electric Federal Code Minimum</b>												
CZ01	PG&E	-53,657	4967	10.1	-15%	(\$87,253)	(\$98,237)	(\$58,420)	0.9	1.5	(\$10,984)	\$28,833
CZ02	PG&E	-49,684	3868	5.0	-7%	(\$73,695)	(\$101,605)	(\$41,429)	0.7	1.8	(\$27,910)	\$32,266
CZ03	PG&E	-35,886	3142	5.6	-7%	(\$82,330)	(\$57,345)	(\$29,592)	1.4	2.8	\$24,986	\$52,738
CZ04	PG&E	-48,829	3759	4.7	-6%	(\$69,012)	(\$90,527)	(\$40,570)	0.8	1.7	(\$21,515)	\$28,443
CZ04-2	CPAU	-48,829	3759	4.7	-6%	(\$69,012)	(\$19,995)	(\$40,570)	3.5	1.7	\$49,018	\$28,443
CZ05	PG&E	-40,531	3240	4.5	-8%	(\$84,503)	(\$63,663)	(\$39,997)	1.3	2.1	\$20,840	\$44,506
CZ06	SCE	-26,174	2117	3.1	-4%	(\$76,153)	\$24,908	(\$20,571)	>1	3.7	\$101,061	\$55,581
CZ06-2	LADWP	-26,174	2117	3.1	-4%	(\$76,153)	\$26,366	(\$20,571)	>1	3.7	\$102,518	\$55,581
CZ07	SDG&E	-12,902	950	0.9	-2%	(\$70,325)	\$46,879	(\$11,407)	>1	6.2	\$117,204	\$58,918
CZ08	SCE	-15,680	1219	1.5	-2%	(\$68,774)	\$17,859	(\$12,648)	>1	5.4	\$86,633	\$56,125
CZ08-2	LADWP	-15,680	1219	1.5	-2%	(\$68,774)	\$18,603	(\$12,648)	>1	5.4	\$87,376	\$56,125
CZ09	SCE	-19,767	1605	2.4	-2%	(\$63,102)	\$20,920	(\$14,462)	>1	4.4	\$84,022	\$48,640
CZ09-2	LADWP	-19,767	1605	2.4	-2%	(\$63,102)	\$21,929	(\$14,462)	>1	4.4	\$85,030	\$48,640
CZ10	SDG&E	-27,414	2053	2.2	-4%	(\$47,902)	\$38,918	(\$23,339)	>1	2.1	\$86,820	\$24,562
CZ10-2	SCE	-27,414	2053	2.2	-4%	(\$47,902)	\$20,765	(\$23,339)	>1	2.1	\$68,666	\$24,562
CZ11	PG&E	-40,156	3062	3.6	-4%	(\$63,987)	(\$72,791)	(\$32,837)	0.9	1.9	(\$8,804)	\$31,150
CZ12	PG&E	-43,411	3327	4.1	-5%	(\$68,343)	(\$85,856)	(\$35,463)	0.8	1.9	(\$17,512)	\$32,880
CZ12-2	SMUD	-43,411	3327	4.1	-5%	(\$68,343)	(\$5,109)	(\$35,463)	13.4	1.9	\$63,234	\$32,880
CZ13	PG&E	-39,649	3063	3.8	-4%	(\$62,726)	(\$70,705)	(\$32,408)	0.9	1.9	(\$7,980)	\$30,318
CZ14	SDG&E	-44,322	3266	3.4	-5%	(\$65,156)	\$6,043	(\$38,422)	>1	1.7	\$71,199	\$26,735
CZ14-2	SCE	-44,322	3266	3.4	-5%	(\$65,156)	\$4,798	(\$38,422)	>1	1.7	\$69,954	\$26,735
CZ15	SCE	-19,917	1537	1.8	-2%	(\$36,176)	\$12,822	(\$15,464)	>1	2.3	\$48,998	\$20,711
CZ16	PG&E	-94,062	6185	5.6	-27%	(\$64,096)	(\$212,158)	(\$150,871)	0.3	0.4	(\$148,062)	(\$86,775)
CZ16-2	LADWP	-94,062	6185	5.6	-27%	(\$64,096)	\$1,493	(\$150,871)	>1	0.4	\$65,589	(\$86,775)

\*The Incremental Package Cost is equal to the sum of the incremental HVAC and water heating equipment costs from

Figure 10, the electrical infrastructure incremental cost of \$27,802 (see section 3.3.2.1), and the natural gas infrastructure incremental costs of \$(18,949) (see section 3.3.2.2).





**Figure 21. Cost Effectiveness for Medium Office Package 3A – All-Electric + EE**

CZ	Utility	Elec Savings (kWh)	Gas Savings (therms)	GHG Reductions (mtons)	Compliance Margin	Incremental Package Cost	Lifecycle Utility Cost Savings	\$TDV Savings	B/C Ratio (On-bill)	B/C Ratio (TDV)	NPV (On-bill)	NPV (TDV)
<b>Package 3A: All-Electric + EE</b>												
CZ01	PG&E	-19,115	4967	19.4	7%	(\$20,604)	\$20,630	\$28,112	>1	>1	\$41,234	\$48,716
CZ02	PG&E	-11,811	3868	15.2	10%	(\$7,046)	\$39,260	\$58,563	>1	>1	\$46,306	\$65,609
CZ03	PG&E	2,530	3142	16.2	16%	(\$15,681)	\$85,241	\$68,682	>1	>1	\$100,922	\$84,363
CZ04	PG&E	-10,839	3759	14.8	9%	(\$2,363)	\$59,432	\$58,420	>1	>1	\$61,795	\$60,783
CZ04-2	CPAU	-10,839	3759	14.8	9%	(\$2,363)	\$70,680	\$58,420	>1	>1	\$73,043	\$60,783
CZ05	PG&E	-2,316	3240	14.6	12%	(\$17,854)	\$85,380	\$58,802	>1	>1	\$103,234	\$76,656
CZ06	SCE	15,399	2117	14.3	18%	(\$9,503)	\$114,962	\$89,921	>1	>1	\$124,466	\$99,425
CZ06-2	LADWP	15,399	2117	14.3	18%	(\$9,503)	\$82,389	\$89,921	>1	>1	\$91,893	\$99,425
CZ07	SDG&E	33,318	950	13.8	20%	(\$3,676)	\$256,704	\$111,399	>1	>1	\$260,380	\$115,076
CZ08	SCE	30,231	1219	14.2	18%	(\$2,124)	\$110,144	\$111,781	>1	>1	\$112,268	\$113,906
CZ08-2	LADWP	30,231	1219	14.2	18%	(\$2,124)	\$76,069	\$111,781	>1	>1	\$78,194	\$113,906
CZ09	SCE	24,283	1605	14.3	15%	\$3,547	\$119,824	\$108,249	33.8	30.5	\$116,277	\$104,702
CZ09-2	LADWP	24,283	1605	14.3	15%	\$3,547	\$83,549	\$108,249	23.6	30.5	\$80,001	\$104,702
CZ10	SDG&E	12,344	2053	12.6	13%	\$18,748	\$230,553	\$82,905	12.3	4.4	\$211,806	\$64,158
CZ10-2	SCE	12,344	2053	12.6	13%	\$18,748	\$105,898	\$82,905	5.6	4.4	\$87,150	\$64,158
CZ11	PG&E	929	3062	14.5	10%	\$2,662	\$85,988	\$75,030	32.3	28.2	\$83,326	\$72,368
CZ12	PG&E	-3,419	3327	14.8	10%	(\$1,694)	\$68,866	\$69,589	>1	>1	\$70,560	\$71,283
CZ12-2	SMUD	-3,419	3327	14.8	10%	(\$1,694)	\$71,761	\$69,589	>1	>1	\$73,455	\$71,283
CZ13	PG&E	1,398	3063	14.8	9%	\$3,923	\$89,799	\$71,307	22.9	18.2	\$85,875	\$67,384
CZ14	SDG&E	-5,469	3266	13.5	9%	\$1,493	\$206,840	\$69,016	138.6	46.2	\$205,347	\$67,523
CZ14-2	SCE	-5,469	3266	13.5	9%	\$1,493	\$94,143	\$69,016	63.1	46.2	\$92,650	\$67,523
CZ15	SCE	25,375	1537	13.7	10%	\$30,474	\$114,909	\$104,335	3.8	3.4	\$84,435	\$73,862
CZ16	PG&E	-65,877	6185	12.7	-15%	\$2,553	(\$91,477)	(\$85,673)	-35.8	-33.6	(\$94,030)	(\$88,226)
CZ16-2	LADWP	-65,877	6185	12.7	-15%	\$2,553	\$72,780	(\$85,673)	28.5	-33.6	\$70,227	(\$88,226)



**Figure 22. Cost Effectiveness for Medium Office Package 3B – All-Electric + EE + PV + B**

CZ	IOU territory	Elec Savings (kWh)	Gas Savings (therms)	GHG savings (mtons)	Compliance Margin (%)	Incremental Package Cost	Lifecycle Energy Cost Savings	-\$TDV Savings	B/C Ratio (On-bill)	B/C Ratio (TDV)	NPV (On-bill)	NPV (TDV)
<b>All-Electric + PV + B</b>												
CZ01	PG&E	157,733	4967	54.9	7%	\$310,152	\$518,421	\$410,946	1.7	1.3	\$208,269	\$100,794
CZ02	PG&E	203,026	3868	57.8	10%	\$323,710	\$692,336	\$532,273	2.1	1.6	\$368,626	\$208,563
CZ03	PG&E	211,706	3142	58.0	16%	\$315,075	\$708,235	\$520,866	2.2	1.7	\$393,160	\$205,791
CZ04	PG&E	216,204	3759	59.9	9%	\$328,393	\$741,382	\$560,576	2.3	1.7	\$412,989	\$232,183
CZ04-2	CPAU	216,204	3759	59.9	9%	\$328,393	\$607,074	\$560,576	1.8	1.7	\$278,681	\$232,183
CZ05	PG&E	223,399	3240	59.8	12%	\$312,902	\$799,992	\$546,592	2.6	1.7	\$487,090	\$233,690
CZ06	SCE	233,299	2117	57.7	18%	\$321,252	\$509,969	\$583,963	1.6	1.8	\$188,716	\$262,711
CZ06-2	LA	233,299	2117	57.7	18%	\$321,252	\$311,931	\$583,963	1.0	1.8	(\$9,322)	\$262,711
CZ07	SDG&E	256,034	950	58.3	20%	\$327,079	\$870,156	\$609,498	2.7	1.9	\$543,076	\$282,419
CZ08	SCE	246,944	1219	57.4	18%	\$328,631	\$499,506	\$623,292	1.5	1.9	\$170,874	\$294,661
CZ08-2	LA	246,944	1219	57.4	18%	\$328,631	\$296,991	\$623,292	0.9	1.9	(\$31,640)	\$294,661
CZ09	SCE	243,838	1605	58.5	15%	\$334,303	\$504,498	\$615,178	1.5	1.8	\$170,195	\$280,875
CZ09-2	LA	243,838	1605	58.5	15%	\$334,303	\$307,626	\$615,178	0.9	1.8	(\$26,677)	\$280,875
CZ10	SDG&E	229,044	2053	56.2	13%	\$349,503	\$851,810	\$569,549	2.4	1.6	\$502,306	\$220,046
CZ10-2	SCE	229,044	2053	56.2	13%	\$349,503	\$491,383	\$569,549	1.4	1.6	\$141,880	\$220,046
CZ11	PG&E	212,047	3062	56.4	10%	\$333,418	\$743,403	\$556,758	2.2	1.7	\$409,985	\$223,340
CZ12	PG&E	207,955	3327	56.7	10%	\$329,062	\$713,054	\$552,415	2.2	1.7	\$383,993	\$223,353
CZ12-2	SMUD	207,955	3327	56.7	10%	\$329,062	\$414,371	\$552,415	1.3	1.7	\$85,310	\$223,353
CZ13	PG&E	209,431	3063	56.3	9%	\$334,679	\$728,822	\$544,969	2.2	1.6	\$394,143	\$210,289
CZ14	SDG&E	236,002	3266	61.3	9%	\$332,249	\$865,181	\$638,517	2.6	1.9	\$532,933	\$306,269
CZ14-2	SCE	236,002	3266	61.3	9%	\$332,249	\$488,163	\$638,517	1.5	1.9	\$155,914	\$306,269
CZ15	SCE	254,426	1537	58.5	10%	\$361,229	\$487,715	\$626,728	1.4	1.7	\$126,486	\$265,499
CZ16	PG&E	162,915	6185	58.6	-15%	\$333,309	\$580,353	\$406,746	1.7	1.2	\$247,044	\$73,437
CZ16-2	LA	162,915	6185	58.6	-15%	\$333,309	\$290,566	\$406,746	0.9	1.2	(\$42,742)	\$73,437



**Figure 23. Cost Effectiveness for Medium Office Package 3C – All-Electric + HE**

CZ	Utility	Elec Savings (kWh)	Gas Savings (therms)	GHG Reductions (mtons)	Compliance Margin	Incremental Package Cost	Lifecycle Utility Cost Savings	\$TDV Savings	B/C Ratio (On-bill)	B/C Ratio (TDV)	NPV (On-bill)	NPV (TDV)
<b>Package 3C: All-Electric + HE</b>												
CZ01	PG&E	-53,390	4967	10.2	-14%	(\$43,987)	(\$93,740)	(\$57,752)	0.5	0.8	(\$49,753)	(\$13,765)
CZ02	PG&E	-45,916	3868	6.1	-5%	(\$22,722)	(\$77,212)	(\$26,394)	0.3	0.9	(\$54,490)	(\$3,672)
CZ03	PG&E	-34,656	3142	6.0	-6%	(\$38,261)	(\$45,796)	(\$25,153)	0.8	1.5	(\$7,535)	\$13,108
CZ04	PG&E	-43,248	3759	6.3	-3%	(\$15,229)	(\$56,932)	(\$18,996)	0.3	0.8	(\$41,703)	(\$3,767)
CZ04-2	CPAU	-43,248	3759	6.3	-3%	(\$15,229)	(\$5,298)	(\$18,996)	2.9	0.8	\$9,932	(\$3,767)
CZ05	PG&E	-37,068	3240	5.4	-6%	(\$40,434)	(\$38,330)	(\$29,544)	1.1	1.4	\$2,104	\$10,890
CZ06	SCE	-22,805	2117	4.0	-2%	(\$30,237)	\$39,812	(\$9,594)	>1	3.2	\$70,050	\$20,644
CZ06-2	LADWP	-22,805	2117	4.0	-2%	(\$30,237)	\$35,414	(\$9,594)	>1	3.2	\$65,651	\$20,644
CZ07	SDG&E	-7,646	950	2.5	1%	(\$22,564)	\$86,159	\$6,062	>1	>1	\$108,722	\$28,625
CZ08	SCE	-9,761	1219	3.2	1%	(\$18,443)	\$37,375	\$8,305	>1	>1	\$55,818	\$26,748
CZ08-2	LADWP	-9,761	1219	3.2	1%	(\$18,443)	\$29,973	\$8,305	>1	>1	\$48,416	\$26,748
CZ09	SCE	-12,211	1605	4.5	2%	(\$10,282)	\$46,335	\$13,364	>1	>1	\$56,617	\$23,646
CZ09-2	LADWP	-12,211	1605	4.5	2%	(\$10,282)	\$37,030	\$13,364	>1	>1	\$47,313	\$23,646
CZ10	SDG&E	-21,642	2053	3.7	-1%	\$11,340	\$84,901	(\$3,818)	7.5	-0.3	\$73,561	(\$15,158)
CZ10-2	SCE	-21,642	2053	3.7	-1%	\$11,340	\$40,659	(\$3,818)	3.6	-0.3	\$29,319	(\$15,158)
CZ11	PG&E	-32,052	3062	5.9	0%	(\$8,519)	(\$29,013)	(\$3,007)	0.3	2.8	(\$20,495)	\$5,512
CZ12	PG&E	-36,926	3327	6.0	-1%	(\$15,443)	(\$48,955)	(\$9,546)	0.3	1.6	(\$33,511)	\$5,898
CZ12-2	SMUD	-36,926	3327	6.0	-1%	(\$15,443)	\$9,916	(\$9,546)	>1	1.6	\$25,359	\$5,898
CZ13	PG&E	-31,253	3063	6.3	0%	(\$7,257)	(\$27,782)	(\$3,055)	0.3	2.4	(\$20,525)	\$4,202
CZ14	SDG&E	-36,402	3266	5.7	-1%	(\$10,651)	\$61,605	(\$9,832)	>1	1.1	\$72,256	\$819
CZ14-2	SCE	-36,402	3266	5.7	-1%	(\$10,651)	\$30,625	(\$9,832)	>1	1.1	\$41,276	\$819
CZ15	SCE	-4,775	1537	6.0	3%	\$28,927	\$52,955	\$32,790	1.8	1.1	\$24,028	\$3,863
CZ16	PG&E	-90,949	6185	6.5	-26%	(\$8,467)	(\$194,115)	(\$142,041)	0.0	0.1	(\$185,648)	(\$133,574)
CZ16-2	LADWP	-90,949	6185	6.5	-26%	(\$8,467)	\$37,127	(\$142,041)	>1	0.1	\$45,594	(\$133,574)



## 4.2 Cost Effectiveness Results – Medium Retail

Figure 24 through Figure 30 contain the cost-effectiveness findings for the Medium Retail packages. Notable findings for each package include:

- ◆ **1A – Mixed-Fuel + EE:**
  - ◆ Packages achieve +9% to +18% compliance margins depending on climate zone, and all packages are cost effective in all climate zones.
  - ◆ Incremental package costs vary across climate zones because of the HVAC system size in some climate zones are small enough (<54 kBtu/h) to have the economizers measure applied.
  - ◆ B/C ratios are high compared to other prototypes because the measures applied are primarily low-cost lighting measures. This suggests room for the inclusion of other energy efficiency measures with lower cost-effectiveness to achieve even higher compliance margins for a cost effective package.
- ◆ **1B – Mixed-Fuel + EE + PV + B:** All packages are cost effective using both the On-Bill and TDV approach, except On-Bill in LADWP territory. Adding PV and battery to the efficiency packages reduces the B/C ratio but increases overall NPV savings.
- ◆ **1C – Mixed-fuel + HE:** Packages achieve +1 to +4% compliance margins depending on climate zone, and packages are cost effective in all climate zones except CZs 1, 3 and 5 using the TDV approach.
- ◆ **2 – All-Electric Federal Code-Minimum Reference:**
  - ◆ Packages achieve between -12% and +1% compliance margins depending on climate zone.
  - ◆ Packages achieve positive savings using both the On-Bill and TDV approaches in CZs 6-10 and 14-15. Packages do not achieve On-Bill or TDV savings in most of PG&E territory (CZs 1, 2, 4, 5, 12-13, and 16).
  - ◆ Packages are cost effective in all climate zones except CZ16.
  - ◆ All incremental costs are negative primarily due to elimination of natural gas infrastructure.
- ◆ **3A – All-Electric + EE:** Packages achieve between +3% and +16% compliance margins depending on climate zone. All packages are cost effective in all climate zones.
- ◆ **3B – All-Electric + EE + PV + B:** All packages are cost effective using both the On-Bill and TDV approaches, except On-Bill in LADWP territory. Adding PV and Battery to the efficiency package reduces the B/C ratio but increases overall NPV savings.
- ◆ **3C – All-Electric + HE:** Packages achieve between -8% and +5% compliance margins depending on climate zone, and packages are cost effective using both On-Bill and TDV approaches in all CZs except CZs 1 and 16.



**Figure 24. Cost Effectiveness for Medium Retail Package 1A – Mixed-Fuel + EE**

CZ	Utility	Elec Savings (kWh)	Gas Savings (therms)	GHG Reductions (mtons)	Compliance Margin	Incremental Package Cost	Lifecycle Utility Cost Savings	\$TDV Savings	B/C Ratio (On-bill)	B/C Ratio (TDV)	NPV (On-bill)	NPV (TDV)
<b>Package 1A: Mixed Fuel + EE</b>												
CZ01	PG&E	15,210	1209	11.10	18%	\$2,712	\$68,358	\$60,189	25.2	22.2	\$65,646	\$57,478
CZ02	PG&E	18,885	613	8.73	13%	\$5,569	\$76,260	\$59,135	13.7	10.6	\$70,691	\$53,566
CZ03	PG&E	18,772	462	7.87	16%	\$5,569	\$66,813	\$57,135	12.0	10.3	\$61,244	\$51,566
CZ04	PG&E	19,100	439	7.84	14%	\$5,569	\$75,989	\$58,036	13.6	10.4	\$70,420	\$52,467
CZ04-2	CPAU	19,100	439	7.84	14%	\$5,569	\$51,556	\$58,036	9.3	10.4	\$45,987	\$52,467
CZ05	PG&E	17,955	415	7.41	16%	\$5,569	\$63,182	\$55,003	11.3	9.9	\$57,613	\$49,435
CZ05-2	SCG	17,955	415	7.41	16%	\$5,569	\$61,810	\$55,003	11.1	9.9	\$56,241	\$49,435
CZ06	SCE	12,375	347	5.54	10%	\$2,712	\$31,990	\$41,401	11.8	15.3	\$29,278	\$38,689
CZ06-2	LADWP	12,375	347	5.54	10%	\$2,712	\$21,667	\$41,401	8.0	15.3	\$18,956	\$38,689
CZ07	SDG&E	17,170	136	5.65	13%	\$5,569	\$73,479	\$49,883	13.2	9.0	\$67,910	\$44,314
CZ08	SCE	12,284	283	5.15	10%	\$2,712	\$30,130	\$41,115	11.1	15.2	\$27,419	\$38,403
CZ08-2	LADWP	12,284	283	5.15	10%	\$2,712	\$20,243	\$41,115	7.5	15.2	\$17,531	\$38,403
CZ09	SCE	13,473	302	5.51	10%	\$5,569	\$32,663	\$46,126	5.9	8.3	\$27,094	\$40,557
CZ09-2	LADWP	13,473	302	5.51	10%	\$5,569	\$22,435	\$46,126	4.0	8.3	\$16,866	\$40,557
CZ10	SDG&E	19,873	267	6.99	12%	\$5,569	\$83,319	\$58,322	15.0	10.5	\$77,751	\$52,753
CZ10-2	SCE	19,873	267	6.99	12%	\$5,569	\$39,917	\$58,322	7.2	10.5	\$34,348	\$52,753
CZ11	PG&E	21,120	578	9.14	13%	\$5,569	\$86,663	\$67,485	15.6	12.1	\$81,095	\$61,916
CZ12	PG&E	20,370	562	8.85	13%	\$5,569	\$81,028	\$64,409	14.6	11.6	\$75,459	\$58,840
CZ12-2	SMUD	20,370	562	8.85	13%	\$5,569	\$44,991	\$64,409	8.1	11.6	\$39,422	\$58,840
CZ13	PG&E	22,115	620	9.98	15%	\$2,712	\$109,484	\$83,109	40.4	30.6	\$106,772	\$80,398
CZ14	SDG&E	25,579	406	9.38	13%	\$2,712	\$116,354	\$80,055	42.9	29.5	\$113,643	\$77,343
CZ14-2	SCE	26,327	383	9.42	13%	\$2,712	\$57,290	\$83,065	21.1	30.6	\$54,578	\$80,354
CZ15	SCE	26,433	169	8.35	12%	\$2,712	\$57,152	\$79,506	21.1	29.3	\$54,440	\$76,794
CZ16	PG&E	15,975	752	8.72	13%	\$2,712	\$72,427	\$55,025	26.7	20.3	\$69,715	\$52,314
CZ16-2	LADWP	15,975	752	8.72	13%	\$2,712	\$31,906	\$55,025	11.8	20.3	\$29,194	\$52,314



**Figure 25. Cost Effectiveness for Medium Retail Package 1B – Mixed-Fuel + EE + PV + B**

CZ	IOU territory	Elec Savings (kWh)	Gas Savings (therms)	GHG savings (tons)	Compliance Margin (%)	Incremental Package Cost	Lifecycle Energy Cost Savings	-\$TDV Savings	B/C Ratio (On-bill)	B/C Ratio (TDV)	NPV (On-bill)	NPV (TDV)
<b>Mixed Fuel + PV + Battery</b>												
CZ01	PG&E	158,584	1209	40.79	18%	\$277,383	\$509,092	\$383,683	1.8	1.4	\$231,709	\$106,300
CZ02	PG&E	189,400	613	43.75	13%	\$280,240	\$590,043	\$465,474	2.1	1.7	\$309,803	\$185,234
CZ03	PG&E	191,016	462	43.52	16%	\$280,240	\$578,465	\$452,795	2.1	1.6	\$298,224	\$172,554
CZ04	PG&E	195,014	439	44.14	14%	\$280,240	\$605,369	\$480,989	2.2	1.7	\$325,129	\$200,748
CZ04-2	CPAU	195,014	439	44.14	14%	\$280,240	\$451,933	\$480,989	1.6	1.7	\$171,693	\$200,748
CZ05	PG&E	196,654	415	44.30	16%	\$280,240	\$589,771	\$464,749	2.1	1.7	\$309,530	\$184,509
CZ05-2	SCG	196,654	415	44.30	16%	\$280,240	\$588,407	\$464,749	2.1	1.7	\$308,167	\$184,509
CZ06	SCE	185,903	347	41.61	10%	\$277,383	\$322,495	\$456,596	1.2	1.6	\$45,111	\$179,213
CZ06-2	LA	185,903	347	41.61	10%	\$277,383	\$191,428	\$456,596	0.7	1.6	(\$85,955)	\$179,213
CZ07	SDG&E	197,650	136	43.24	13%	\$280,240	\$496,786	\$477,582	1.8	1.7	\$216,545	\$197,342
CZ08	SCE	187,869	283	41.48	10%	\$277,383	\$326,810	\$478,132	1.2	1.7	\$49,427	\$200,749
CZ08-2	LA	187,869	283	41.48	10%	\$277,383	\$190,379	\$478,132	0.7	1.7	(\$87,004)	\$200,749
CZ09	SCE	191,399	302	42.32	10%	\$280,240	\$334,869	\$472,770	1.2	1.7	\$54,629	\$192,530
CZ09-2	LA	191,399	302	42.32	10%	\$280,240	\$201,759	\$472,770	0.7	1.7	(\$78,481)	\$192,530
CZ10	SDG&E	200,033	267	44.01	12%	\$280,240	\$547,741	\$472,880	2.0	1.7	\$267,501	\$192,640
CZ10-2	SCE	200,033	267	44.01	12%	\$280,240	\$340,822	\$472,880	1.2	1.7	\$60,582	\$192,640
CZ11	PG&E	192,846	578	44.07	13%	\$280,240	\$582,969	\$490,855	2.1	1.8	\$302,728	\$210,615
CZ12	PG&E	191,720	562	43.70	13%	\$280,240	\$586,836	\$485,076	2.1	1.7	\$306,596	\$204,836
CZ12-2	SMUD	191,720	562	43.70	13%	\$280,240	\$319,513	\$485,076	1.1	1.7	\$39,273	\$204,836
CZ13	PG&E	195,031	620	45.19	15%	\$277,383	\$605,608	\$486,285	2.2	1.8	\$328,225	\$208,901
CZ14	SDG&E	217,183	406	47.86	13%	\$277,383	\$559,148	\$534,915	2.0	1.9	\$281,765	\$257,532
CZ14-2	SCE	217,927	383	47.91	14%	\$277,383	\$354,757	\$538,058	1.3	1.9	\$77,373	\$260,674
CZ15	SCE	208,662	169	44.51	12%	\$277,383	\$338,772	\$496,107	1.2	1.8	\$61,389	\$218,724
CZ16	PG&E	210,242	752	48.76	13%	\$277,383	\$608,779	\$490,262	2.2	1.8	\$331,395	\$212,879
CZ16-2	LA	210,242	752	48.76	13%	\$277,383	\$207,160	\$490,262	0.7	1.8	(\$70,223)	\$212,879



**Figure 26. Cost Effectiveness for Medium Retail Package 1C – Mixed-Fuel + HE**

CZ	Utility	Elec Savings (kWh)	Gas Savings (therms)	GHG Reductions (mtons)	Compliance Margin	Incremental Package Cost	Lifecycle Utility Cost Savings	\$TDV Savings	B/C Ratio (On-bill)	B/C Ratio (TDV)	NPV (On-bill)	NPV (TDV)
<b>Package 1C: Mixed Fuel + HE</b>												
CZ01	PG&E	57	346	2.04	2%	\$9,006	\$6,301	\$6,065	0.7	0.7	(\$2,705)	(\$2,941)
CZ02	PG&E	2,288	229	2.01	3%	\$9,726	\$23,016	\$13,998	2.4	1.4	\$13,291	\$4,273
CZ03	PG&E	1,087	171	1.31	2%	\$9,063	\$6,782	\$7,186	0.7	0.8	(\$2,282)	(\$1,877)
CZ04	PG&E	1,862	159	1.46	3%	\$9,004	\$17,891	\$10,878	2.0	1.2	\$8,887	\$1,874
CZ04-2	CPAU	1,862	159	1.46	3%	\$9,004	\$7,821	\$10,878	0.9	1.2	(\$1,182)	\$1,874
CZ05	PG&E	664	162	1.11	1%	\$9,454	\$5,119	\$4,725	0.5	0.5	(\$4,335)	(\$4,729)
CZ05-2	SCG	664	162	1.11	1%	\$9,454	\$4,558	\$4,725	0.5	0.5	(\$4,896)	(\$4,729)
CZ06	SCE	2,648	90	1.24	3%	\$8,943	\$11,646	\$11,427	1.3	1.3	\$2,703	\$2,484
CZ06-2	LADWP	2,648	90	1.24	3%	\$8,943	\$7,329	\$11,427	0.8	1.3	(\$1,614)	\$2,484
CZ07	SDG&E	2,376	49	0.95	2%	\$9,194	\$20,103	\$9,779	2.2	1.1	\$10,909	\$585
CZ08	SCE	2,822	72	1.20	3%	\$9,645	\$11,989	\$12,877	1.2	1.3	\$2,344	\$3,233
CZ08-2	LADWP	2,822	72	1.20	3%	\$9,645	\$7,427	\$12,877	0.8	1.3	(\$2,218)	\$3,233
CZ09	SCE	4,206	88	1.73	4%	\$10,446	\$16,856	\$18,745	1.6	1.8	\$6,410	\$8,299
CZ09-2	LADWP	4,206	88	1.73	4%	\$10,446	\$10,604	\$18,745	1.0	1.8	\$158	\$8,299
CZ10	SDG&E	4,226	119	1.88	4%	\$9,514	\$36,412	\$19,008	3.8	2.0	\$26,898	\$9,494
CZ10-2	SCE	4,226	119	1.88	4%	\$9,514	\$17,094	\$19,008	1.8	2.0	\$7,580	\$9,494
CZ11	PG&E	4,188	225	2.56	4%	\$10,479	\$31,872	\$22,393	3.0	2.1	\$21,392	\$11,913
CZ12	PG&E	3,675	214	2.34	4%	\$10,409	\$29,653	\$20,525	2.8	2.0	\$19,243	\$10,115
CZ12-2	SMUD	3,675	214	2.34	4%	\$10,409	\$12,823	\$20,525	1.2	2.0	\$2,414	\$10,115
CZ13	PG&E	4,818	180	2.46	4%	\$9,809	\$34,149	\$23,623	3.5	2.4	\$24,340	\$13,814
CZ14	SDG&E	6,439	153	2.71	4%	\$12,103	\$44,705	\$26,348	3.7	2.2	\$32,601	\$14,245
CZ14-2	SCE	6,439	153	2.71	4%	\$12,103	\$22,032	\$26,348	1.8	2.2	\$9,929	\$14,245
CZ15	SCE	8,802	48	2.76	5%	\$12,534	\$25,706	\$31,402	2.1	2.5	\$13,171	\$18,868
CZ16	PG&E	2,316	390	2.97	3%	\$11,999	\$22,663	\$13,888	1.9	1.2	\$10,665	\$1,890
CZ16-2	LADWP	2,316	390	2.97	3%	\$11,999	\$11,921	\$13,888	1.0	1.2	(\$78)	\$1,890



**Figure 27. Cost Effectiveness for Medium Retail Package 2 – All-Electric Federal Code Minimum**

CZ	Utility	Elec Savings (kWh)	Gas Savings (therms)	GHG Reductions (mtons)	Compliance Margin	Incremental Package Cost*	Lifecycle Utility Cost Savings	\$TDV Savings	B/C Ratio (On-bill)	B/C Ratio (TDV)	NPV (On-bill)	NPV (TDV)
<b>Package 2: All-Electric Federal Code Minimum</b>												
CZ01	PG&E	-29,155	3893	13.85	-4.1%	(\$23,048)	(\$8,333)	(\$13,910)	2.8	1.7	\$14,715	\$9,138
CZ02	PG&E	-21,786	2448	7.49	-1.0%	(\$27,464)	(\$16,476)	(\$4,483)	1.7	6.1	\$10,987	\$22,981
CZ03	PG&E	-14,583	1868	6.26	-0.4%	(\$24,111)	\$263	(\$1,450)	>1	16.6	\$24,374	\$22,661
CZ04	PG&E	-14,186	1706	5.30	-0.1%	(\$22,896)	(\$8,753)	(\$220)	2.6	104.2	\$14,143	\$22,676
CZ04-2	CPAU	-14,186	1706	5.30	-0.1%	(\$22,896)	\$12,493	(\$220)	>1	104.2	\$35,389	\$22,676
CZ05	PG&E	-14,334	1746	5.47	-1.2%	(\$25,507)	(\$1,567)	(\$4,197)	16.3	6.1	\$23,940	\$21,309
CZ06	SCE	-7,527	1002	3.32	0.5%	(\$21,762)	\$18,590	\$1,868	>1	>1	\$40,351	\$23,630
CZ06-2	LADWP	-7,527	1002	3.32	0.5%	(\$21,762)	\$19,309	\$1,868	>1	>1	\$41,071	\$23,630
CZ07	SDG&E	-3,812	522	1.76	0.3%	(\$23,762)	\$54,345	\$1,318	>1	>1	\$78,107	\$25,080
CZ08	SCE	-5,805	793	2.70	0.4%	(\$26,922)	\$16,735	\$1,846	>1	>1	\$43,658	\$28,768
CZ08-2	LADWP	-5,805	793	2.70	0.4%	(\$26,922)	\$17,130	\$1,846	>1	>1	\$44,052	\$28,768
CZ09	SCE	-7,241	970	3.32	0.4%	(\$32,113)	\$18,582	\$1,978	>1	>1	\$50,695	\$34,091
CZ09-2	LADWP	-7,241	970	3.32	0.4%	(\$32,113)	\$19,089	\$1,978	>1	>1	\$51,202	\$34,091
CZ10	SDG&E	-10,336	1262	3.99	0.1%	(\$27,272)	\$54,453	\$505	>1	>1	\$81,724	\$27,777
CZ10-2	SCE	-10,336	1262	3.99	0.1%	(\$27,272)	\$20,996	\$505	>1	>1	\$48,268	\$27,777
CZ11	PG&E	-19,251	2415	7.95	0.5%	(\$32,202)	(\$7,951)	\$2,615	4.1	>1	\$24,251	\$34,817
CZ12	PG&E	-19,471	2309	7.28	-0.1%	(\$32,504)	(\$14,153)	(\$461)	2.3	70.4	\$18,351	\$32,042
CZ12-2	SMUD	-19,471	2309	7.28	-0.1%	(\$32,504)	\$12,939	(\$461)	>1	70.4	\$45,443	\$32,042
CZ13	PG&E	-16,819	1983	6.15	-0.4%	(\$28,158)	(\$10,575)	(\$2,022)	2.7	13.9	\$17,582	\$26,136
CZ14	SDG&E	-13,208	1672	5.44	0.7%	(\$26,656)	\$41,117	\$4,461	>1	>1	\$67,772	\$31,117
CZ14-2	SCE	-13,208	1672	5.44	0.7%	(\$26,656)	\$18,467	\$4,461	>1	>1	\$45,123	\$31,117
CZ15	SCE	-2,463	518	2.14	0.9%	(\$29,544)	\$16,796	\$5,823	>1	>1	\$46,339	\$35,367
CZ16	PG&E	-41,418	4304	13.23	-12.2%	(\$25,771)	(\$49,862)	(\$52,542)	0.5	0.5	(\$24,091)	(\$26,771)
CZ16-2	LADWP	-41,418	4304	13.23	-12.2%	(\$25,771)	\$39,319	(\$52,542)	>1	0.5	\$65,090	(\$26,771)

\*The Incremental Package Cost is the addition of the incremental HVAC and water heating equipment costs from Figure 11 and the natural gas infrastructure incremental cost savings of \$28,027 (see section 3.3.2.2).





**Figure 28. Cost Effectiveness for Medium Retail Package 3A – All-Electric + EE**

CZ	Utility	Elec Savings (kWh)	Gas Savings (therms)	GHG Reductions (mtons)	Compliance Margin	Incremental Package Cost	Lifecycle Utility Cost Savings	\$TDV Savings	B/C Ratio (On-bill)	B/C Ratio (TDV)	NPV (On-bill)	NPV (TDV)
<b>Package 3A: All-Electric + EE</b>												
CZ01	PG&E	-5,478	3893	20.64	15%	(\$20,336)	\$63,593	\$51,224	>1	>1	\$83,929	\$71,560
CZ02	PG&E	2,843	2448	14.58	13%	(\$21,895)	\$74,997	\$56,893	>1	>1	\$96,892	\$78,788
CZ03	PG&E	7,791	1868	12.73	16%	(\$18,542)	\$68,968	\$56,586	>1	>1	\$87,511	\$75,128
CZ04	PG&E	8,572	1706	11.89	14%	(\$17,327)	\$81,957	\$57,904	>1	>1	\$99,284	\$75,231
CZ04-2	CPAU	8,572	1706	11.89	14%	(\$17,327)	\$63,082	\$57,904	>1	>1	\$80,408	\$75,231
CZ05	PG&E	6,973	1746	11.68	15%	(\$19,938)	\$63,677	\$51,949	>1	>1	\$83,615	\$71,887
CZ06	SCE	7,431	1002	7.72	11%	(\$19,050)	\$47,072	\$42,610	>1	>1	\$66,122	\$61,660
CZ06-2	LADWP	7,431	1002	7.72	11%	(\$19,050)	\$37,078	\$42,610	>1	>1	\$56,128	\$61,660
CZ07	SDG&E	14,350	522	6.98	13%	(\$18,193)	\$127,461	\$50,828	>1	>1	\$145,654	\$69,021
CZ08	SCE	8,524	793	6.90	10%	(\$24,210)	\$43,679	\$42,258	>1	>1	\$67,890	\$66,468
CZ08-2	LADWP	8,524	793	6.90	10%	(\$24,210)	\$34,038	\$42,258	>1	>1	\$58,248	\$66,468
CZ09	SCE	8,403	970	7.81	10%	(\$26,545)	\$47,819	\$47,356	>1	>1	\$74,364	\$73,901
CZ09-2	LADWP	8,403	970	7.81	10%	(\$26,545)	\$37,934	\$47,356	>1	>1	\$64,478	\$73,901
CZ10	SDG&E	11,737	1262	10.23	12%	(\$21,703)	\$137,436	\$58,761	>1	>1	\$159,139	\$80,464
CZ10-2	SCE	11,737	1262	10.23	12%	(\$21,703)	\$58,257	\$58,761	>1	>1	\$79,959	\$80,464
CZ11	PG&E	5,892	2415	15.13	12%	(\$26,633)	\$85,256	\$65,859	>1	>1	\$111,889	\$92,492
CZ12	PG&E	5,548	2309	14.46	12%	(\$26,935)	\$80,631	\$63,903	>1	>1	\$107,566	\$90,838
CZ12-2	SMUD	5,548	2309	14.46	12%	(\$26,935)	\$59,311	\$63,903	>1	>1	\$86,246	\$90,838
CZ13	PG&E	10,184	1983	14.15	14%	(\$25,446)	\$110,105	\$80,604	>1	>1	\$135,551	\$106,050
CZ14	SDG&E	16,583	1672	13.83	15%	(\$23,944)	\$171,200	\$88,471	>1	>1	\$195,145	\$112,415
CZ14-2	SCE	16,583	1672	13.83	15%	(\$23,944)	\$656,178	\$159,604	>1	>1	\$680,122	\$183,548
CZ15	SCE	23,642	518	9.44	12%	(\$26,832)	\$65,573	\$76,781	>1	>1	\$92,404	\$103,612
CZ16	PG&E	-18,232	4304	19.80	3%	(\$23,059)	\$38,796	\$14,152	>1	>1	\$61,855	\$37,211
CZ16-2	LADWP	-18,232	4304	19.80	3%	(\$23,059)	\$67,793	\$14,152	>1	>1	\$90,852	\$37,211



**Figure 29. Cost Effectiveness for Medium Retail Package 3B – All-Electric + EE + PV + B**

CZ	IOU territory	Elec Savings (kWh)	Gas Savings (therms)	GHG savings (tons)	Compliance Margin (%)	Incremental Package Cost	Lifecycle Energy Cost Savings	-\$TDV Savings	B/C Ratio (On-bill)	B/C Ratio (TDV)	NPV (On-bill)	NPV (TDV)
<b>All-Electric + PV + B</b>												
CZ01	PG&E	137,956	3893	50.51	15%	\$254,335	\$510,831	\$374,432	2.0	1.5	\$256,496	\$120,097
CZ02	PG&E	173,387	2448	49.87	13%	\$252,777	\$590,112	\$463,431	2.3	1.8	\$337,336	\$210,654
CZ03	PG&E	180,055	1868	48.55	16%	\$256,129	\$585,861	\$452,399	2.3	1.8	\$329,732	\$196,270
CZ04	PG&E	184,499	1706	48.38	14%	\$257,345	\$608,814	\$481,011	2.4	1.9	\$351,470	\$223,666
CZ04-2	CPAU	184,499	1706	48.38	14%	\$257,345	\$465,690	\$481,011	1.8	1.9	\$208,345	\$223,666
CZ05	PG&E	185,690	1746	48.84	15%	\$254,734	\$600,933	\$461,804	2.4	1.8	\$346,199	\$207,071
CZ06	SCE	180,968	1002	43.91	11%	\$255,621	\$335,909	\$457,959	1.3	1.8	\$80,288	\$202,337
CZ06-2	LADWP	180,968	1002	43.91	11%	\$255,621	\$206,021	\$457,959	0.8	1.8	(\$49,601)	\$202,337
CZ07	SDG&E	194,837	522	44.67	13%	\$256,478	\$550,714	\$478,637	2.1	1.9	\$294,236	\$222,159
CZ08	SCE	184,120	793	43.32	10%	\$250,461	\$340,301	\$479,406	1.4	1.9	\$89,840	\$228,945
CZ08-2	LADWP	184,120	793	43.32	10%	\$250,461	\$203,813	\$479,406	0.8	1.9	(\$46,648)	\$228,945
CZ09	SCE	186,346	970	44.77	10%	\$248,127	\$349,524	\$474,176	1.4	1.9	\$101,397	\$226,049
CZ09-2	LADWP	186,346	970	44.77	10%	\$248,127	\$216,654	\$474,176	0.9	1.9	(\$31,473)	\$226,049
CZ10	SDG&E	191,923	1262	47.46	12%	\$252,969	\$593,514	\$473,605	2.3	1.9	\$340,545	\$220,636
CZ10-2	SCE	191,923	1262	47.46	12%	\$252,969	\$356,958	\$473,605	1.4	1.9	\$103,989	\$220,636
CZ11	PG&E	177,639	2415	50.26	12%	\$248,039	\$585,689	\$489,317	2.4	2.0	\$337,650	\$241,278
CZ12	PG&E	176,919	2309	49.46	12%	\$247,736	\$591,104	\$484,702	2.4	2.0	\$343,368	\$236,966
CZ12-2	SMUD	176,919	2309	49.46	12%	\$247,736	\$335,286	\$484,702	1.4	2.0	\$87,550	\$236,966
CZ13	PG&E	183,129	1983	49.48	14%	\$249,226	\$608,560	\$483,670	2.4	1.9	\$359,334	\$234,444
CZ14	SDG&E	208,183	1672	52.54	15%	\$250,727	\$593,232	\$544,079	2.4	2.2	\$342,505	\$293,351
CZ14-2	SCE	264,589	1672	80.97	15%	\$250,727	\$656,178	\$580,403	2.6	2.3	\$405,450	\$329,676
CZ15	SCE	205,869	518	45.67	12%	\$247,840	\$347,125	\$493,339	1.4	2.0	\$99,285	\$245,499
CZ16	PG&E	176,114	4304	60.13	3%	\$251,612	\$567,822	\$446,795	2.3	1.8	\$316,210	\$195,183
CZ16-2	LADWP	176,114	4304	60.13	3%	\$251,612	\$241,757	\$446,795	1.0	1.8	(\$9,856)	\$195,183



**Figure 30. Cost Effectiveness for Medium Retail Package 3C – All-Electric + HE**

CZ	Utility	Elec Savings (kWh)	Gas Savings (therms)	GHG Reductions (mtons)	Compliance Margin	Incremental Package Cost	Lifecycle Utility Cost Savings	\$TDV Savings	B/C Ratio (On-bill)	B/C Ratio (TDV)	NPV (On-bill)	NPV (TDV)
<b>Package 3C: All-Electric + HE</b>												
CZ01	PG&E	-26,199	3893	14.76	-2%	(\$587)	\$369	(\$5,757)	>1	0.1	\$956	(\$5,170)
CZ02	PG&E	-16,989	2448	8.95	3%	(\$4,211)	\$12,323	\$11,251	>1	>1	\$16,534	\$15,463
CZ03	PG&E	-11,703	1868	7.15	2%	(\$2,213)	\$9,159	\$6,944	>1	>1	\$11,372	\$9,157
CZ04	PG&E	-10,675	1706	6.37	3%	(\$316)	\$14,317	\$11,383	>1	>1	\$14,633	\$11,700
CZ04-2	CPAU	-10,675	1706	6.37	3%	(\$316)	\$20,599	\$11,383	>1	>1	\$20,915	\$11,700
CZ05	PG&E	-11,969	1746	6.19	1%	(\$2,298)	\$5,592	\$1,824	>1	>1	\$7,890	\$4,122
CZ06	SCE	-3,919	1002	4.35	3%	\$1,418	\$29,751	\$13,734	21.0	9.7	\$28,333	\$12,316
CZ06-2	LADWP	-3,919	1002	4.35	3%	\$1,418	\$25,891	\$13,734	18.3	9.7	\$24,473	\$12,316
CZ07	SDG&E	-955	522	2.59	3%	(\$710)	\$74,518	\$11,229	>1	>1	\$75,227	\$11,939
CZ08	SCE	-2,224	793	3.74	4%	(\$3,719)	\$28,067	\$15,075	>1	>1	\$31,785	\$18,793
CZ08-2	LADWP	-2,224	793	3.74	4%	(\$3,719)	\$23,848	\$15,075	>1	>1	\$27,566	\$18,793
CZ09	SCE	-2,089	970	4.84	4%	(\$8,268)	\$34,648	\$21,162	>1	>1	\$42,916	\$29,430
CZ09-2	LADWP	-2,089	970	4.84	4%	(\$8,268)	\$28,837	\$21,162	>1	>1	\$37,105	\$29,430
CZ10	SDG&E	-4,868	1262	5.58	4%	(\$5,222)	\$91,136	\$20,041	>1	>1	\$96,358	\$25,263
CZ10-2	SCE	-4,868	1262	5.58	4%	(\$5,222)	\$37,200	\$20,041	>1	>1	\$42,422	\$25,263
CZ11	PG&E	-12,651	2415	9.95	5%	(\$8,217)	\$29,015	\$26,172	>1	>1	\$37,232	\$34,389
CZ12	PG&E	-13,479	2309	9.10	4%	(\$9,239)	\$20,839	\$21,228	>1	>1	\$30,078	\$30,466
CZ12-2	SMUD	-13,479	2309	9.10	4%	(\$9,239)	\$26,507	\$21,228	>1	>1	\$35,746	\$30,466
CZ13	PG&E	-9,935	1983	8.23	4%	(\$4,975)	\$30,123	\$24,063	>1	>1	\$35,097	\$29,037
CZ14	SDG&E	-5,407	1672	7.71	5%	\$121	\$88,669	\$31,029	732.5	256.3	\$88,547	\$30,908
CZ14-2	SCE	-5,407	1672	7.71	5%	\$121	\$40,709	\$31,029	336.3	256.3	\$40,588	\$30,908
CZ15	SCE	6,782	518	4.77	6%	(\$2,508)	\$42,238	\$37,379	>1	>1	\$44,745	\$39,887
CZ16	PG&E	-35,297	4304	15.03	-8%	\$1,102	(\$21,384)	(\$33,754)	-19.4	-30.6	(\$22,486)	(\$34,856)
CZ16-2	LADWP	-35,297	4304	15.03	-8%	\$1,102	\$48,625	(\$33,754)	44.1	-30.6	\$47,523	(\$34,856)



### 4.3 Cost Effectiveness Results – Small Hotel

The following issues must be considered when reviewing the Small Hotel results:

- ◆ The Small Hotel is a mix of residential and nonresidential space types, which results in different occupancy and load profiles than the office and retail prototypes.
- ◆ A potential laundry load has not been examined for the Small Hotel. The Reach Code Team attempted to characterize and apply the energy use intensity of laundry loads in hotels but did not find readily available data for use. Thus, cost effectiveness including laundry systems has not been examined.
- ◆ Contrary to the office and retail prototypes, the Small Hotel baseline water heater is a central gas storage type. Current compliance software cannot model central heat pump water heater systems with recirculation serving guest rooms.<sup>23</sup> The only modeling option for heat pump water heating is individual water heaters at each guest room even though this is a very uncommon configuration. TRC modeled individual heat pump water heaters but as a proxy for central heat pump water heating performance, but integrated costs associated with tank and controls for central heat pump water heating into cost effectiveness calculations.
- ◆ Assuming central heat pump water heating also enabled the inclusion of a solar hot water thermal collection system, which was a key efficiency measure to achieving compliance in nearly all climate zones.

Figure 31 through Figure 37 contain the cost-effectiveness findings for the Small Hotel packages. Notable findings for each package include:

- ◆ **1A – Mixed-Fuel + EE:**
  - ◆ Packages achieve +3 to +10% compliance margins depending on climate zone.
  - ◆ Packages are cost effective using either the On-Bill or TDV approach in all CZs except 12 (using SMUD rates), 14 (using SCE rates), and 15 (with SCE rates).
  - ◆ The hotel is primarily guest rooms with a smaller proportion of nonresidential space. Thus, the inexpensive VAV minimum flow measure and lighting measures that have been applied to the entirety of the Medium Office and Medium Retail prototypes have a relatively small impact in the Small Hotel.<sup>24</sup>
- ◆ **1B – Mixed-Fuel + EE + PV + B:** Packages are cost effective using either the On-Bill or TDV approach in all CZs. Solar PV generally increases cost effectiveness compared to efficiency-only, particularly when using an NPV metric.
- ◆ **1C – Mixed-Fuel + HE:** Packages achieve +2 to +5% compliance margins depending on climate zone. The package is cost effective using the On-Bill approach in a minority of climate zones, and cost effective using TDV approach only in CZ15.

<sup>23</sup> The IOUs and CEC are actively working on including central heat pump water heater modeling with recirculation systems in early 2020.

<sup>24</sup> Title 24 requires that hotel/motel guest room lighting design comply with the residential lighting standards, which are all mandatory and are not awarded compliance credit for improved efficacy.



◆ **2 – All-Electric Federal Code-Minimum Reference:**

◆ This all-electric design does not comply with the Energy Commission's TDV performance budget. Packages achieve between -50% and -4% compliance margins depending on climate zone. This may be because the modeled HW system is constrained to having an artificially low efficiency to avoid triggering federal pre-emption, and the heat pump space heating systems must operate overnight when operation is less efficient.

◆ All packages are cost effective in all climate zones.

◆ **3A – All-Electric + EE:** Packages achieve positive compliance margins in all CZs ranging from 0% to +17%, except CZ16 which had a -18% compliance margin. All packages are cost effective in all climate zones. The improved degree of cost effectiveness outcomes in Package 3A compared to Package 1A appear to be due to the significant incremental package cost savings.

◆ **3B – All-Electric + EE + PV + B:** All packages are cost effective. Packages improve in B/C ratio when compared to 3A and increase in magnitude of overall NPV savings. PV appears to be more cost-effective with higher building electricity loads.

◆ **3C – All-Electric + HE:**

◆ Packages do not comply with Title 24 in all CZs except CZ15 which resulted in a +0.04% compliance margin.

◆ All packages are cost effective.



**Figure 31. Cost Effectiveness for Small Hotel Package 1A – Mixed-Fuel + EE**

CZ	Utility	Elec Savings (kWh)	Gas Savings (therms)	GHG Reductions (mtons)	Compliance Margin	Incremental Package Cost	Lifecycle Utility Cost Savings	\$TDV Savings	B/C Ratio (On-bill)	B/C Ratio (TDV)	NPV (On-bill)	NPV (TDV)
<b>Package 1A: Mixed Fuel + EE</b>												
CZ01	PG&E	3,855	1288	5.65	9%	\$20,971	\$34,339	\$36,874	1.6	1.8	\$13,368	\$15,903
CZ02	PG&E	3,802	976	3.91	7%	\$20,971	\$26,312	\$29,353	1.3	1.4	\$5,341	\$8,381
CZ03	PG&E	4,153	1046	4.48	10%	\$20,971	\$31,172	\$35,915	1.5	1.7	\$10,201	\$14,944
CZ04	PG&E	5,007	395	0.85	6%	\$21,824	\$24,449	\$24,270	1.1	1.1	\$2,625	\$2,446
CZ04-2	CPAU	4,916	422	0.98	6%	\$21,824	\$18,713	\$24,306	0.9	1.1	(\$3,111)	\$2,483
CZ05	PG&E	3,530	1018	4.13	9%	\$20,971	\$28,782	\$34,448	1.4	1.6	\$7,810	\$13,477
CZ05-2	SCG	3,530	1018	4.13	9%	\$20,971	\$23,028	\$34,448	1.1	1.6	\$2,057	\$13,477
CZ06	SCE	5,137	418	1.16	8%	\$21,824	\$16,001	\$26,934	0.7	1.2	(\$5,823)	\$5,110
CZ06-2	LADWP	5,137	418	1.16	8%	\$21,824	\$11,706	\$26,934	0.5	1.2	(\$10,118)	\$5,110
CZ07	SDG&E	5,352	424	1.31	8%	\$21,824	\$26,699	\$27,975	1.2	1.3	\$4,876	\$6,152
CZ08	SCE	5,151	419	1.21	7%	\$21,824	\$15,931	\$23,576	0.7	1.1	(\$5,893)	\$1,752
CZ08-2	LADWP	5,151	419	1.21	7%	\$21,824	\$11,643	\$23,576	0.5	1.1	(\$10,180)	\$1,752
CZ09	SCE	5,229	406	1.16	6%	\$21,824	\$15,837	\$22,365	0.7	1.0	(\$5,987)	\$541
CZ09-2	LADWP	5,229	406	1.16	6%	\$21,824	\$11,632	\$22,365	0.5	1.0	(\$10,192)	\$541
CZ10	SDG&E	4,607	342	0.92	5%	\$21,824	\$25,506	\$22,219	1.2	1.0	\$3,683	\$396
CZ10-2	SCE	4,607	342	0.92	5%	\$21,824	\$13,868	\$22,219	0.6	1.0	(\$7,956)	\$396
CZ11	PG&E	4,801	325	0.87	4%	\$21,824	\$22,936	\$19,503	1.1	0.9	\$1,112	(\$2,321)
CZ12	PG&E	5,276	327	0.90	5%	\$21,824	\$22,356	\$21,305	1.0	0.98	\$532	(\$519)
CZ12-2	SMUD	5,276	327	0.90	5%	\$21,824	\$15,106	\$21,305	0.7	0.98	(\$6,717)	(\$519)
CZ13	PG&E	4,975	310	0.87	4%	\$21,824	\$23,594	\$19,378	1.1	0.9	\$1,770	(\$2,445)
CZ14	SDG&E	4,884	370	0.82	4%	\$21,824	\$24,894	\$21,035	1.1	0.96	\$3,070	(\$789)
CZ14-2	SCE	4,884	370	0.82	4%	\$21,824	\$14,351	\$21,035	0.7	0.96	(\$7,473)	(\$789)
CZ15	SCE	5,187	278	1.23	3%	\$21,824	\$13,645	\$18,089	0.6	0.8	(\$8,178)	(\$3,735)
CZ16	PG&E	2,992	1197	4.95	6%	\$20,971	\$27,813	\$30,869	1.3	1.5	\$6,842	\$9,898
CZ16-2	LADWP	2,992	1197	4.95	6%	\$20,971	\$19,782	\$30,869	0.9	1.5	(\$1,190)	\$9,898



**Figure 32. Cost Effectiveness for Small Hotel Package 1B – Mixed-Fuel + EE + PV + B**

CZ	Utility	Elec Savings (kWh)	Gas Savings (therms)	GHG Reductions (mtons)	Compliance Margin	Incremental Package Cost	Lifecycle Utility Cost Savings	\$TDV Savings	B/C Ratio (On-bill)	B/C Ratio (TDV)	NPV (On-bill)	NPV (TDV)
<b>Package 1B: Mixed Fuel + EE + PV + B</b>												
CZ01	PG&E	107,694	1288	28.73	9%	\$228,341	\$366,509	\$295,731	1.6	1.3	\$138,168	\$67,390
CZ02	PG&E	130,144	976	31.14	7%	\$228,341	\$359,248	\$336,575	1.6	1.5	\$130,907	\$108,233
CZ03	PG&E	129,107	1046	31.57	10%	\$228,341	\$430,737	\$335,758	1.9	1.5	\$202,396	\$107,416
CZ04	PG&E	132,648	395	28.46	6%	\$229,194	\$355,406	\$338,455	1.6	1.5	\$126,212	\$109,262
CZ04-2	CPAU	132,556	422	28.59	6%	\$229,194	\$322,698	\$338,492	1.4	1.5	\$93,504	\$109,298
CZ05	PG&E	136,318	1018	32.73	9%	\$228,341	\$452,611	\$352,342	2.0	1.5	\$224,269	\$124,001
CZ05-2	SCG	136,318	1018	32.73	9%	\$228,341	\$446,858	\$352,342	2.0	1.5	\$218,516	\$124,001
CZ06	SCE	131,051	418	28.47	8%	\$229,194	\$217,728	\$336,843	0.9	1.5	(\$11,466)	\$107,649
CZ06-2	LADWP	131,051	418	28.47	8%	\$229,194	\$131,052	\$336,843	0.6	1.5	(\$98,142)	\$107,649
CZ07	SDG&E	136,359	424	29.63	8%	\$229,194	\$306,088	\$345,378	1.3	1.5	\$76,894	\$116,184
CZ08	SCE	132,539	419	28.85	7%	\$229,194	\$227,297	\$353,013	1.0	1.5	(\$1,897)	\$123,819
CZ08-2	LADWP	132,539	419	28.85	7%	\$229,194	\$134,739	\$353,013	0.6	1.5	(\$94,455)	\$123,819
CZ09	SCE	131,422	406	28.82	6%	\$229,194	\$230,791	\$343,665	1.0	1.5	\$1,597	\$114,471
CZ09-2	LADWP	131,422	406	28.82	6%	\$229,194	\$136,024	\$343,665	0.6	1.5	(\$93,170)	\$114,471
CZ10	SDG&E	134,146	342	29.05	5%	\$229,194	\$339,612	\$342,574	1.5	1.5	\$110,418	\$113,380
CZ10-2	SCE	134,146	342	29.05	5%	\$229,194	\$226,244	\$342,574	1.0	1.5	(\$2,949)	\$113,380
CZ11	PG&E	128,916	325	27.62	4%	\$229,194	\$352,831	\$337,208	1.5	1.5	\$123,637	\$108,014
CZ12	PG&E	131,226	327	28.04	5%	\$229,194	\$425,029	\$338,026	1.9	1.5	\$195,835	\$108,832
CZ12-2	SMUD	131,226	327	28.04	5%	\$229,194	\$213,176	\$338,026	0.9	1.5	(\$16,018)	\$108,832
CZ13	PG&E	127,258	310	27.33	4%	\$229,194	\$351,244	\$324,217	1.5	1.4	\$122,050	\$95,023
CZ14	SDG&E	147,017	370	30.96	4%	\$229,194	\$861,445	\$217,675	3.8	0.9	\$632,251	(\$11,518)
CZ14-2	SCE	147,017	370	30.96	4%	\$229,194	\$244,100	\$381,164	1.1	1.7	\$14,906	\$151,970
CZ15	SCE	137,180	278	29.12	3%	\$229,194	\$225,054	\$348,320	1.0	1.5	(\$4,140)	\$119,127
CZ16	PG&E	141,478	1197	34.60	6%	\$228,341	\$377,465	\$357,241	1.7	1.6	\$149,124	\$128,899
CZ16-2	LADWP	141,478	1197	34.60	6%	\$228,341	\$136,563	\$357,241	0.6	1.6	(\$91,778)	\$128,899



**Figure 33. Cost Effectiveness for Small Hotel Package 1C - Mixed-Fuel + HE**

CZ	Utility	Elec Savings (kWh)	Gas Savings (therms)	GHG Reductions (mtons)	Compliance Margin	Incremental Package Cost	Lifecycle Utility Cost Savings	\$TDV Savings	B/C Ratio (On-bill)	B/C Ratio (TDV)	NPV (On-bill)	NPV (TDV)
<b>Package 1C: Mixed Fuel + HE</b>												
CZ01	PG&E	10	632	3.76	2%	\$22,839	\$11,015	\$10,218	0.5	0.4	(\$11,823)	(\$12,621)
CZ02	PG&E	981	402	2.69	3%	\$23,092	\$16,255	\$11,808	0.7	0.5	(\$6,837)	(\$11,284)
CZ03	PG&E	81	383	2.30	2%	\$20,510	\$7,066	\$6,850	0.3	0.3	(\$13,444)	(\$13,660)
CZ04	PG&E	161	373	2.26	2%	\$22,164	\$8,593	\$7,645	0.4	0.3	(\$13,571)	(\$14,519)
CZ04-2	CPAU	161	373	2.26	2%	\$22,164	\$7,097	\$7,645	0.3	0.3	(\$15,067)	(\$14,519)
CZ05	PG&E	154	361	2.19	2%	\$21,418	\$6,897	\$6,585	0.3	0.3	(\$14,521)	(\$14,833)
CZ05-2	SCG	154	361	2.19	2%	\$21,418	\$4,786	\$6,585	0.2	0.3	(\$16,632)	(\$14,833)
CZ06	SCE	237	201	1.27	2%	\$20,941	\$3,789	\$4,882	0.2	0.2	(\$17,152)	(\$16,059)
CZ06-2	LADWP	237	201	1.27	2%	\$20,941	\$3,219	\$4,882	0.2	0.2	(\$17,722)	(\$16,059)
CZ07	SDG&E	1,117	158	1.28	2%	\$19,625	\$13,771	\$7,342	0.7	0.4	(\$5,854)	(\$12,283)
CZ08	SCE	1,302	169	1.39	2%	\$20,678	\$8,378	\$8,591	0.4	0.4	(\$12,300)	(\$12,088)
CZ08-2	LADWP	1,302	169	1.39	2%	\$20,678	\$5,802	\$8,591	0.3	0.4	(\$14,877)	(\$12,088)
CZ09	SCE	1,733	178	1.56	3%	\$20,052	\$10,489	\$11,164	0.5	0.6	(\$9,563)	(\$8,888)
CZ09-2	LADWP	1,733	178	1.56	3%	\$20,052	\$7,307	\$11,164	0.4	0.6	(\$12,745)	(\$8,888)
CZ10	SDG&E	3,170	220	2.29	4%	\$22,682	\$35,195	\$19,149	1.6	0.8	\$12,513	(\$3,533)
CZ10-2	SCE	3,170	220	2.29	4%	\$22,682	\$16,701	\$19,149	0.7	0.8	(\$5,981)	(\$3,533)
CZ11	PG&E	3,343	323	2.96	4%	\$23,344	\$27,633	\$20,966	1.2	0.9	\$4,288	(\$2,379)
CZ12	PG&E	1,724	320	2.44	4%	\$22,302	\$11,597	\$15,592	0.5	0.7	(\$10,705)	(\$6,710)
CZ12-2	SMUD	1,724	320	2.44	4%	\$22,302	\$11,156	\$15,592	0.5	0.7	(\$11,146)	(\$6,710)
CZ13	PG&E	3,083	316	2.81	3%	\$22,882	\$23,950	\$17,068	1.0	0.7	\$1,068	(\$5,814)
CZ14	SDG&E	3,714	312	2.99	4%	\$23,299	\$35,301	\$21,155	1.5	0.9	\$12,002	(\$2,144)
CZ14-2	SCE	3,714	312	2.99	4%	\$23,299	\$18,460	\$21,155	0.8	0.9	(\$4,839)	(\$2,144)
CZ15	SCE	8,684	97	3.21	5%	\$20,945	\$26,738	\$31,600	1.3	1.5	\$5,792	\$10,655
CZ16	PG&E	836	700	4.42	3%	\$24,616	\$18,608	\$14,494	0.8	0.6	(\$6,007)	(\$10,121)
CZ16-2	LADWP	836	700	4.42	3%	\$24,616	\$15,237	\$14,494	0.6	0.6	(\$9,378)	(\$10,121)





**Figure 34. Cost Effectiveness for Small Hotel Package 2 – All-Electric Federal Code Minimum**

CZ	Utility	Elec Savings (kWh)	Gas Savings (therms)	GHG Reductions (mtons)	Compliance Margin	Incremental Package Cost*	Lifecycle Utility Cost Savings	\$TDV Savings	B/C Ratio (On-bill)	B/C Ratio (TDV)	NPV (On-bill)	NPV (TDV)
<b>Package 2: All-Electric Federal Code Minimum</b>												
CZ01	PG&E	-159,802	16917	53.92	-28%	(\$1,296,784)	(\$582,762)	(\$115,161)	2.2	11.3	\$714,022	\$1,181,623
CZ02	PG&E	-118,739	12677	40.00	-12%	(\$1,297,757)	(\$245,434)	(\$51,620)	5.3	25.1	\$1,052,322	\$1,246,137
CZ03	PG&E	-110,595	12322	40.48	-14%	(\$1,300,029)	(\$326,633)	(\$51,166)	4.0	25.4	\$973,396	\$1,248,863
CZ04	PG&E	-113,404	11927	36.59	-13%	(\$1,299,864)	(\$225,307)	(\$53,134)	5.8	24.5	\$1,074,556	\$1,246,730
CZ04-2	CPAU	-113,404	11927	36.59	-13%	(\$1,299,864)	(\$17,768)	(\$53,134)	73.2	24.5	\$1,282,096	\$1,246,730
CZ05	PG&E	-108,605	11960	38.34	-15%	(\$1,299,917)	(\$350,585)	(\$54,685)	3.7	23.8	\$949,332	\$1,245,232
CZ06	SCE	-78,293	8912	29.36	-5%	(\$1,300,058)	(\$61,534)	(\$28,043)	21.1	46.4	\$1,238,524	\$1,272,015
CZ06-2	LA	-78,293	8912	29.36	-5%	(\$1,300,058)	\$43,200	(\$28,043)	>1	46.4	\$1,343,258	\$1,272,015
CZ07	SDG&E	-69,819	8188	28.04	-7%	(\$1,298,406)	(\$137,638)	(\$23,199)	9.4	56.0	\$1,160,768	\$1,275,207
CZ08	SCE	-71,914	8353	28.21	-6%	(\$1,296,376)	(\$53,524)	(\$22,820)	24.2	56.8	\$1,242,852	\$1,273,556
CZ08-2	LA	-71,914	8353	28.21	-6%	(\$1,296,376)	\$42,841	(\$22,820)	>1	56.8	\$1,339,217	\$1,273,556
CZ09	SCE	-72,262	8402	28.38	-6%	(\$1,298,174)	(\$44,979)	(\$21,950)	28.9	59.1	\$1,253,196	\$1,276,224
CZ09-2	LA	-72,262	8402	28.38	-6%	(\$1,298,174)	\$46,679	(\$21,950)	>1	59.1	\$1,344,853	\$1,276,224
CZ10	SDG&E	-80,062	8418	26.22	-8%	(\$1,295,176)	(\$172,513)	(\$36,179)	7.5	35.8	\$1,122,663	\$1,258,997
CZ10-2	SCE	-80,062	8418	26.22	-8%	(\$1,295,176)	(\$63,974)	(\$36,179)	20.2	35.8	\$1,231,202	\$1,258,997
CZ11	PG&E	-99,484	10252	30.99	-10%	(\$1,295,985)	(\$186,037)	(\$49,387)	7.0	26.2	\$1,109,948	\$1,246,598
CZ12	PG&E	-99,472	10403	32.08	-10%	(\$1,297,425)	(\$340,801)	(\$45,565)	3.8	28.5	\$956,624	\$1,251,860
CZ12-2	SMUD	-99,067	10403	32.21	-10%	(\$1,297,425)	\$5,794	(\$44,354)	>1	29.3	\$1,303,219	\$1,253,071
CZ13	PG&E	-96,829	10029	30.60	-10%	(\$1,295,797)	(\$184,332)	(\$50,333)	7.0	25.7	\$1,111,465	\$1,245,464
CZ14	SDG&E	-101,398	10056	29.68	-11%	(\$1,296,156)	(\$325,928)	(\$56,578)	4.0	22.9	\$970,228	\$1,239,578
CZ14-2	SCE	-101,398	10056	29.68	-11%	(\$1,296,156)	(\$121,662)	(\$56,578)	10.7	22.9	\$1,174,494	\$1,239,578
CZ15	SCE	-49,853	5579	18.07	-4%	(\$1,294,276)	\$209	(\$21,420)	>1	60.4	\$1,294,485	\$1,272,856
CZ16	PG&E	-216,708	17599	41.89	-50%	(\$1,300,552)	(\$645,705)	(\$239,178)	2.0	5.4	\$654,847	\$1,061,374
CZ16-2	LA	-216,708	17599	41.89	-50%	(\$1,300,552)	\$30,974	(\$239,178)	>1	5.4	\$1,331,526	\$1,061,374

\*The Incremental Package Cost is the addition of the incremental HVAC and water heating equipment costs from Figure 12, the electrical infrastructure incremental cost of \$26,800 (see section 3.3.2.1), and the natural gas infrastructure incremental cost savings of \$56,020 (see section 3.3.2.2).



**Figure 35. Cost Effectiveness for Small Hotel Package 3A – All-Electric + EE**

CZ	Utility	Elec Savings (kWh)	Gas Savings (therms)	GHG Reductions (mtons)	Compliance Margin	Incremental Package Cost	Lifecycle Utility Cost Savings	\$TDV Savings	B/C Ratio (On-bill)	B/C Ratio (TDV)	NPV (On-bill)	NPV (TDV)
<b>Package 3A: All-Electric + EE</b>												
CZ01	PG&E	-113,259	16917	62.38	1.3%	(\$1,251,544)	(\$200,367)	\$5,460	6.2	>1	\$1,051,177	\$1,257,005
CZ02	PG&E	-90,033	12677	45.46	4%	(\$1,265,064)	(\$108,075)	\$15,685	11.7	>1	\$1,156,989	\$1,280,749
CZ03	PG&E	-83,892	12322	45.93	6%	(\$1,267,509)	(\$198,234)	\$20,729	6.4	>1	\$1,069,274	\$1,288,237
CZ04	PG&E	-91,197	11927	40.36	0.2%	(\$1,263,932)	(\$112,892)	\$703	11.2	>1	\$1,151,041	\$1,264,635
CZ04-2	CPAU	-90,981	11927	40.42	0.2%	(\$1,263,932)	\$32,557	\$918	>1	>1	\$1,296,489	\$1,264,850
CZ05	PG&E	-82,491	11960	43.62	5%	(\$1,267,355)	(\$221,492)	\$18,488	5.7	>1	\$1,045,863	\$1,285,843
CZ06	SCE	-61,523	8912	32.45	7%	(\$1,267,916)	(\$33,475)	\$15,142	37.9	>1	\$1,234,441	\$1,283,057
CZ06-2	LADWP	-61,523	8912	32.45	7%	(\$1,267,916)	\$57,215	\$15,142	>1	>1	\$1,325,130	\$1,283,057
CZ07	SDG&E	-53,308	8188	31.22	7%	(\$1,266,354)	(\$81,338)	\$22,516	15.6	>1	\$1,185,015	\$1,288,870
CZ08	SCE	-55,452	8353	31.33	3%	(\$1,264,408)	(\$23,893)	\$9,391	52.9	>1	\$1,240,515	\$1,273,800
CZ08-2	LADWP	-55,452	8353	31.33	3%	(\$1,264,408)	\$57,058	\$9,391	>1	>1	\$1,321,466	\$1,273,800
CZ09	SCE	-55,887	8402	31.40	2%	(\$1,266,302)	(\$19,887)	\$9,110	63.7	>1	\$1,246,415	\$1,275,412
CZ09-2	LADWP	-55,887	8402	31.40	2%	(\$1,266,302)	\$60,441	\$9,110	>1	>1	\$1,326,743	\$1,275,412
CZ10	SDG&E	-60,239	8418	29.96	2%	(\$1,256,002)	(\$126,072)	\$7,365	10.0	>1	\$1,129,930	\$1,263,367
CZ10-2	SCE	-60,239	8418	29.96	2%	(\$1,256,002)	(\$33,061)	\$7,365	38.0	>1	\$1,222,940	\$1,263,367
CZ11	PG&E	-77,307	10252	35.12	1%	(\$1,256,149)	(\$80,187)	\$3,114	15.7	>1	\$1,175,962	\$1,259,263
CZ12	PG&E	-75,098	10403	36.73	2%	(\$1,256,824)	(\$234,275)	\$9,048	5.4	>1	\$1,022,550	\$1,265,872
CZ12-2	SMUD	-75,098	10403	36.73	2%	(\$1,256,824)	\$54,941	\$9,048	>1	>1	\$1,311,765	\$1,265,872
CZ13	PG&E	-75,052	10029	34.72	0.3%	(\$1,256,109)	(\$79,378)	\$1,260	15.8	>1	\$1,176,731	\$1,257,369
CZ14	SDG&E	-76,375	10056	34.28	0.1%	(\$1,255,704)	(\$170,975)	\$543	7.3	>1	\$1,084,729	\$1,256,247
CZ14-2	SCE	-76,375	10056	34.28	0.1%	(\$1,255,704)	(\$34,418)	\$543	36.5	>1	\$1,221,286	\$1,256,247
CZ15	SCE	-33,722	5579	21.43	2%	(\$1,257,835)	\$26,030	\$12,262	>1	>1	\$1,283,864	\$1,270,097
CZ16	PG&E	-139,676	17599	55.25	-14%	(\$1,255,364)	(\$197,174)	(\$66,650)	6.4	18.8	\$1,058,190	\$1,188,714
CZ16-2	LADWP	-139,676	17599	55.25	-14%	(\$1,255,364)	\$165,789	(\$66,650)	>1	18.8	\$1,421,153	\$1,188,714



**Figure 36. Cost Effectiveness for Small Hotel Package 3B – All-Electric + EE + PV + B**

CZ	Utility	Elec Savings (kWh)	Gas Savings (therms)	GHG Reductions (mtons)	Compliance Margin	Incremental Package Cost	Lifecycle Utility Cost Savings	\$TDV Savings	B/C Ratio (On-bill)	B/C Ratio (TDV)	NPV (On-bill)	NPV (TDV)
<b>Package 3B: All-Electric + EE + PV + B</b>												
CZ01	PG&E	-8,900	16917	87.15	1%	(\$1,044,174)	\$90,964	\$324,376	>1	>1	\$1,135,139	\$1,368,551
CZ02	PG&E	36,491	12677	73.03	4%	(\$1,057,694)	\$242,514	\$313,711	>1	>1	\$1,300,208	\$1,371,405
CZ03	PG&E	41,239	12322	73.43	6%	(\$1,060,139)	\$155,868	\$308,385	>1	>1	\$1,216,007	\$1,368,524
CZ04	PG&E	36,628	11927	69.70	0.2%	(\$1,056,562)	\$240,799	\$308,682	>1	>1	\$1,297,361	\$1,365,244
CZ04-2	CPAU	36,844	11927	69.76	0.2%	(\$1,056,562)	\$336,813	\$418,836	>1	>1	\$1,393,375	\$1,475,398
CZ05	PG&E	36,365	11960	73.11	5%	(\$1,059,985)	\$119,173	\$317,952	>1	>1	\$1,179,158	\$1,377,937
CZ06	SCE	64,476	8912	60.47	7%	(\$1,060,545)	\$156,327	\$311,730	>1	>1	\$1,216,872	\$1,372,275
CZ06-2	LADWP	64,476	8912	60.47	7%	(\$1,060,545)	\$180,648	\$311,730	>1	>1	\$1,241,193	\$1,372,275
CZ07	SDG&E	77,715	8188	60.45	7%	(\$1,058,983)	\$197,711	\$330,458	>1	>1	\$1,256,694	\$1,389,441
CZ08	SCE	71,990	8353	59.49	3%	(\$1,057,038)	\$165,393	\$320,814	>1	>1	\$1,222,432	\$1,377,852
CZ08-2	LADWP	71,990	8353	60.24	3%	(\$1,057,038)	\$180,367	\$443,809	>1	>1	\$1,237,405	\$1,500,847
CZ09	SCE	70,465	8402	59.29	2%	(\$1,058,932)	\$175,602	\$301,459	>1	>1	\$1,234,534	\$1,360,391
CZ09-2	LADWP	70,465	8402	59.29	2%	(\$1,058,932)	\$183,220	\$301,459	>1	>1	\$1,242,152	\$1,360,391
CZ10	SDG&E	69,581	8418	58.04	2%	(\$1,048,632)	\$161,513	\$294,530	>1	>1	\$1,210,145	\$1,343,162
CZ10-2	SCE	69,581	8418	58.04	2%	(\$1,048,632)	\$164,837	\$294,530	>1	>1	\$1,213,469	\$1,343,162
CZ11	PG&E	47,260	10252	61.57	1%	(\$1,048,779)	\$253,717	\$286,797	>1	>1	\$1,302,496	\$1,335,576
CZ12	PG&E	51,115	10403	64.07	2%	(\$1,049,454)	\$104,523	\$305,446	>1	>1	\$1,153,977	\$1,354,900
CZ12-2	SMUD	51,115	10403	64.99	2%	(\$1,049,454)	\$253,197	\$430,977	>1	>1	\$1,302,651	\$1,480,431
CZ13	PG&E	47,757	10029	60.77	0.3%	(\$1,048,739)	\$251,663	\$281,877	>1	>1	\$1,300,402	\$1,330,616
CZ14	SDG&E	66,084	10056	64.54	0.1%	(\$1,048,334)	\$148,510	\$334,938	>1	>1	\$1,196,844	\$1,383,272
CZ14-2	SCE	66,084	10056	64.54	0.1%	(\$1,048,334)	\$185,018	\$334,938	>1	>1	\$1,233,352	\$1,383,272
CZ15	SCE	98,755	5579	49.04	2.1%	(\$1,050,465)	\$233,308	\$311,121	>1	>1	\$1,283,772	\$1,361,585
CZ16	PG&E	-873	17599	84.99	-14%	(\$1,047,994)	\$191,994	\$240,724	>1	>1	\$1,239,987	\$1,288,718
CZ16-2	LADWP	-873	17599	84.99	-14%	(\$1,047,994)	\$291,279	\$240,724	>1	>1	\$1,339,273	\$1,288,718



**Figure 37. Cost Effectiveness for Small Hotel Package 3C - All-Electric + HE**

CZ	Utility	Elec Savings (kWh)	Gas Savings (therms)	GHG Reductions (mtons)	Compliance Margin	Incremental Package Cost	Lifecycle Utility Cost Savings	\$TDV Savings	B/C Ratio (On-bill)	B/C Ratio (TDV)	NPV (On-bill)	NPV (TDV)
<b>Package 3C: All-Electric + HE</b>												
CZ01	PG&E	-154,840	16917	56.24	-24%	(\$1,281,338)	(\$606,619)	(\$101,272)	2.1	12.7	\$674,719	\$1,180,066
CZ02	PG&E	-118,284	12677	41.18	-11%	(\$1,283,243)	(\$395,641)	(\$44,505)	3.2	28.8	\$887,602	\$1,238,738
CZ03	PG&E	-113,413	12322	40.80	-14%	(\$1,288,782)	(\$522,458)	(\$51,582)	2.5	25.0	\$766,324	\$1,237,200
CZ04	PG&E	-115,928	11927	37.09	-13%	(\$1,287,878)	(\$383,177)	(\$53,285)	3.4	24.2	\$904,701	\$1,234,593
CZ04-2	CPAU	-115,928	11927	37.09	-13%	(\$1,287,878)	(\$24,170)	(\$53,285)	53.3	24.2	\$1,263,708	\$1,234,593
CZ05	PG&E	-111,075	11960	38.75	-15%	(\$1,288,242)	(\$530,740)	(\$56,124)	2.4	23.0	\$757,502	\$1,232,119
CZ06	SCE	-83,000	8912	29.41	-15%	(\$1,288,695)	(\$154,625)	(\$32,244)	8.3	40.0	\$1,134,069	\$1,256,451
CZ06-2	LADWP	-83,000	8912	29.41	-15%	(\$1,288,695)	(\$17,626)	(\$32,244)	73.1	40.0	\$1,271,068	\$1,256,451
CZ07	SDG&E	-73,823	8188	28.32	-7%	(\$1,285,759)	(\$268,207)	(\$24,069)	4.8	53.4	\$1,017,552	\$1,261,690
CZ08	SCE	-75,573	8353	28.56	-6%	(\$1,281,241)	(\$157,393)	(\$21,912)	8.1	58.5	\$1,123,848	\$1,259,329
CZ08-2	LADWP	-75,573	8353	28.56	-6%	(\$1,281,241)	(\$18,502)	(\$21,912)	69.2	58.5	\$1,262,739	\$1,259,329
CZ09	SCE	-74,790	8402	29.04	-4%	(\$1,285,139)	(\$138,746)	(\$16,992)	9.3	75.6	\$1,146,393	\$1,268,147
CZ09-2	LADWP	-74,790	8402	29.04	-4%	(\$1,285,139)	(\$6,344)	(\$16,992)	202.6	75.6	\$1,278,794	\$1,268,147
CZ10	SDG&E	-80,248	8418	27.57	-5%	(\$1,278,097)	(\$235,479)	(\$24,107)	5.4	53.0	\$1,042,617	\$1,253,990
CZ10-2	SCE	-80,248	8418	27.57	-5%	(\$1,278,097)	(\$123,371)	(\$24,107)	10.4	53.0	\$1,154,726	\$1,253,990
CZ11	PG&E	-98,041	10252	32.73	-7%	(\$1,279,528)	(\$278,242)	(\$35,158)	4.6	36.4	\$1,001,286	\$1,244,370
CZ12	PG&E	-100,080	10403	33.24	-9%	(\$1,282,834)	(\$480,347)	(\$38,715)	2.7	33.1	\$802,487	\$1,244,119
CZ12-2	SMUD	-100,080	10403	33.24	-9%	(\$1,282,834)	(\$23,362)	(\$38,715)	54.9	33.1	\$1,259,472	\$1,244,119
CZ13	PG&E	-94,607	10029	32.47	-7%	(\$1,279,301)	(\$276,944)	\$244,552	4.6	>1	\$1,002,357	\$1,523,853
CZ14	SDG&E	-97,959	10056	31.91	-7%	(\$1,279,893)	(\$302,123)	(\$37,769)	4.2	33.9	\$977,770	\$1,242,124
CZ14-2	SCE	-97,959	10056	31.91	-7%	(\$1,279,893)	(\$129,082)	(\$37,769)	9.9	33.9	\$1,150,811	\$1,242,124
CZ15	SCE	-45,226	5579	20.17	0.04%	(\$1,276,847)	(\$6,533)	\$227	195.4	>1	\$1,270,314	\$1,277,074
CZ16	PG&E	-198,840	17599	47.73	-39%	(\$1,288,450)	(\$605,601)	(\$185,438)	2.1	6.9	\$682,848	\$1,103,011
CZ16-2	LADWP	-198,840	17599	47.73	-39%	(\$1,288,450)	\$40,268	(\$185,438)	>1	6.9	\$1,328,718	\$1,103,011



#### 4.4 Cost Effectiveness Results – PV-only and PV+Battery

The Reach Code Team ran packages of PV-only and PV+Battery measures, without any additional efficiency measures, to assess cost effectiveness on top of the mixed-fuel baseline building and the all-electric federal code minimum reference (Package 2 in Sections 4.1 – 4.3).

Jurisdictions interested in adopting PV-only reach codes should reference the mixed-fuel cost effectiveness results because a mixed-fuel building is the baseline for the nonresidential prototypes analyzed in this study. PV or PV+Battery packages are added to all-electric federal code minimum reference which (in many scenarios) do not have a positive compliance margin compared to the mixed-fuel baseline model, and are solely provided for informational purposes. Jurisdictions interested in reach codes requiring all-electric+PV or all-electric+PV+battery should reference package 3B results in Sections 4.1 – 4.3.<sup>25</sup>

Each of the following eight packages were evaluated against a mixed fuel baseline designed as per 2019 Title 24 Part 6 requirements.

- ◆ **Mixed-Fuel + 3 kW PV Only:**
- ◆ **Mixed-Fuel + 3 kW PV + 5 kWh battery**
- ◆ **Mixed-Fuel + PV Only:** PV sized per the roof size of the building, or to offset the annual electricity consumption, whichever is smaller
- ◆ **Mixed-Fuel + PV + 50 kWh Battery:** PV sized per the roof size of the building, or to offset the annual electricity consumption, whichever is smaller, along with 50 kWh battery
- ◆ **All-Electric + 3 kW PV Only**
- ◆ **All-Electric + 3 kW PV + 5 kWh Battery**
- ◆ **All-Electric + PV Only:** PV sized per the roof size of the building, or to offset the annual electricity consumption, whichever is smaller
- ◆ **All-Electric + PV + 50 kWh Battery:** PV sized per the roof size of the building, or to offset the annual electricity consumption, whichever is smaller, along with 50 kWh battery

Figure 38 through Figure 40 summarize the on-bill and TDV B/C ratios for each prototype for the two PV only packages and the two PV plus battery packages. Compliance margins are 0 percent for all mixed-fuel packages. For all-electric packages, compliance margins are equal to those found in Package 2 for each prototype in Sections 4.1 – 4.3. The compliance margins are not impacted by renewables and battery storage measures and hence not shown in the tables. These figures are formatted in the following way:

- ◆ Cells highlighted in green have a B/C ratio greater than 1 and are cost-effective. The shade of green gets darker as cost effectiveness increases.
- ◆ Cells not highlighted have a B/C ratio less than one and are not cost effective.

---

<sup>25</sup> Because this study shows that the addition of battery generally reduces cost effectiveness, removing a battery measure would only increase cost effectiveness. Thus, a jurisdiction can apply the EE+PV+Battery cost effectiveness findings to support EE+PV reach codes, because EE+PV would still remain cost effective without a battery.

Please see Appendix 6.7 for results in full detail. Generally, for mixed-fuel packages across all prototypes, all climate zones were proven to have cost effective outcomes using TDV except in CZ1 with a 3 kW PV + 5 kWh Battery scenario. Most climate zones also had On-Bill cost effectiveness. The addition of a battery slightly reduces cost effectiveness.

In all-electric packages, the results for most climate zones were found cost effective using both TDV and On-Bill approaches with larger PV systems or PV+Battery systems. Most 3 kW PV systems were also found to be cost effective except in some scenarios analyzing the Medium Office using the On-Bill method. CZ16 results continue to show challenges being cost effective with all electric buildings, likely due to the high heating loads in this climate. The addition of a battery slightly reduces the cost effectiveness for all-electric buildings with PV.



Figure 38. Cost Effectiveness for Medium Office - PV and Battery

CZ	PV Battery Utility	Mixed Fuel								All-Electric							
		3kW		3kW		135kW		135kW		3kW		3kW		135kW		135kW	
		0		5kWh		0		50kWh		0		5kWh		0		50kWh	
		On-Bill	TDV	On-Bill	TDV	On-Bill	TDV	On-Bill	TDV	On-Bill	TDV	On-Bill	TDV	On-Bill	TDV	On-Bill	TDV
CZ01	PG&E	2.8	1.5	1.7	0.9	1.7	1.3	1.6	1.2	0.9	1.6	0.9	1.6	2.5	2.0	2.1	1.7
CZ02	PG&E	3.7	1.9	2.1	1.1	2.2	1.6	2.0	1.4	0.8	2.2	0.9	2.6	3.2	2.4	2.7	2.1
CZ03	PG&E	3.7	1.8	2.2	1.0	2.1	1.5	1.9	1.4	1.9	3.9	2.0	4.0	3.4	2.5	2.9	2.2
CZ04	PG&E	3.6	2.0	2.1	1.2	2.3	1.6	2.1	1.5	0.9	2.1	1.1	2.7	3.3	2.5	2.9	2.2
CZ04-2	CPAU	2.1	2.0	1.3	1.2	1.8	1.6	1.6	1.5	7.7	2.1	9.8	2.7	2.9	2.5	2.5	2.2
CZ05	PG&E	4.2	1.9	2.4	1.1	2.5	1.6	2.3	1.5	1.8	2.7	1.9	2.7	4.0	2.7	3.4	2.3
CZ05-2	SCG	4.2	1.9	2.4	1.1	2.5	1.6	2.3	1.5	>1	>1	>1	>1	>1	3.0	9.4	2.6
CZ06	SCE	2.0	2.0	1.2	1.1	1.3	1.6	1.2	1.5	>1	7.2	>1	8.2	2.4	2.7	2.1	2.3
CZ06-2	LA	1.2	2.0	0.7	1.1	0.8	1.6	0.7	1.5	>1	7.2	>1	8.2	1.5	2.7	1.3	2.3
CZ07	SDG&E	3.2	2.0	1.9	1.2	2.1	1.6	1.9	1.5	>1	>1	>1	>1	3.7	2.7	3.2	2.3
CZ08	SCE	1.9	2.0	1.1	1.2	1.3	1.7	1.2	1.5	>1	>1	>1	>1	2.2	2.7	1.9	2.4
CZ08-2	LA	1.2	2.0	0.7	1.2	0.7	1.7	0.7	1.5	>1	>1	>1	>1	1.3	2.7	1.1	2.4
CZ09	SCE	1.9	2.0	1.1	1.2	1.3	1.7	1.2	1.5	>1	>1	>1	>1	2.2	2.6	1.9	2.3
CZ09-2	LA	1.1	2.0	0.7	1.2	0.7	1.7	0.7	1.5	>1	>1	>1	>1	1.3	2.6	1.2	2.3
CZ10	SDG&E	3.8	1.9	2.2	1.1	2.1	1.6	1.9	1.5	>1	3.3	>1	6.3	3.3	2.3	2.9	2.0
CZ10-2	SCE	2.1	1.9	1.2	1.1	1.3	1.6	1.2	1.5	>1	3.3	>1	6.3	2.0	2.3	1.8	2.0
CZ11	PG&E	3.6	1.9	2.1	1.1	2.2	1.6	2.0	1.5	1.1	2.6	1.5	3.6	3.2	2.4	2.8	2.1
CZ12	PG&E	3.5	1.9	2.1	1.1	2.2	1.6	2.0	1.5	0.9	2.5	1.2	3.2	3.1	2.4	2.7	2.1
CZ12-2	SMUD	1.4	1.9	0.8	1.1	1.1	1.6	1.04	1.5	>1	2.5	>1	3.2	1.9	2.4	1.6	2.1
CZ13	PG&E	3.5	1.8	2.0	1.1	2.2	1.5	2.0	1.4	1.1	2.5	1.5	3.6	3.1	2.3	2.7	2.0
CZ14	SDG&E	3.4	2.3	2.0	1.3	2.2	1.9	2.0	1.7	>1	2.3	>1	3.1	3.6	2.8	3.2	2.5
CZ14-2	SCE	1.9	2.3	1.1	1.3	1.3	1.9	1.2	1.7	>1	2.3	>1	3.1	2.2	2.8	1.9	2.5
CZ15	SCE	1.8	2.1	1.1	1.2	1.2	1.7	1.1	1.6	>1	7.5	>1	>1	1.8	2.4	1.6	2.1
CZ16	PG&E	3.9	2.0	2.3	1.1	2.3	1.6	2.1	1.5	0.3	0.4	0.4	0.6	2.5	1.8	2.2	1.6
CZ16-2	LA	1.2	2.0	0.7	1.1	0.7	1.6	0.7	1.5	>1	0.4	>1	0.6	1.3	1.8	1.2	1.6



Figure 39. Cost Effectiveness for Medium Retail - PV and Battery

CZ	Utility	Mixed Fuel								All-Electric							
		3kW		3kW		90 kW		90 kW		3kW		3kW		90 kW		90 kW	
		0		5kWh		0		50kWh		0		5kWh		0		50kWh	
		On-Bill	TDV	On-Bill	TDV	On-Bill	TDV	On-Bill	TDV	On-Bill	TDV	On-Bill	TDV	On-Bill	TDV	On-Bill	TDV
CZ01	PG&E	2.3	1.5	1.3	0.9	1.8	1.3	1.6	1.2	>1	3.0	>1	2.7	2.5	1.6	2.2	1.5
CZ02	PG&E	3.2	1.8	1.9	1.1	1.9	1.5	1.8	1.5	>1	>1	>1	>1	2.7	2.1	2.3	1.9
CZ03	PG&E	2.7	1.8	1.6	1.1	2.2	1.5	2.0	1.4	>1	>1	>1	>1	3.0	2.1	2.6	1.9
CZ04	PG&E	3.3	1.9	1.9	1.1	2.0	1.6	1.9	1.5	>1	>1	>1	>1	2.7	2.1	2.5	2.0
CZ04-2	CPAU	2.1	1.9	1.2	1.1	1.7	1.6	1.5	1.5	>1	>1	>1	>1	2.4	2.1	2.1	2.0
CZ05	PG&E	2.8	1.9	1.6	1.1	2.3	1.6	2.0	1.5	>1	>1	>1	>1	3.2	2.1	2.7	2.0
CZ05-2	SCG	2.8	1.9	1.6	1.1	2.3	1.6	2.0	1.5	>1	>1	>1	>1	3.7	1.9	3.2	1.6
CZ06	SCE	2.0	1.9	1.2	1.1	1.2	1.6	1.1	1.5	>1	>1	>1	>1	1.7	2.2	1.5	2.0
CZ06-2	LA	1.3	1.9	0.7	1.1	0.7	1.6	0.6	1.5	>1	>1	>1	>1	1.01	2.2	0.9	2.0
CZ07	SDG&E	4.0	2.0	2.4	1.2	1.5	1.6	1.6	1.6	>1	>1	>1	>1	2.4	2.3	2.3	2.1
CZ08	SCE	2.1	2.0	1.2	1.2	1.2	1.7	1.1	1.6	>1	>1	>1	>1	1.7	2.4	1.5	2.1
CZ08-2	LA	1.3	2.0	0.8	1.2	0.7	1.7	0.6	1.6	>1	>1	>1	>1	1.01	2.4	0.9	2.1
CZ09	SCE	2.0	2.0	1.2	1.2	1.2	1.7	1.1	1.5	>1	>1	>1	>1	1.8	2.4	1.6	2.1
CZ09-2	LA	1.2	2.0	0.7	1.2	0.7	1.7	0.7	1.5	>1	>1	>1	>1	1.1	2.4	0.99	2.1
CZ10	SDG&E	3.8	2.0	2.2	1.2	1.7	1.6	1.7	1.5	>1	>1	>1	>1	2.6	2.3	2.5	2.0
CZ10-2	SCE	2.0	2.0	1.2	1.2	1.2	1.6	1.1	1.5	>1	>1	>1	>1	1.8	2.3	1.6	2.0
CZ11	PG&E	2.8	1.9	1.6	1.1	1.9	1.6	1.8	1.5	>1	>1	>1	>1	2.7	2.3	2.5	2.1
CZ12	PG&E	3.0	1.9	1.7	1.1	1.9	1.6	1.8	1.5	>1	>1	>1	>1	2.7	2.3	2.5	2.1
CZ12-2	SMUD	1.5	1.9	0.9	1.1	1.1	1.6	0.997	1.5	>1	>1	>1	>1	1.7	2.3	1.4	2.1
CZ13	PG&E	3.0	1.9	1.7	1.1	1.9	1.6	1.8	1.4	>1	>1	>1	>1	2.7	2.2	2.4	1.9
CZ14	SDG&E	3.5	2.2	2.1	1.3	1.6	1.8	1.5	1.6	>1	>1	>1	>1	2.5	2.6	2.2	2.2
CZ14-2	SCE	1.8	2.2	1.1	1.3	1.2	1.8	1.1	1.6	>1	>1	>1	>1	1.7	2.6	1.5	2.2
CZ15	SCE	1.9	2.0	1.1	1.2	1.1	1.7	1.02	1.5	>1	>1	>1	>1	1.7	2.4	1.5	2.1
CZ16	PG&E	3.7	2.0	2.1	1.2	2.1	1.7	1.9	1.6	0.6	0.5	0.5	0.4	2.7	2.0	2.3	1.8
CZ16-2	LA	1.3	2.0	0.7	1.2	0.7	1.7	0.6	1.6	>1	0.5	>1	0.4	1.2	2.0	1.0	1.8





Figure 40. Cost Effectiveness for Small Hotel - PV and Battery

CZ	Utility	Mixed Fuel								All-Electric							
		3kW		3kW		80kW		80kW		3kW		3kW		80kW		80kW	
		0		5kWh		0		50kWh		0		5kWh		0		50kWh	
		On-Bill	TDV	On-Bill	TDV	On-Bill	TDV	On-Bill	TDV	On-Bill	TDV	On-Bill	TDV	On-Bill	TDV	On-Bill	TDV
CZ01	PG&E	2.3	1.5	1.3	0.9	1.9	1.2	1.6	1.1	2.3	>1	2.3	>1	4.8	>1	4.7	>1
CZ02	PG&E	2.3	1.9	1.3	1.1	1.8	1.5	1.6	1.4	5.6	>1	5.6	>1	>1	>1	>1	>1
CZ03	PG&E	2.7	1.8	1.6	1.05	2.3	1.5	1.9	1.4	4.2	>1	4.2	>1	>1	>1	>1	>1
CZ04	PG&E	2.4	1.9	1.4	1.1	1.8	1.6	1.6	1.5	6.2	>1	6.2	>1	>1	>1	>1	>1
CZ04-2	CPAU	2.1	1.9	1.2	1.1	1.7	1.6	1.5	1.5	>1	>1	>1	>1	>1	>1	>1	>1
CZ05	PG&E	2.9	1.9	1.7	1.1	2.4	1.6	2.0	1.5	3.9	>1	3.9	>1	>1	>1	>1	>1
CZ05-2	SCG	2.9	1.9	1.7	1.1	2.4	1.6	2.0	1.5	>1	>1	>1	>1	>1	>1	>1	>1
CZ06	SCE	1.8	1.9	1.1	1.1	1.1	1.6	0.9	1.4	>1	>1	>1	>1	>1	>1	>1	>1
CZ06-2	LA	1.1	1.9	0.7	1.1	0.7	1.6	0.6	1.4	>1	>1	>1	>1	>1	>1	>1	>1
CZ07	SDG&E	2.6	2.0	1.5	1.1	1.4	1.6	1.3	1.5	>1	>1	>1	>1	>1	>1	>1	>1
CZ08	SCE	1.9	2.0	1.1	1.2	1.2	1.7	1.0	1.5	>1	>1	>1	>1	>1	>1	>1	>1
CZ08-2	LA	1.2	2.0	0.7	1.2	0.7	1.7	0.6	1.5	>1	>1	>1	>1	>1	>1	>1	>1
CZ09	SCE	1.9	1.9	1.1	1.1	1.2	1.6	0.997	1.4	>1	>1	>1	>1	>1	>1	>1	>1
CZ09-2	LA	1.1	1.9	0.7	1.1	0.7	1.6	0.6	1.4	>1	>1	>1	>1	>1	>1	>1	>1
CZ10	SDG&E	2.9	1.9	1.7	1.1	1.5	1.6	1.4	1.4	8.2	>1	8.2	>1	>1	>1	>1	>1
CZ10-2	SCE	1.7	1.9	0.99	1.1	1.2	1.6	0.99	1.4	>1	>1	>1	>1	>1	>1	>1	>1
CZ11	PG&E	2.6	1.9	1.5	1.1	1.8	1.6	1.5	1.4	7.6	>1	7.6	>1	>1	>1	>1	>1
CZ12	PG&E	2.7	1.9	1.6	1.1	2.3	1.6	1.9	1.4	4.0	>1	4.0	>1	>1	>1	>1	>1
CZ12-2	SMUD	1.4	1.9	0.8	1.1	1.1	1.6	0.95	1.4	>1	>1	>1	>1	>1	>1	>1	>1
CZ13	PG&E	2.6	1.8	1.5	1.1	1.8	1.5	1.5	1.4	7.7	>1	7.7	>1	>1	>1	>1	>1
CZ14	SDG&E	3.0	2.2	1.7	1.3	1.7	1.8	1.5	1.6	4.2	>1	4.2	>1	>1	>1	>1	>1
CZ14-2	SCE	1.8	2.2	1.1	1.3	1.3	1.8	1.1	1.6	>1	>1	>1	>1	>1	>1	>1	>1
CZ15	SCE	1.7	2.0	1.002	1.2	1.2	1.7	1.003	1.4	>1	>1	>1	>1	>1	>1	>1	>1
CZ16	PG&E	2.7	2.0	1.6	1.2	1.9	1.6	1.7	1.5	2.1	5.7	2.1	5.6	5.8	>1	5.8	>1
CZ16-2	LA	1.02	2.0	0.6	1.2	0.6	1.6	0.6	1.5	>1	5.7	>1	5.6	>1	>1	>1	>1



## 5 Summary, Conclusions, and Further Considerations

The Reach Codes Team developed packages of energy efficiency measures as well as packages combining energy efficiency with PV generation and battery storage systems, simulated them in building modeling software, and gathered costs to determine the cost effectiveness of multiple scenarios. The Reach Codes team coordinated assumptions with multiple utilities, cities, and building community experts to develop a set of assumptions considered reasonable in the current market. Changing assumptions, such as the period of analysis, measure selection, cost assumptions, energy escalation rates, or utility tariffs are likely to change results.

### 5.1 Summary

Figure 41 through Figure 43 summarize results for each prototype and depict the compliance margins achieved for each climate zone and package. Because local reach codes must both exceed the Energy Commission performance budget (i.e., have a positive compliance margin) and be cost-effective, the Reach Code Team highlighted cells meeting these two requirements to help clarify the upper boundary for potential reach code policies:

- ◆ Cells highlighted in green depict a positive compliance margin and cost-effective results using both On-Bill and TDV approaches.
- ◆ Cells highlighted in yellow depict a positive compliance and cost-effective results using either the On-Bill or TDV approach.
- ◆ Cells not highlighted either depict a negative compliance margin or a package that was not cost effective using either the On-Bill or TDV approach.

For more detail on the results in the Figures, please refer to *Section 4 Results*. As described in Section 4.4, PV-only and PV+Battery packages in the mixed-fuel building were found to be cost effective across all prototypes, climate zones, and packages using the TDV approach, and results are not reiterated in the following figures.



**Figure 41. Medium Office Summary of Compliance Margin and Cost Effectiveness**

CZ	Utility	Mixed Fuel			All Electric			
		EE	EE + PV + B	HE	Fed Code	EE	EE + PV + B	HE
CZ01	PG&E	18%	18%	3%	-15%	7%	7%	-14%
CZ02	PG&E	17%	17%	4%	-7%	10%	10%	-5%
CZ03	PG&E	20%	20%	3%	-7%	16%	16%	-6%
CZ04	PG&E	14%	14%	5%	-6%	9%	9%	-3%
CZ04-2	CPAU	14%	14%	5%	-6%	9%	9%	-3%
CZ05	PG&E	18%	18%	4%	-8%	12%	12%	-6%
CZ05-2	SCG	18%	18%	4%	NA	NA	NA	NA
CZ06	SCE	20%	20%	3%	-4%	18%	18%	-2%
CZ06-2	LADWP	20%	20%	3%	-4%	18%	18%	-2%
CZ07	SDG&E	20%	20%	4%	-2%	20%	20%	1%
CZ08	SCE	18%	18%	4%	-2%	18%	18%	1%
CZ08-2	LADWP	18%	18%	4%	-2%	18%	18%	1%
CZ09	SCE	16%	16%	4%	-2%	15%	15%	2%
CZ09-2	LADWP	16%	16%	4%	-2%	15%	15%	2%
CZ10	SDG&E	17%	17%	4%	-4%	13%	13%	-1%
CZ10-2	SCE	17%	17%	4%	-4%	13%	13%	-1%
CZ11	PG&E	13%	13%	5%	-4%	10%	10%	0%
CZ12	PG&E	14%	14%	5%	-5%	10%	10%	-1%
CZ12-2	SMUD	14%	14%	5%	-5%	10%	10%	-1%
CZ13	PG&E	13%	13%	5%	-4%	9%	9%	0%
CZ14	SDG&E	14%	14%	5%	-5%	9%	9%	-1%
CZ14-2	SCE	14%	14%	5%	-5%	9%	9%	-1%
CZ15	SCE	12%	12%	5%	-2%	10%	10%	3%
CZ16	PG&E	14%	14%	5%	-27%	-15%	-15%	-26%
CZ16-2	LADWP	14%	14%	5%	-27%	-15%	-15%	-26%



**Figure 42. Medium Retail Summary of Compliance Margin and Cost Effectiveness**

CZ	Utility	Mixed Fuel			Fed Code	All Electric		
		EE	EE + PV + B	HE		EE	EE + PV + B	HE
CZ01	PG&E	18%	18%	2%	-4.1%	15%	15%	-2%
CZ02	PG&E	13%	13%	3%	-1.0%	13%	13%	3%
CZ03	PG&E	16%	16%	2%	-0.4%	16%	16%	2%
CZ04	PG&E	14%	14%	3%	-0.1%	14%	14%	3%
CZ04-2	CPAU	14%	14%	3%	-0.1%	14%	14%	3%
CZ05	PG&E	16%	16%	1%	-1.2%	15%	15%	1%
CZ05-2	SCG	16%	16%	1%	NA	NA	NA	NA
CZ06	SCE	10%	10%	3%	0.5%	11%	11%	3%
CZ06-2	LADWP	10%	10%	3%	0.5%	11%	11%	3%
CZ07	SDG&E	13%	13%	2%	0.3%	13%	13%	3%
CZ08	SCE	10%	10%	3%	0.4%	10%	10%	4%
CZ08-2	LADWP	10%	10%	3%	0.4%	10%	10%	4%
CZ09	SCE	10%	10%	4%	0.4%	10%	10%	4%
CZ09-2	LADWP	10%	10%	4%	0.4%	10%	10%	4%
CZ10	SDG&E	12%	12%	4%	0.1%	12%	12%	4%
CZ10-2	SCE	12%	12%	4%	0.1%	12%	12%	4%
CZ11	PG&E	13%	13%	4%	0.5%	12%	12%	5%
CZ12	PG&E	13%	13%	4%	-0.1%	12%	12%	4%
CZ12-2	SMUD	13%	13%	4%	-0.1%	12%	12%	4%
CZ13	PG&E	15%	15%	4%	-0.4%	14%	14%	4%
CZ14	SDG&E	13%	13%	4%	0.7%	15%	15%	5%
CZ14-2	SCE	13%	13%	4%	0.7%	15%	15%	5%
CZ15	SCE	12%	12%	5%	0.9%	12%	12%	6%
CZ16	PG&E	13%	13%	3%	-12.2%	3%	3%	-8%
CZ16-2	LADWP	13%	13%	3%	-12.2%	3%	3%	-8%



**Figure 43. Small Hotel Summary of Compliance Margin and Cost Effectiveness**

CZ	Utility	Mixed Fuel			All Electric			
		EE	EE + PV + B	HE	Fed Code	EE	EE + PV + B	HE
CZ01	PG&E	9%	9%	2%	-28%	1%	1%	-24%
CZ02	PG&E	7%	7%	3%	-12%	4%	4%	-11%
CZ03	PG&E	10%	10%	2%	-14%	6%	6%	-14%
CZ04	PG&E	6%	6%	2%	-13%	0.2%	0.2%	-13%
CZ04-2	CPAU	6%	6%	2%	-13%	0.2%	0.2%	-13%
CZ05	PG&E	9%	9%	2%	-15%	5%	5%	-15%
CZ05-2	SCG	9%	9%	2%	NA	NA	NA	NA
CZ06	SCE	8%	8%	2%	-5%	7%	7%	-15%
CZ06-2	LADWP	8%	8%	2%	-5%	7%	7%	-15%
CZ07	SDG&E	8%	8%	2%	-7%	7%	7%	-7%
CZ08	SCE	7%	7%	2%	-6%	3%	3%	-6%
CZ08-2	LADWP	7%	7%	2%	-6%	3%	3%	-6%
CZ09	SCE	6%	6%	3%	-6%	2%	2%	-4%
CZ09-2	LADWP	6%	6%	3%	-6%	2%	2%	-4%
CZ10	SDG&E	5%	5%	4%	-8%	2%	2%	-5%
CZ10-2	SCE	5%	5%	4%	-8%	2%	2%	-5%
CZ11	PG&E	4%	4%	4%	-10%	1%	1%	-7%
CZ12	PG&E	5%	5%	4%	-10%	2%	2%	-9%
CZ12-2	SMUD	5%	5%	4%	-10%	2%	2%	-9%
CZ13	PG&E	4%	4%	3%	-10%	0.3%	0.3%	-7%
CZ14	SDG&E	4%	4%	4%	-11%	0.1%	0.1%	-7%
CZ14-2	SCE	4%	4%	4%	-11%	0.1%	0.1%	-7%
CZ15	SCE	3%	3%	5%	-4%	2%	2%	0.04%
CZ16	PG&E	6%	6%	3%	-50%	-14%	-14%	-39%
CZ16-2	LADWP	6%	6%	3%	-50%	-14%	-14%	-39%

## 5.2 Conclusions and Further Considerations

Findings are specific to the scenarios analyzed under this specific methodology, and largely pertain to office, retail, and hotel-type occupancies. Nonresidential buildings constitute a wide variety of occupancy profiles and process loads, making findings challenging to generalize across multiple building types.

Findings indicate the following overall conclusions:

1. This study assumed that electrifying space heating and service water heating could eliminate natural gas infrastructure alone, because these were the only gas end-uses included the prototypes. Avoiding the installation of natural gas infrastructure results in significant cost savings and is a primary factor toward cost-effective outcomes in all-electric designs, even with necessary increases in electrical capacity.
2. There is ample opportunity for cost effective energy efficiency improvements, as demonstrated by the compliance margins achieved in many of the efficiency-only and efficiency + PV packages. Though much of the energy savings are attributable to lighting measures, efficiency measures selected for these prototypes are confined to the building systems that can be modeled. There is



likely further opportunity for energy savings through measures that cannot be currently demonstrated in compliance software, such as high-performance control sequences or variable speed parallel fan powered boxes.

3. High efficiency appliances triggering federal preemption do not achieve as high compliance margins as the other efficiency measures analyzed in this study. Cost effectiveness appears to be dependent on the system type and building type. Nonetheless, specifying high efficiency equipment will always be a key feature in integrated design.
4. Regarding the Small Hotel prototype:
  - a. The Small Hotel presents a challenging prototype to cost-effectively exceed the state's energy performance budget without efficiency measures. The Reach Code Team is uncertain of the precision of the results due to the inability to directly model either drain water heat recovery or a central heat pump water heater with a recirculation loop.
  - b. Hotel results may be applicable to high-rise (4 or more stories) multifamily buildings. Both hotel and multifamily buildings have the same or similar mandatory and prescriptive compliance options for hot water systems, lighting, and envelope. Furthermore, the Alternate Calculation Method Reference Manual specifies the same baseline HVAC system for both building types.
  - c. Hotel compliance margins were the lowest among the three building types analyzed, and thus the most conservative performance thresholds applicable to other nonresidential buildings not analyzed in this study. As stated previously, the varying occupancy and energy profiles of nonresidential buildings makes challenging to directly apply these results across all buildings.
5. Many all-electric and solar PV packages demonstrated greater GHG reductions than their mixed-fuel counterparts, contrary to TDV-based performance, suggesting a misalignment among the TDV metric and California's long-term GHG-reduction goals. The Energy Commission has indicated that they are aware of this issue and are seeking to address it.
6. Changes to the Nonresidential Alternative Calculation Method (ACM) Reference Manual can drastically impact results. Two examples include:
  - a. When performance modeling residential buildings, the Standard Design is electric if the Proposed Design is electric, which removes TDV-related penalties and associated negative compliance margins. This essentially allows for a compliance pathway for all-electric residential buildings. If nonresidential buildings were treated in the same way, all-electric cost effectiveness using the TDV approach would improve.
  - b. The baseline mixed-fuel system for a hotel includes a furnace in each guest room, which carries substantial plumbing costs and labor costs for assembly. A change in the baseline system would lead to different base case costs and different cost effectiveness outcomes.
7. All-electric federal code-minimum packages appear to be cost effective, largely due to avoided natural gas infrastructure, but in most cases do not comply with the Energy Commission's minimum performance budget (as described in item 7a above). For most cases it appears that adding cost-effective efficiency measures achieves compliance. All-electric nonresidential projects can leverage the initial cost savings of avoiding natural gas infrastructure by adding energy efficiency measures that would not be cost effective independently.



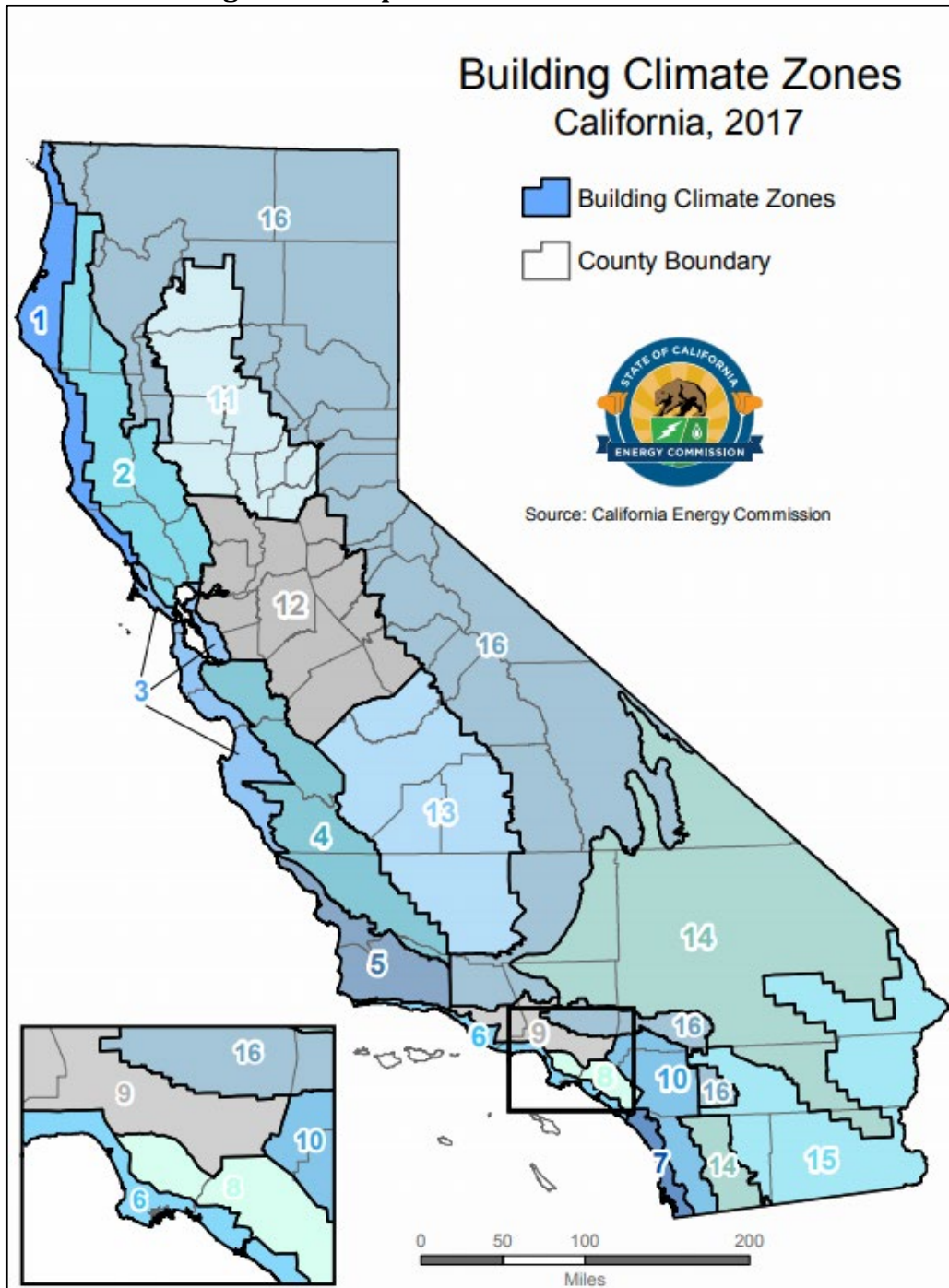
## 6 Appendices

### 6.1 Map of California Climate Zones

Climate zone geographical boundaries are depicted in Figure 44. The map in Figure 44 along with a zip-code search directory is available at:

[https://ww2.energy.ca.gov/maps/renewable/building\\_climate\\_zones.html](https://ww2.energy.ca.gov/maps/renewable/building_climate_zones.html)

**Figure 44. Map of California Climate Zones**



### 6.2 Lighting Efficiency Measures

Figure 45 details the applicability and impact of each lighting efficiency measure by prototype and space function and includes the resulting LPD that is modeled as the proposed by building type and by space function.

**Figure 45. Impact of Lighting Measures on Proposed LPDs by Space Function**

Space Function	Baseline	Impact				Modeled Proposed
	LPD (W/ft <sup>2</sup> )	Interior Lighting Reduced LPD	Institutional Tuning	Daylight Dimming Plus OFF	Occupant Sensing in Open Office Plan	LPD (W/ft <sup>2</sup> )
Medium Office						
Office Area (Open plan office) - Interior	0.65	15%	10%	-	17%	0.429
Office Area (Open plan office) - Perimeter	0.65	15%	5%	10%	30%	0.368
Medium Retail						
Commercial/Industrial Storage (Warehouse)	0.45	10%	5%	-	-	0.386
Main Entry Lobby	0.85	10%	5%	-	-	0.729
Retail Sales Area (Retail Merchandise Sales)	0.95	5%	5%	-	-	0.857
Small Hotel						
Commercial/Industrial Storage (Warehouse)	0.45	10%	5%	-	-	0.386
Convention, Conference, Multipurpose, and Meeting	0.85	10%	5%	-	-	0.729
Corridor Area	0.60	10%	5%	-	-	0.514
Exercise/Fitness Center and Gymnasium Areas	0.50	10%	-	-	-	0.450
Laundry Area	0.45	10%	-	-	-	0.405
Lounge, Breakroom, or Waiting Area	0.65	10%	5%	-	-	0.557
Mechanical	0.40	10%	-	-	-	0.360
Office Area (>250 ft <sup>2</sup> )	0.65	10%	5%	-	-	0.557

### 6.3 Drain Water Heat Recovery Measure Analysis

To support potential DWHR savings in the Small Hotel prototype, the Reach Code Team modeled the drain water heat recovery measure in CBECC-Res 2019 in the all-electric and mixed fuel 6,960 ft<sup>2</sup> prototype residential buildings. The Reach Code Team assumed one heat recovery device for every three showers assuming unequal flow to the shower. Based on specifications from three different drain water heat recovery device manufacturers for device effectiveness in hotel applications, the team assumed a heat recovery efficiency of 50 percent.

The Reach Code Team modeled mixed fuel and all-electric residential prototype buildings both with and without heat recovery in each climate zone. Based on these model results, the Reach Code Team determined the percentage savings of domestic water heating energy in terms of gas, electricity, and TDV for mixed fuel and all-electric, in each climate zone. The Reach Code Team then applied the savings





percentages to the Small Hotel prototype domestic water heating energy in both the mixed-fuel and all-electric to determine energy savings for the drain water heat recovery measure in the Small Hotel. The Reach Code Team applied volumetric energy rates to estimate on-bill cost impacts from this measure.

### 6.4 Utility Rate Schedules

The Reach Codes Team used the IOU and POU rates depicted in Figure 46 to determine the On-Bill savings for each prototype.

**Figure 46. Utility Tariffs Analyzed Based on Climate Zone – Detailed View**

Climate Zones	Electric / Gas Utility	Electricity (Time-of-use)			Natural Gas
		Medium Office	Medium Retail	Small Hotel	All Prototypes
CZ01	PG&E	A-10	A-1	A-1 or A-10	G-NR1
CZ02	PG&E	A-10	A-10	A-1 or A-10	G-NR1
CZ03	PG&E	A-10	A-1 or A-10	A-1 or A-10	G-NR1
CZ04	PG&E	A-10	A-10	A-1 or A-10	G-NR1
CZ04-2	CPAU/PG&E	E-2	E-2	E-2	G-NR1
CZ05	PG&E	A-10	A-1	A-1 or A-10	G-NR1
CZ05-2	PG&E/SCG	A-10	A-1	A-1 or A-10	G-10 (GN-10)
CZ06	SCE/SCG	TOU-GS-2	TOU-GS-2	TOU-GS-2 or TOU-GS-3	G-10 (GN-10)
CZ06	LADWP/SCG	TOU-GS-2	TOU-GS-2	TOU-GS-2 or TOU-GS-3	G-10 (GN-10)
CZ07	SDG&E	AL-TOU+EECC (AL-TOU)	AL-TOU+EECC (AL-TOU)	AL-TOU+EECC (AL-TOU)	GN-3
CZ08	SCE/SCG	TOU-GS-2	TOU-GS-2	TOU-GS-2 or TOU-GS-3	G-10 (GN-10)
CZ08-2	LADWP/SCG	A-2 (B)	A-2 (B)	A-2 (B)	G-10 (GN-10)
CZ09	SCE/SCG	TOU-GS-2	TOU-GS-2	TOU-GS-2 or TOU-GS-3	G-10 (GN-10)
CZ09-2	LADWP/SCG	A-2 (B)	A-2 (B)	A-2 (B)	G-10 (GN-10)
CZ10	SCE/SCG	TOU-GS-2	TOU-GS-2	TOU-GS-2	G-10 (GN-10)
CZ10-2	SDG&E	AL-TOU+EECC (AL-TOU)	AL-TOU+EECC (AL-TOU)	AL-TOU+EECC (AL-TOU)	GN-3
CZ11	PG&E	A-10	A-10	A-10	G-NR1
CZ12	PG&E	A-10	A-10	A-1 or A-10	G-NR1
CZ12-2	SMUD/PG&E	GS	GS	GS	G-NR1
CZ13	PG&E	A-10	A-10	A-10	G-NR1
CZ14	SCE/SCG	TOU-GS-3	TOU-GS-3	TOU-GS-3	G-10 (GN-10)
CZ14-2	SDG&E	AL-TOU+EECC (AL-TOU)	AL-TOU+EECC (AL-TOU)	AL-TOU+EECC (AL-TOU)	GN-3
CZ15	SCE/SCG	TOU-GS-3	TOU-GS-2	TOU-GS-2	G-10 (GN-10)
CZ16	PG&E	A-10	A-10	A-1 or A-10	G-NR1
CZ16-2	LADWP/SCG	A-2 (B)	A-2 (B)	A-2 (B)	G-10 (GN-10)



### 6.5 Mixed Fuel Baseline Energy Figures

Figures 47 to 49 show the annual electricity and natural gas consumption and cost, compliance TDV, and GHG emissions for each prototype under the mixed fuel design baseline.

**Figure 47. Medium Office – Mixed Fuel Baseline**

Climate Zone	Utility	Electricity Consumption (kWh)	Natural Gas Consumption (Therms)	Electricity Cost	Natural Gas Cost	Compliance TDV	GHG Emissions (lbs)
<b>Medium Office Mixed Fuel Baseline</b>							
CZ01	PG&E	358,455	4,967	\$109,507	\$6,506	84	266,893
CZ02	PG&E	404,865	3,868	\$130,575	\$5,256	122	282,762
CZ03	PG&E	370,147	3,142	\$116,478	\$4,349	88	251,759
CZ04	PG&E	431,722	3,759	\$140,916	\$5,144	141	299,993
CZ04-2	CPAU	431,722	3,759	\$75,363	\$5,144	141	299,993
CZ05	PG&E	400,750	3,240	\$131,277	\$4,481	106	269,768
CZ05-2	SCG	400,750	3,240	\$131,277	\$3,683	106	269,768
CZ06	SCE	397,441	2,117	\$74,516	\$2,718	105	253,571
CZ06-2	LA	397,441	2,117	\$44,311	\$2,718	105	253,571
CZ07	SDG&E	422,130	950	\$164,991	\$4,429	118	257,324
CZ08	SCE	431,207	1,219	\$79,181	\$1,820	132	265,179
CZ08-2	LA	431,207	1,219	\$46,750	\$1,820	132	265,179
CZ09	SCE	456,487	1,605	\$86,190	\$2,196	155	287,269
CZ09-2	LA	456,487	1,605	\$51,111	\$2,196	155	287,269
CZ10	SDG&E	431,337	2,053	\$173,713	\$5,390	130	272,289
CZ10-2	SCE	431,337	2,053	\$80,636	\$2,603	130	272,289
CZ11	PG&E	464,676	3,062	\$150,520	\$4,333	163	310,307
CZ12	PG&E	441,720	3,327	\$142,902	\$4,647	152	299,824
CZ12-2	SMUD	441,720	3,327	\$65,707	\$4,647	152	299,824
CZ13	PG&E	471,540	3,063	\$150,919	\$4,345	161	316,228
CZ14	SDG&E	467,320	3,266	\$185,812	\$6,448	165	314,258
CZ14-2	SCE	467,320	3,266	\$92,071	\$3,579	165	314,258
CZ15	SCE	559,655	1,537	\$105,388	\$2,058	211	347,545
CZ16	PG&E	405,269	6,185	\$127,201	\$8,056	116	312,684
CZ16-2	LA	405,269	6,185	\$43,115	\$8,056	116	312,684



**Figure 48. Medium Retail – Mixed Fuel Baseline**

Climate Zone	Utility	Electricity Consumption (kWh)	Natural Gas Consumption (Therms)	Electricity Cost	Natural Gas Cost	Compliance TDV	GHG Emissions (lbs)
<b>Medium Retail Mixed Fuel Baseline</b>							
CZ01	PG&E	184,234	3,893	\$43,188	\$5,247	155	156,972
CZ02	PG&E	214,022	2,448	\$70,420	\$3,572	202	157,236
CZ03	PG&E	199,827	1,868	\$47,032	\$2,871	165	140,558
CZ04	PG&E	208,704	1,706	\$66,980	\$2,681	187	143,966
CZ04-2	CPAU	208,704	1,706	\$36,037	\$2,681	187	143,966
CZ05	PG&E	195,864	1,746	\$45,983	\$2,697	155	135,849
CZ05-2	SCG	195,864	1,746	\$45,983	\$2,342	155	135,849
CZ06	SCE	211,123	1,002	\$36,585	\$1,591	183	135,557
CZ06-2	LA	211,123	1,002	\$21,341	\$1,591	183	135,557
CZ07	SDG&E	211,808	522	\$75,486	\$4,055	178	130,436
CZ08	SCE	212,141	793	\$36,758	\$1,373	190	133,999
CZ08-2	LA	212,141	793	\$21,436	\$1,373	190	133,999
CZ09	SCE	227,340	970	\$40,083	\$1,560	218	146,680
CZ09-2	LA	227,340	970	\$23,487	\$1,560	218	146,680
CZ10	SDG&E	235,465	1,262	\$87,730	\$4,700	228	154,572
CZ10-2	SCE	235,465	1,262	\$41,000	\$1,853	228	154,572
CZ11	PG&E	234,560	2,415	\$76,670	\$3,547	244	170,232
CZ12	PG&E	228,958	2,309	\$75,084	\$3,426	234	165,133
CZ12-2	SMUD	228,958	2,309	\$32,300	\$3,426	234	165,133
CZ13	PG&E	242,927	1,983	\$81,995	\$3,034	258	170,345
CZ14	SDG&E	264,589	1,672	\$97,581	\$5,059	277	178,507
CZ14-2	SCE	264,589	1,672	\$46,217	\$2,172	277	178,507
CZ15	SCE	290,060	518	\$50,299	\$1,083	300	179,423
CZ16	PG&E	212,204	4,304	\$67,684	\$5,815	197	180,630
CZ16-2	LA	212,204	4,304	\$20,783	\$5,815	197	180,630



**Figure 49. Small Hotel – Mixed Fuel Baseline**

Climate Zone	Utility	Electricity Consumption (kWh)	Natural Gas Consumption (Therms)	Electricity Cost	Natural Gas Cost	Compliance TDV	GHG Emissions (lbs)
<b>Small Hotel Mixed Fuel Baseline</b>							
CZ01	PG&E	177,734	16,936	40,778	20,465	110	340,491
CZ02	PG&E	189,319	12,696	53,396	15,664	110	293,056
CZ03	PG&E	183,772	12,341	42,325	15,210	98	284,217
CZ04	PG&E	187,482	11,945	52,118	14,806	106	281,851
CZ04-2	CPAU	187,482	11,945	32,176	14,806	106	281,851
CZ05	PG&E	187,150	11,979	43,182	14,733	98	281,183
CZ05-2	SCG	187,150	11,979	43,182	10,869	98	281,183
CZ06	SCE	191,764	8,931	28,036	8,437	98	244,664
CZ06-2	LA	191,764	8,931	16,636	8,437	98	244,664
CZ07	SDG&E	189,174	8,207	58,203	10,752	90	233,884
CZ08	SCE	190,503	8,372	27,823	7,991	94	236,544
CZ08-2	LA	190,503	8,372	16,555	7,991	94	236,544
CZ09	SCE	198,204	8,421	30,262	8,030	103	242,296
CZ09-2	LA	198,204	8,421	17,951	8,030	103	242,296
CZ10	SDG&E	215,364	8,437	71,713	10,926	122	255,622
CZ10-2	SCE	215,364	8,437	33,736	8,043	122	255,622
CZ11	PG&E	219,852	10,271	63,724	12,882	131	282,232
CZ12	PG&E	199,499	10,422	46,245	13,022	115	270,262
CZ12-2	SMUD	199,499	10,422	26,872	13,022	115	270,262
CZ13	PG&E	226,925	10,048	65,559	12,629	132	284,007
CZ14	SDG&E	226,104	10,075	73,621	12,167	134	283,287
CZ14-2	SCE	226,104	10,075	35,187	9,350	134	283,287
CZ15	SCE	280,595	5,598	42,852	5,777	152	260,378
CZ16	PG&E	191,231	17,618	51,644	21,581	127	358,590
CZ16-2	LA	191,231	17,618	16,029	21,581	127	358,590

**6.6 Hotel TDV Cost Effectiveness with Propane Baseline**

The Reach Codes Team further analyzed TDV cost effectiveness of the all-electric packages with a mixed-fuel design baseline using propane instead of natural gas. Results for each package are shown in Figure 50. through Figure 53. below.

All electric models compared to a propane baseline have positive compliance margins in all climate zones when compared to results using a natural gas baseline. Compliance margin improvement is roughly 30 percent, which also leads to improved cost effectiveness for the all-electric packages. These outcomes are likely due to the TDV penalty associated with propane when compared to natural gas.



Across packages, TDV cost effectiveness with a propane baseline follows similar trends as the natural gas baseline. Adding efficiency measures increased compliance margins by 3 to 10 percent depending on climate zone, while adding high efficiency HVAC and SHW equipment alone increased compliance margins by smaller margins of about 2 to 4 percent compared to the All-Electric package.

**Figure 50. TDV Cost Effectiveness for Small Hotel, Propane Baseline – Package 2 All-Electric Federal Code Minimum**

Climate Zone	Compliance Margin (%)	Incremental Package Cost	\$-TDV Savings	B/C Ratio (TDV)	NPV (TDV)
CZ01	-4%	(\$1,271,869)	(\$28,346)	44.9	\$1,243,523
CZ02	27%	(\$1,272,841)	\$170,263	>1	\$1,443,104
CZ03	-3%	(\$1,275,114)	(\$16,425)	77.6	\$1,258,689
CZ04	26%	(\$1,274,949)	\$155,466	>1	\$1,430,414
CZ05	27%	(\$1,275,002)	\$154,709	>1	\$1,429,710
CZ06	17%	(\$1,275,143)	\$126,212	>1	\$1,401,355
CZ07	25%	(\$1,273,490)	\$117,621	>1	\$1,391,111
CZ08	24%	(\$1,271,461)	\$122,087	>1	\$1,393,548
CZ09	23%	(\$1,273,259)	\$123,525	>1	\$1,396,784
CZ10	18%	(\$1,270,261)	\$109,522	>1	\$1,379,783
CZ11	19%	(\$1,271,070)	\$129,428	>1	\$1,400,498
CZ12	-4%	(\$1,272,510)	(\$26,302)	48.4	\$1,246,208
CZ13	18%	(\$1,270,882)	\$124,357	>1	\$1,395,239
CZ14	17%	(\$1,271,241)	\$117,621	>1	\$1,388,861
CZ15	-7%	(\$1,269,361)	(\$45,338)	28.0	\$1,224,023
CZ16	9%	(\$1,275,637)	\$68,272	>1	\$1,343,908



**Figure 51. TDV Cost Effectiveness for Small Hotel, Propane Baseline – Package 3A (All-Electric + EE)**

Climate Zone	Compliance Margin (%)	Incremental Package Cost	-\$-TDV Savings	B/C Ratio (TDV)	NPV (TDV)
CZ01	35%	(\$1,250,898)	\$252,831	>1	\$1,503,729
CZ02	34%	(\$1,251,870)	\$217,238	>1	\$1,469,108
CZ03	37%	(\$1,254,142)	\$218,642	>1	\$1,472,784
CZ04	31%	(\$1,250,769)	\$191,393	>1	\$1,442,162
CZ05	36%	(\$1,254,031)	\$208,773	>1	\$1,462,804
CZ06	25%	(\$1,250,964)	\$159,714	>1	\$1,410,677
CZ07	32%	(\$1,249,311)	\$154,111	>1	\$1,403,422
CZ08	29%	(\$1,247,282)	\$146,536	>1	\$1,393,818
CZ09	27%	(\$1,249,080)	\$146,671	>1	\$1,395,751
CZ10	22%	(\$1,246,081)	\$134,477	>1	\$1,380,559
CZ11	23%	(\$1,246,891)	\$157,138	>1	\$1,404,029
CZ12	27%	(\$1,248,330)	\$167,945	>1	\$1,416,276
CZ13	22%	(\$1,246,703)	\$149,270	>1	\$1,395,973
CZ14	21%	(\$1,247,061)	\$145,269	>1	\$1,392,331
CZ15	14%	(\$1,245,182)	\$93,647	>1	\$1,338,829
CZ16	20%	(\$1,254,665)	\$154,035	>1	\$1,408,701

**Figure 52. TDV Cost Effectiveness for Small Hotel, Propane Baseline – Package 3B (All-Electric + EE + PV)**

Climate Zone	Compliance Margin (%)	Incremental Package Cost	-\$-TDV Savings	B/C Ratio (TDV)	NPV (TDV)
CZ01	35%	(\$1,043,528)	\$511,688	>1	\$1,555,215
CZ02	34%	(\$1,044,500)	\$524,460	>1	\$1,568,960
CZ03	37%	(\$1,046,772)	\$518,485	>1	\$1,565,257
CZ04	31%	(\$1,043,399)	\$505,579	>1	\$1,548,978
CZ05	36%	(\$1,046,660)	\$526,668	>1	\$1,573,328
CZ06	25%	(\$1,043,594)	\$469,623	>1	\$1,513,216
CZ07	32%	(\$1,041,941)	\$471,513	>1	\$1,513,454
CZ08	29%	(\$1,039,912)	\$475,973	>1	\$1,515,885
CZ09	27%	(\$1,041,710)	\$467,971	>1	\$1,509,681
CZ10	22%	(\$1,038,711)	\$454,832	>1	\$1,493,543
CZ11	23%	(\$1,039,521)	\$474,844	>1	\$1,514,364
CZ12	27%	(\$1,040,960)	\$484,667	>1	\$1,525,627
CZ13	22%	(\$1,039,333)	\$454,108	>1	\$1,493,441
CZ14	21%	(\$1,039,691)	\$505,398	>1	\$1,545,090
CZ15	14%	(\$1,037,811)	\$423,879	>1	\$1,461,691
CZ16	20%	(\$1,047,295)	\$480,407	>1	\$1,527,702



**Figure 53. TDV Cost Effectiveness for Small Hotel, Propane Baseline – Package 3C (All Electric + HE)**

Climate Zone	Compliance Margin (%)	Incremental Package Cost	-\$TDV Savings	B/C Ratio (TDV)	NPV (TDV)
CZ01	27%	(\$1,256,423)	\$194,975	>1	\$1,451,398
CZ02	28%	(\$1,258,328)	\$177,378	>1	\$1,435,706
CZ03	28%	(\$1,263,867)	\$164,094	>1	\$1,427,961
CZ04	26%	(\$1,262,963)	\$155,314	>1	\$1,418,277
CZ05	26%	(\$1,263,327)	\$153,271	>1	\$1,416,598
CZ06	17%	(\$1,263,779)	\$122,011	>1	\$1,385,790
CZ07	24%	(\$1,260,844)	\$116,751	>1	\$1,377,594
CZ08	25%	(\$1,256,326)	\$122,995	>1	\$1,379,321
CZ09	24%	(\$1,260,223)	\$128,482	>1	\$1,388,706
CZ10	20%	(\$1,253,181)	\$121,595	>1	\$1,374,776
CZ11	21%	(\$1,254,613)	\$143,658	>1	\$1,398,271
CZ12	23%	(\$1,257,919)	\$142,901	>1	\$1,400,820
CZ13	21%	(\$1,254,386)	\$138,625	>1	\$1,393,011
CZ14	20%	(\$1,254,978)	\$136,430	>1	\$1,391,407
CZ15	14%	(\$1,251,932)	\$96,087	>1	\$1,348,019
CZ16	15%	(\$1,263,534)	\$122,011	>1	\$1,385,545



## 6.7 PV-only and PV+Battery-only Cost Effectiveness Results Details

The Reach Code Tea evaluated cost effectiveness of installing a PV system and battery storage in six different measure combinations over a 2019 code-compliant baseline for all climate zones. The baseline for all nonresidential buildings is a mixed-fuel design.

All mixed fuel models are compliant with 2019 Title24, whereas all electric models can show negative compliance. The compliance margin is the same as that of their respective federal minimum design and is not affected by addition of solar PV or battery. These scenarios evaluate the cost effectiveness of PV and/or battery measure individually. The climate zones where all-electric design is not compliant will have the flexibility to ramp up the efficiency of appliance or add another measure to be code compliant, as per package 1B and 3B in main body of the report. The large negative lifecycle costs in all electric packages are due to lower all-electric HVAC system costs and avoided natural gas infrastructure costs. This is commonly applied across all climate zones and packages over any additional costs for PV and battery.

### 6.7.1 Cost Effectiveness Results – Medium Office

Figure 54 through Figure 61 contain the cost-effectiveness findings for the Medium Office packages. Notable findings for each package include:

- ◆ **Mixed-Fuel + 3 kW PV Only:** All packages are cost effective using the On-Bill and TDV approaches.
- ◆ **Mixed-Fuel + 3 kW PV + 5 kWh Battery:** The packages are mostly cost effective on a TDV basis except in CZ1. As compared to the 3 kW PV only package, battery reduces cost effectiveness. This package is not cost effective for LADWP and SMUD territories using an On-Bill approach.
- ◆ **Mixed-Fuel + PV only:** The packages are less cost effective as compared to 3 kW PV packages in most climate zones. In areas served by LADWP, the B/C ratio is narrowly less than 1 and not cost effective.
- ◆ **Mixed-Fuel + PV + 50 kWh Battery:** The packages are cost effective in all climate zones except for in the areas served by LADWP. On-Bill and TDV B/C ratios are slightly lower compared to the PV only package.
- ◆ **All-Electric + 3 kW PV:** Packages are on-bill cost effective in ten of sixteen climate zones. Climate zones 1,2,4,12, and 16 were not found to be cost-effective from an on-bill perspective. These zones are within PG&E’s service area. Packages are cost effective using TDV in all climate zones except CZ16.
- ◆ **All-Electric + 3 kW PV + 5 kWh Battery:** Packages are slightly more cost effective than the previous minimal PV only package. Packages are on-bill cost effective in most climate zones except for 1,2 and 16 from an on-bill perspective. These zones are within PG&E’s service area. Packages are cost effective using TDV in all climate zones except CZ16.
- ◆ **All-Electric + PV only:** All packages are cost effective and achieve savings using the On-Bill and TDV approaches.





- ◆ **All-Electric + PV + 50 kWh Battery:** All packages are cost effective and achieve savings using the On-Bill and TDV approaches. On-Bill and TDV B/C ratios are slightly lower compared to the PV only package.



**Figure 54. Cost Effectiveness for Medium Office - Mixed Fuel + 3kW PV**

CZ	IOU territory	Elec Savings (kWh)	Gas Savings (therms)	GHG savings (tons)	Incremental Package Cost	Lifecycle Energy Cost Savings	Lifecycle \$-TDV Savings	B/C Ratio (On-bill)	B/C Ratio (TDV)	NPV (On-bill)	NPV (TDV)
<b>Mixed Fuel + 3kW PV</b>											
CZ01	PG&E	3,941	0	0.8	\$5,566	\$15,743	\$8,448	2.8	1.5	\$10,177	\$2,882
CZ02	PG&E	4,785	0	0.9	\$5,566	\$20,372	\$10,500	3.7	1.9	\$14,806	\$4,934
CZ03	PG&E	4,660	0	0.9	\$5,566	\$20,603	\$9,975	3.7	1.8	\$15,037	\$4,409
CZ04	PG&E	5,056	0	1.0	\$5,566	\$20,235	\$11,073	3.6	2.0	\$14,669	\$5,507
CZ04-2	CPAU	5,056	0	1.0	\$5,566	\$11,945	\$11,073	2.1	2.0	\$6,379	\$5,507
CZ05	PG&E	5,027	0	1.0	\$5,566	\$23,159	\$10,834	4.2	1.9	\$17,593	\$5,268
CZ06	SCE	4,853	0	0.9	\$5,566	\$10,968	\$10,930	2.0	2.0	\$5,402	\$5,364
CZ06-2	LADWP	4,853	0	0.9	\$5,566	\$6,575	\$10,930	1.2	2.0	\$1,009	\$5,364
CZ07	SDG&E	4,960	0	1.0	\$5,566	\$17,904	\$11,025	3.2	2.0	\$12,338	\$5,459
CZ08	SCE	4,826	0	0.9	\$5,566	\$10,768	\$11,359	1.9	2.0	\$5,202	\$5,793
CZ08-2	LADWP	4,826	0	0.9	\$5,566	\$6,503	\$11,359	1.2	2.0	\$937	\$5,793
CZ09	SCE	4,889	0	1.0	\$5,566	\$10,622	\$11,216	1.9	2.0	\$5,056	\$5,650
CZ09-2	LADWP	4,889	0	1.0	\$5,566	\$6,217	\$11,216	1.1	2.0	\$651	\$5,650
CZ10	SDG&E	4,826	0	0.9	\$5,566	\$21,280	\$10,787	3.8	1.9	\$15,714	\$5,221
CZ10-2	SCE	4,826	0	0.9	\$5,566	\$11,598	\$10,787	2.1	1.9	\$6,032	\$5,221
CZ11	PG&E	4,701	0	0.9	\$5,566	\$19,869	\$10,644	3.6	1.9	\$14,303	\$5,078
CZ12	PG&E	4,707	0	0.9	\$5,566	\$19,643	\$10,644	3.5	1.9	\$14,077	\$5,078
CZ12-2	SMUD	4,707	0	0.9	\$5,566	\$8,005	\$10,644	1.4	1.9	\$2,439	\$5,078
CZ13	PG&E	4,633	0	0.9	\$5,566	\$19,231	\$10,262	3.5	1.8	\$13,665	\$4,696
CZ14	SDG&E	5,377	0	1.0	\$5,566	\$18,789	\$12,600	3.4	2.3	\$13,223	\$7,034
CZ14-2	SCE	5,377	0	1.0	\$5,566	\$10,512	\$12,600	1.9	2.3	\$4,946	\$7,034
CZ15	SCE	5,099	0	1.0	\$5,566	\$10,109	\$11,550	1.8	2.1	\$4,543	\$5,984
CZ16	PG&E	5,096	0	1.0	\$5,566	\$21,836	\$10,882	3.9	2.0	\$16,270	\$5,316
CZ16-2	LADWP	5,096	0	1.0	\$5,566	\$6,501	\$10,882	1.2	2.0	\$935	\$5,316



**Figure 55. Cost Effectiveness for Medium Office - Mixed Fuel + 3kW PV + 5 kWh Battery**

CZ	IOU territory	Elec Savings (kWh)	Gas Savings (therms)	GHG savings (tons)	Incremental Package Cost	Lifecycle Energy Cost Savings	\$-TDV Savings	B/C Ratio (On-bill)	B/C Ratio (TDV)	NPV (On-bill)	NPV (TDV)
<b>Mixed Fuel + 3kW PV + 5kWh Battery</b>											
CZ01	PG&E	3,941	0	0.8	\$9,520	\$15,743	\$8,448	1.7	0.9	\$6,223	(\$1,072)
CZ02	PG&E	4,785	0	0.9	\$9,520	\$20,372	\$10,500	2.1	1.1	\$10,852	\$980
CZ03	PG&E	4,660	0	0.9	\$9,520	\$20,603	\$9,975	2.2	1.0	\$11,083	\$455
CZ04	PG&E	5,056	0	1.0	\$9,520	\$20,235	\$11,073	2.1	1.2	\$10,714	\$1,553
CZ04-2	CPAU	5,056	0	1.0	\$9,520	\$11,945	\$11,073	1.3	1.2	\$2,425	\$1,553
CZ05	PG&E	5,027	0	1.0	\$9,520	\$23,159	\$10,834	2.4	1.1	\$13,639	\$1,314
CZ06	SCE	4,853	0	0.9	\$9,520	\$10,968	\$10,930	1.2	1.1	\$1,448	\$1,410
CZ06-2	LADWP	4,853	0	0.9	\$9,520	\$6,575	\$10,930	0.7	1.1	(\$2,945)	\$1,410
CZ07	SDG&E	4,960	0	1.0	\$9,520	\$17,904	\$11,025	1.9	1.2	\$8,384	\$1,505
CZ08	SCE	4,826	0	0.9	\$9,520	\$10,768	\$11,359	1.1	1.2	\$1,248	\$1,839
CZ08-2	LADWP	4,826	0	0.9	\$9,520	\$6,503	\$11,359	0.7	1.2	(\$3,017)	\$1,839
CZ09	SCE	4,889	0	1.0	\$9,520	\$10,622	\$11,216	1.1	1.2	\$1,102	\$1,696
CZ09-2	LADWP	4,889	0	1.0	\$9,520	\$6,217	\$11,216	0.7	1.2	(\$3,303)	\$1,696
CZ10	SDG&E	4,826	0	0.9	\$9,520	\$21,280	\$10,787	2.2	1.1	\$11,760	\$1,267
CZ10-2	SCE	4,826	0	0.9	\$9,520	\$11,598	\$10,787	1.2	1.1	\$2,078	\$1,267
CZ11	PG&E	4,701	0	0.9	\$9,520	\$19,869	\$10,644	2.1	1.1	\$10,349	\$1,123
CZ12	PG&E	4,707	0	0.9	\$9,520	\$19,643	\$10,644	2.1	1.1	\$10,123	\$1,123
CZ12-2	SMUD	4,707	0	0.9	\$9,520	\$8,005	\$10,644	0.8	1.1	(\$1,515)	\$1,123
CZ13	PG&E	4,633	0	0.9	\$9,520	\$19,231	\$10,262	2.0	1.1	\$9,711	\$742
CZ14	SDG&E	5,377	0	1.0	\$9,520	\$18,789	\$12,600	2.0	1.3	\$9,269	\$3,080
CZ14-2	SCE	5,377	0	1.0	\$9,520	\$10,512	\$12,600	1.1	1.3	\$992	\$3,080
CZ15	SCE	5,099	0	1.0	\$9,520	\$10,109	\$11,550	1.1	1.2	\$589	\$2,030
CZ16	PG&E	5,096	0	1.0	\$9,520	\$21,836	\$10,882	2.3	1.1	\$12,316	\$1,362
CZ16-2	LADWP	5,096	0	1.0	\$9,520	\$6,501	\$10,882	0.7	1.1	(\$3,019)	\$1,362



**Figure 56. Cost Effectiveness for Medium Office – Mixed Fuel + 135kW PV**

CZ	IOU territory	Elec Savings (kWh)	Gas Savings (therms)	GHG savings (tons)	Incremental Package Cost	Lifecycle Energy Cost Savings	Lifecycle TDV Savings	B/C Ratio (On-bill)	B/C Ratio (TDV)	NPV (On-bill)	NPV (TDV)
<b>Mixed Fuel +135kW PV</b>											
CZ01	PG&E	177,340	0	34.3	\$302,856	\$526,352	\$380,399	1.7	1.3	\$223,497	\$77,544
CZ02	PG&E	215,311	0	41.5	\$302,856	\$666,050	\$471,705	2.2	1.6	\$363,194	\$168,849
CZ03	PG&E	209,717	0	40.7	\$302,856	\$645,010	\$449,797	2.1	1.5	\$342,154	\$146,942
CZ04	PG&E	227,535	0	44.0	\$302,856	\$686,434	\$497,431	2.3	1.6	\$383,578	\$194,575
CZ04-2	CPAU	227,535	0	44.0	\$302,856	\$537,521	\$497,431	1.8	1.6	\$234,665	\$194,575
CZ05	PG&E	226,195	0	44.1	\$302,856	\$753,230	\$486,596	2.5	1.6	\$450,374	\$183,741
CZ06	SCE	218,387	0	42.3	\$302,856	\$401,645	\$492,515	1.3	1.6	\$98,789	\$189,659
CZ06-2	LADWP	218,387	0	42.3	\$302,856	\$233,909	\$492,515	0.8	1.6	(\$68,947)	\$189,659
CZ07	SDG&E	223,185	0	43.3	\$302,856	\$623,078	\$496,667	2.1	1.6	\$320,223	\$193,811
CZ08	SCE	217,171	0	42.0	\$302,856	\$389,435	\$510,270	1.3	1.7	\$86,579	\$207,414
CZ08-2	LADWP	217,171	0	42.0	\$302,856	\$222,066	\$510,270	0.7	1.7	(\$80,790)	\$207,414
CZ09	SCE	220,010	0	43.2	\$302,856	\$387,977	\$505,783	1.3	1.7	\$85,122	\$202,928
CZ09-2	LADWP	220,010	0	43.2	\$302,856	\$226,516	\$505,783	0.7	1.7	(\$76,340)	\$202,928
CZ10	SDG&E	217,148	0	42.5	\$302,856	\$632,726	\$485,451	2.1	1.6	\$329,870	\$182,595
CZ10-2	SCE	217,148	0	42.5	\$302,856	\$394,884	\$485,451	1.3	1.6	\$92,028	\$182,595
CZ11	PG&E	211,556	0	40.9	\$302,856	\$671,691	\$478,912	2.2	1.6	\$368,835	\$176,056
CZ12	PG&E	211,824	0	40.9	\$302,856	\$653,242	\$478,101	2.2	1.6	\$350,386	\$175,245
CZ12-2	SMUD	211,824	0	40.9	\$302,856	\$345,255	\$478,101	1.1	1.6	\$42,399	\$175,245
CZ13	PG&E	208,465	0	40.5	\$302,856	\$651,952	\$462,732	2.2	1.5	\$349,096	\$159,876
CZ14	SDG&E	241,965	0	46.7	\$302,856	\$659,487	\$566,351	2.2	1.9	\$356,632	\$263,496
CZ14-2	SCE	241,965	0	46.7	\$302,856	\$401,712	\$566,351	1.3	1.9	\$98,856	\$263,496
CZ15	SCE	229,456	0	43.9	\$302,856	\$378,095	\$520,102	1.2	1.7	\$75,239	\$217,246
CZ16	PG&E	229,317	0	44.8	\$302,856	\$707,095	\$489,508	2.3	1.6	\$404,239	\$186,652
CZ16-2	LADWP	229,317	0	44.8	\$302,856	\$223,057	\$489,508	0.7	1.6	(\$79,799)	\$186,652



**Figure 57. Cost Effectiveness for Medium Office – Mixed Fuel + 135kW PV + 50 kWh Battery**

CZ	IOU territory	Elec Savings (kWh)	Gas Savings (therms)	GHG savings (tons)	Incremental Package Cost	Lifecycle Energy Cost Savings	Lifecycle TDV Savings	B/C Ratio (On-bill)	B/C Ratio (TDV)	NPV (On-bill)	NPV (TDV)
<b>Mixed Fuel + 135kW PV + 50 kWh Battery</b>											
CZ01	PG&E	176,903	0	35.3	\$330,756	\$525,948	\$381,450	1.6	1.2	\$195,192	\$50,694
CZ02	PG&E	214,861	0	42.6	\$330,756	\$665,864	\$472,898	2.0	1.4	\$335,108	\$142,142
CZ03	PG&E	209,255	0	41.8	\$330,756	\$644,170	\$451,611	1.9	1.4	\$313,414	\$120,855
CZ04	PG&E	227,076	0	45.0	\$330,756	\$685,605	\$502,108	2.1	1.5	\$354,849	\$171,352
CZ04-2	CPAU	227,076	0	45.0	\$330,756	\$536,463	\$502,108	1.6	1.5	\$205,707	\$171,352
CZ05	PG&E	225,752	0	45.1	\$330,756	\$753,558	\$487,742	2.3	1.5	\$422,803	\$156,986
CZ06	SCE	217,939	0	43.4	\$330,756	\$401,356	\$494,042	1.2	1.5	\$70,601	\$163,286
CZ06-2	LADWP	217,939	0	43.4	\$330,756	\$233,673	\$494,042	0.7	1.5	(\$97,083)	\$163,286
CZ07	SDG&E	222,746	0	44.4	\$330,756	\$628,383	\$498,147	1.9	1.5	\$297,627	\$167,391
CZ08	SCE	216,724	0	43.1	\$330,756	\$389,184	\$511,511	1.2	1.5	\$58,428	\$180,755
CZ08-2	LADWP	216,724	0	43.1	\$330,756	\$221,839	\$511,511	0.7	1.5	(\$108,917)	\$180,755
CZ09	SCE	219,563	0	44.2	\$330,756	\$387,728	\$506,929	1.2	1.5	\$56,972	\$176,173
CZ09-2	LADWP	219,563	0	44.2	\$330,756	\$226,303	\$506,929	0.7	1.5	(\$104,453)	\$176,173
CZ10	SDG&E	216,700	0	43.5	\$330,756	\$638,040	\$486,644	1.9	1.5	\$307,284	\$155,888
CZ10-2	SCE	216,700	0	43.5	\$330,756	\$394,633	\$486,644	1.2	1.5	\$63,877	\$155,888
CZ11	PG&E	211,129	0	41.9	\$330,756	\$670,932	\$481,298	2.0	1.5	\$340,177	\$150,543
CZ12	PG&E	211,386	0	41.9	\$330,756	\$652,465	\$482,826	2.0	1.5	\$321,709	\$152,070
CZ12-2	SMUD	211,386	0	41.9	\$330,756	\$344,668	\$482,826	1.0	1.5	\$13,913	\$152,070
CZ13	PG&E	208,045	0	41.5	\$330,756	\$651,191	\$473,280	2.0	1.4	\$320,435	\$142,524
CZ14	SDG&E	241,502	0	47.7	\$330,756	\$672,601	\$569,454	2.0	1.7	\$341,846	\$238,698
CZ14-2	SCE	241,502	0	47.7	\$330,756	\$401,450	\$569,454	1.2	1.7	\$70,694	\$238,698
CZ15	SCE	229,062	0	44.8	\$330,756	\$377,827	\$521,963	1.1	1.6	\$47,071	\$191,208
CZ16	PG&E	228,825	0	45.9	\$330,756	\$706,201	\$496,190	2.1	1.5	\$375,445	\$165,434
CZ16-2	LADWP	228,825	0	45.9	\$330,756	\$222,802	\$496,190	0.7	1.5	(\$107,953)	\$165,434



**Figure 58. Cost Effectiveness for Medium Office– All-Electric + 3kW PV**

CZ	IOU territory	Elec Savings (kWh)	Gas Savings (therms)	GHG savings (tons)	Incremental Package Cost	Lifecycle Energy Cost Savings	Lifecycle TDV Savings	B/C Ratio (On-bill)	B/C Ratio (TDV)	NPV (On-bill)	NPV (TDV)
<b>All-Electric + 3kW PV</b>											
CZ01	PG&E	-49,716	4967	10.9	(\$80,523)	(\$84,765)	(\$49,972)	0.9	1.6	(\$4,242)	\$30,551
CZ02	PG&E	-44,899	3868	6.0	(\$66,965)	(\$83,115)	(\$30,928)	0.8	2.2	(\$16,150)	\$36,037
CZ03	PG&E	-31,226	3142	6.5	(\$75,600)	(\$39,441)	(\$19,617)	1.9	3.9	\$36,159	\$55,983
CZ04	PG&E	-43,772	3759	5.7	(\$62,282)	(\$70,999)	(\$29,496)	0.9	2.1	(\$8,717)	\$32,786
CZ04-2	CPAU	-43,772	3759	5.7	(\$62,282)	(\$8,050)	(\$29,496)	7.7	2.1	\$54,232	\$32,786
CZ05	PG&E	-35,504	3240	5.5	(\$77,773)	(\$42,559)	(\$29,162)	1.8	2.7	\$35,214	\$48,611
CZ06	SCE	-21,321	2117	4.0	(\$69,422)	\$35,862	(\$9,641)	>1	7.2	\$105,284	\$59,781
CZ06-2	LADWP	-21,321	2117	4.0	(\$69,422)	\$32,936	(\$9,641)	>1	7.2	\$102,358	\$59,781
CZ07	SDG&E	-7,943	950	1.9	(\$63,595)	\$64,781	(\$382)	>1	166.6	\$128,376	\$63,214
CZ08	SCE	-10,854	1219	2.5	(\$62,043)	\$28,651	(\$1,289)	>1	48.1	\$90,694	\$60,755
CZ08-2	LADWP	-10,854	1219	2.5	(\$62,043)	\$25,122	(\$1,289)	>1	48.1	\$87,165	\$60,755
CZ09	SCE	-14,878	1605	3.3	(\$56,372)	\$31,542	(\$3,246)	>1	17.4	\$87,913	\$53,126
CZ09-2	LADWP	-14,878	1605	3.3	(\$56,372)	\$28,145	(\$3,246)	>1	17.4	\$84,517	\$53,126
CZ10	SDG&E	-22,588	2053	3.1	(\$41,171)	\$59,752	(\$12,553)	>1	3.3	\$100,924	\$28,619
CZ10-2	SCE	-22,588	2053	3.1	(\$41,171)	\$32,039	(\$12,553)	>1	3.3	\$73,211	\$28,619
CZ11	PG&E	-35,455	3062	4.5	(\$57,257)	(\$53,776)	(\$22,194)	1.1	2.6	\$3,481	\$35,063
CZ12	PG&E	-38,704	3327	5.0	(\$61,613)	(\$66,808)	(\$24,819)	0.9	2.5	(\$5,195)	\$36,794
CZ12-2	SMUD	-38,704	3327	5.0	(\$61,613)	\$2,897	(\$24,819)	>1	2.5	\$64,510	\$36,794
CZ13	PG&E	-35,016	3063	4.7	(\$55,996)	(\$52,159)	(\$22,146)	1.1	2.5	\$3,836	\$33,849
CZ14	SDG&E	-38,945	3266	4.5	(\$58,426)	\$24,867	(\$25,821)	>1	2.3	\$83,293	\$32,605
CZ14-2	SCE	-38,945	3266	4.5	(\$58,426)	\$15,338	(\$25,821)	>1	2.3	\$73,764	\$32,605
CZ15	SCE	-14,818	1537	2.8	(\$29,445)	\$22,852	(\$3,914)	>1	7.5	\$52,298	\$25,532
CZ16	PG&E	-88,966	6185	6.6	(\$57,366)	(\$193,368)	(\$139,989)	0.3	0.4	(\$136,002)	(\$82,623)
CZ16-2	LADWP	-88,966	6185	6.6	(\$57,366)	\$36,354	(\$139,989)	>1	0.4	\$93,720	(\$82,623)



**Figure 59. Cost Effectiveness for Medium Office – All-Electric + 3kW PV + 5 kWh Battery**

CZ	IOU territory	Elec Savings (kWh)	Gas Savings (therms)	GHG savings (tons)	Incremental Package Cost	Lifecycle Energy Cost Savings	\$-TDV Savings	B/C Ratio (On-bill)	B/C Ratio (TDV)	NPV (On-bill)	NPV (TDV)
<b>All-Electric + 3kW PV + 5 kWh Battery</b>											
CZ01	PG&E	-49,716	4967	10.9	(\$78,897)	(\$84,765)	(\$49,972)	0.9	1.6	(\$5,868)	\$28,925
CZ02	PG&E	-44,899	3868	6.0	(\$78,897)	(\$83,115)	(\$30,928)	0.9	2.6	(\$4,218)	\$47,969
CZ03	PG&E	-31,226	3142	6.5	(\$78,897)	(\$39,441)	(\$19,617)	2.0	4.0	\$39,456	\$59,280
CZ04	PG&E	-43,772	3759	5.7	(\$78,897)	(\$70,999)	(\$29,496)	1.1	2.7	\$7,898	\$49,400
CZ04-2	CPAU	-43,772	3759	5.7	(\$78,897)	(\$8,050)	(\$29,496)	9.8	2.7	\$70,847	\$49,400
CZ05	PG&E	-35,504	3240	5.5	(\$78,897)	(\$42,559)	(\$29,162)	1.9	2.7	\$36,338	\$49,735
CZ06	SCE	-21,321	2117	4.0	(\$78,897)	\$35,862	(\$9,641)	>1	8.2	\$114,759	\$69,256
CZ06-2	LADWP	-21,321	2117	4.0	(\$78,897)	\$32,936	(\$9,641)	>1	8.2	\$111,833	\$69,256
CZ07	SDG&E	-7,943	950	1.9	(\$78,897)	\$64,781	(\$382)	>1	206.6	\$143,678	\$78,515
CZ08	SCE	-10,854	1219	2.5	(\$78,897)	\$28,651	(\$1,289)	>1	61.2	\$107,548	\$77,608
CZ08-2	LADWP	-10,854	1219	2.5	(\$78,897)	\$25,122	(\$1,289)	>1	61.2	\$104,019	\$77,608
CZ09	SCE	-14,878	1605	3.3	(\$78,897)	\$31,542	(\$3,246)	>1	24.3	\$110,439	\$75,651
CZ09-2	LADWP	-14,878	1605	3.3	(\$78,897)	\$28,145	(\$3,246)	>1	24.3	\$107,042	\$75,651
CZ10	SDG&E	-22,588	2053	3.1	(\$78,897)	\$59,752	(\$12,553)	>1	6.3	\$138,649	\$66,344
CZ10-2	SCE	-22,588	2053	3.1	(\$78,897)	\$32,039	(\$12,553)	>1	6.3	\$110,936	\$66,344
CZ11	PG&E	-35,455	3062	4.5	(\$78,897)	(\$53,776)	(\$22,194)	1.5	3.6	\$25,121	\$56,703
CZ12	PG&E	-38,704	3327	5.0	(\$78,897)	(\$66,808)	(\$24,819)	1.2	3.2	\$12,089	\$54,078
CZ12-2	SMUD	-38,704	3327	5.0	(\$78,897)	\$2,897	(\$24,819)	>1	3.2	\$81,794	\$54,078
CZ13	PG&E	-35,016	3063	4.7	(\$78,897)	(\$52,159)	(\$22,146)	1.5	3.6	\$26,738	\$56,751
CZ14	SDG&E	-38,945	3266	4.5	(\$78,897)	\$24,867	(\$25,821)	>1	3.1	\$103,764	\$53,076
CZ14-2	SCE	-38,945	3266	4.5	(\$78,897)	\$15,338	(\$25,821)	>1	3.1	\$94,235	\$53,076
CZ15	SCE	-14,818	1537	2.8	(\$78,897)	\$22,852	(\$3,914)	>1	20.2	\$101,749	\$74,983
CZ16	PG&E	-88,966	6185	6.6	(\$78,897)	(\$193,368)	(\$139,989)	0.4	0.6	(\$114,472)	(\$61,092)
CZ16-2	LADWP	-88,966	6185	6.6	(\$78,897)	\$36,354	(\$139,989)	>1	0.6	\$115,250	(\$61,092)



**Figure 60. Cost Effectiveness for Medium Office - All-Electric + 135kW PV**

CZ	IOU territory	Elec Savings (kWh)	Gas Savings (therms)	GHG savings (tons)	Incremental Package Cost	Lifecycle Energy Cost Savings	Lifecycle TDV Savings	B/C Ratio (On-bill)	B/C Ratio (TDV)	NPV (On-bill)	NPV (TDV)
<b>All-Electric + 135kW PV</b>											
CZ01	PG&E	123,683	4967	44.5	\$163,217	\$405,731	\$321,979	2.5	2.0	\$242,514	\$158,762
CZ02	PG&E	165,627	3868	46.6	\$176,775	\$562,528	\$430,276	3.2	2.4	\$385,753	\$253,501
CZ03	PG&E	173,831	3142	46.3	\$168,140	\$575,864	\$420,205	3.4	2.5	\$407,725	\$252,066
CZ04	PG&E	178,706	3759	48.7	\$181,458	\$601,431	\$456,861	3.3	2.5	\$419,973	\$275,403
CZ04-2	CPAU	178,706	3759	48.7	\$181,458	\$517,526	\$456,861	2.9	2.5	\$336,069	\$275,403
CZ05	PG&E	185,664	3240	48.6	\$165,967	\$664,842	\$446,600	4.0	2.7	\$498,875	\$280,633
CZ06	SCE	192,214	2117	45.3	\$174,317	\$423,657	\$471,944	2.4	2.7	\$249,340	\$297,626
CZ06-2	LADWP	192,214	2117	45.3	\$174,317	\$259,270	\$471,944	1.5	2.7	\$84,953	\$297,626
CZ07	SDG&E	210,282	950	44.3	\$180,145	\$669,979	\$485,260	3.7	2.7	\$489,834	\$305,115
CZ08	SCE	201,491	1219	43.5	\$181,696	\$407,277	\$497,622	2.2	2.7	\$225,580	\$315,925
CZ08-2	LADWP	201,491	1219	43.5	\$181,696	\$240,657	\$497,622	1.3	2.7	\$58,960	\$315,925
CZ09	SCE	200,242	1605	45.6	\$187,368	\$408,922	\$491,322	2.2	2.6	\$221,554	\$303,953
CZ09-2	LADWP	200,242	1605	45.6	\$187,368	\$248,452	\$491,322	1.3	2.6	\$61,084	\$303,953
CZ10	SDG&E	189,734	2053	44.7	\$202,568	\$667,551	\$462,111	3.3	2.3	\$464,982	\$259,543
CZ10-2	SCE	189,734	2053	44.7	\$202,568	\$412,659	\$462,111	2.0	2.3	\$210,091	\$259,543
CZ11	PG&E	171,399	3062	44.5	\$186,483	\$597,807	\$446,074	3.2	2.4	\$411,324	\$259,592
CZ12	PG&E	168,413	3327	45.0	\$182,127	\$571,758	\$442,638	3.1	2.4	\$389,632	\$260,511
CZ12-2	SMUD	168,413	3327	45.0	\$182,127	\$343,602	\$442,638	1.9	2.4	\$161,475	\$260,511
CZ13	PG&E	168,817	3063	44.3	\$187,744	\$581,964	\$430,324	3.1	2.3	\$394,220	\$242,580
CZ14	SDG&E	197,643	3266	50.1	\$185,314	\$667,762	\$527,930	3.6	2.8	\$482,449	\$342,616
CZ14-2	SCE	197,643	3266	50.1	\$185,314	\$408,424	\$527,930	2.2	2.8	\$223,110	\$342,616
CZ15	SCE	209,539	1537	45.7	\$214,294	\$390,267	\$504,638	1.8	2.4	\$175,972	\$290,343
CZ16	PG&E	135,255	6185	50.4	\$186,374	\$470,199	\$338,637	2.5	1.8	\$283,825	\$152,263
CZ16-2	LADWP	135,255	6185	50.4	\$186,374	\$250,807	\$338,637	1.3	1.8	\$64,433	\$152,263





**Figure 61. Cost Effectiveness for Medium Office – All-Electric + 135kW PV + 50 kWh Battery**

CZ	IOU territory	Elec Savings (kWh)	Gas Savings (therms)	GHG savings (tons)	Incremental Package Cost	Lifecycle Energy Cost Savings	Lifecycle TDV Savings	B/C Ratio (On-bill)	B/C Ratio (TDV)	NPV (On-bill)	NPV (TDV)
<b>All-Electric + 135kW PV + 50 kWh Battery</b>											
CZ01	PG&E	123,280	4967	45.4	\$191,117	\$404,994	\$323,077	2.1	1.7	\$213,877	\$131,960
CZ02	PG&E	165,200	3868	47.7	\$204,675	\$561,747	\$431,469	2.7	2.1	\$357,072	\$226,795
CZ03	PG&E	173,384	3142	47.4	\$196,040	\$575,043	\$422,019	2.9	2.2	\$379,003	\$225,979
CZ04	PG&E	178,259	3759	49.8	\$209,358	\$600,621	\$461,634	2.9	2.2	\$391,263	\$252,276
CZ04-2	CPAU	178,259	3759	49.8	\$209,358	\$516,495	\$461,634	2.5	2.2	\$307,137	\$252,276
CZ05	PG&E	185,229	3240	49.7	\$193,867	\$664,046	\$447,793	3.4	2.3	\$470,179	\$253,926
CZ06	SCE	191,767	2117	46.5	\$202,217	\$423,369	\$473,519	2.1	2.3	\$221,152	\$271,301
CZ06-2	LADWP	191,767	2117	46.5	\$202,217	\$259,033	\$473,519	1.3	2.3	\$56,816	\$271,301
CZ07	SDG&E	209,848	950	45.4	\$208,045	\$675,307	\$486,787	3.2	2.3	\$467,262	\$278,743
CZ08	SCE	201,047	1219	44.7	\$209,596	\$407,027	\$498,910	1.9	2.4	\$197,430	\$289,314
CZ08-2	LADWP	201,047	1219	44.7	\$209,596	\$240,432	\$498,910	1.1	2.4	\$30,835	\$289,314
CZ09	SCE	199,802	1605	46.6	\$215,268	\$408,676	\$492,515	1.9	2.3	\$193,408	\$277,246
CZ09-2	LADWP	199,802	1605	46.6	\$215,268	\$248,242	\$492,515	1.2	2.3	\$32,974	\$277,246
CZ10	SDG&E	189,293	2053	45.7	\$230,468	\$672,867	\$463,352	2.9	2.0	\$442,399	\$232,884
CZ10-2	SCE	189,293	2053	45.7	\$230,468	\$412,412	\$463,352	1.8	2.0	\$181,944	\$232,884
CZ11	PG&E	170,987	3062	45.5	\$214,383	\$597,062	\$448,509	2.8	2.1	\$382,680	\$234,126
CZ12	PG&E	167,995	3327	46.0	\$210,027	\$571,002	\$447,411	2.7	2.1	\$360,975	\$237,384
CZ12-2	SMUD	167,995	3327	46.0	\$210,027	\$343,043	\$447,411	1.6	2.1	\$133,017	\$237,384
CZ13	PG&E	168,408	3063	45.3	\$215,644	\$581,225	\$440,920	2.7	2.0	\$365,580	\$225,275
CZ14	SDG&E	197,188	3266	51.2	\$213,214	\$680,893	\$531,080	3.2	2.5	\$467,679	\$317,866
CZ14-2	SCE	197,188	3266	51.2	\$213,214	\$408,166	\$531,080	1.9	2.5	\$194,952	\$317,866
CZ15	SCE	209,148	1537	46.6	\$242,194	\$390,000	\$506,499	1.6	2.1	\$147,806	\$264,305
CZ16	PG&E	134,809	6185	51.4	\$214,274	\$469,378	\$341,978	2.2	1.6	\$255,105	\$127,704
CZ16-2	LADWP	134,809	6185	51.4	\$214,274	\$250,580	\$341,978	1.2	1.6	\$36,306	\$127,704



### 6.7.2 Cost Effectiveness Results – Medium Retail

Figure 62 through Figure 69 contain the cost-effectiveness findings for the Medium Retail packages. Notable findings for each package include:

- ◆ **Mixed-Fuel + 3 kW PV:** Packages are cost effective and achieve savings for all climate zones using the On-Bill and TDV approaches.
- ◆ **Mixed-Fuel + 3 kW PV + 5 kWh Battery:** The packages are less cost effective as compared to the 3 kW PV only package and not cost effective for LADWP and SMUD service area.
- ◆ **Mixed-Fuel + PV only:** Packages achieve positive energy cost savings and are cost effective using the On-Bill approach for all climate zones except for LADWP territory (CZs 6, 8, 9 and 16). Packages achieve positive savings and are cost effective using the TDV approach for all climate zones.
- ◆ **Mixed Fuel + PV + 5 kWh Battery:** Adding battery slightly reduces On-Bill B/C ratios but is still cost effective for all climate zones except for LADWP territory. Packages achieve savings and cost effective using the TDV approach for all climate zones.
- ◆ **All-Electric + 3 kW PV:** Packages are cost effective using the On-Bill and TDV approach for all climate zones except for CZ16 under PG&E service.
- ◆ **All-Electric + 3 kW PV + 5 kWh Battery:** Similar to minimal PV only package, adding battery is cost effective as well using the On-Bill and TDV approach for all climate zones except for CZ16 under PG&E service.
- ◆ **All-Electric + PV only:** Packages are cost effective and achieve savings in all climate zones for both the On-Bill and TDV approaches
- ◆ **All-Electric + PV + 50 kWh Battery:** Adding battery slightly reduces B/C ratios for both the On-Bill and TDV approaches. Packages are not cost effective for all climate zones except CZ6, CZ8 and CZ9 under LADWP service area.



**Figure 62. Cost Effectiveness for Medium Retail – Mixed-Fuel + 3kW PV**

CZ	IOU territory	Elec Savings (kWh)	Gas Savings (therms)	GHG savings (tons)	Incremental Package Cost	Lifecycle Energy Cost Savings	Lifecycle TDV Savings	B/C Ratio (On-bill)	B/C Ratio (TDV)	NPV (On-bill)	NPV (TDV)
<b>Mixed Fuel + 3kW PV</b>											
CZ01	PG&E	3,941	0	0.76	\$5,566	\$12,616	\$8,460	2.3	1.5	\$7,050	\$2,894
CZ02	PG&E	4,685	0	0.91	\$5,566	\$17,635	\$10,262	3.2	1.8	\$12,069	\$4,696
CZ03	PG&E	4,733	0	0.92	\$5,566	\$15,146	\$10,152	2.7	1.8	\$9,580	\$4,586
CZ04	PG&E	4,834	0	0.94	\$5,566	\$18,519	\$10,614	3.3	1.9	\$12,953	\$5,048
CZ04-2	CPAU	4,834	0	0.94	\$5,566	\$11,507	\$10,614	2.1	1.9	\$5,941	\$5,048
CZ05	PG&E	4,910	0	0.95	\$5,566	\$15,641	\$10,548	2.8	1.9	\$10,075	\$4,982
CZ06	SCE	4,769	0	0.93	\$5,566	\$11,374	\$10,724	2.0	1.9	\$5,808	\$5,158
CZ06-2	LA	4,769	0	0.93	\$5,566	\$7,069	\$10,724	1.3	1.9	\$1,503	\$5,158
CZ07	SDG&E	4,960	0	0.96	\$5,566	\$22,452	\$11,031	4.0	2.0	\$16,886	\$5,465
CZ08	SCE	4,826	0	0.93	\$5,566	\$11,838	\$11,339	2.1	2.0	\$6,272	\$5,773
CZ08-2	LA	4,826	0	0.93	\$5,566	\$7,342	\$11,339	1.3	2.0	\$1,776	\$5,773
CZ09	SCE	4,889	0	0.96	\$5,566	\$11,187	\$11,229	2.0	2.0	\$5,621	\$5,663
CZ09-2	LA	4,889	0	0.96	\$5,566	\$6,728	\$11,229	1.2	2.0	\$1,162	\$5,663
CZ10	SDG&E	4,948	0	0.97	\$5,566	\$20,999	\$10,987	3.8	2.0	\$15,433	\$5,421
CZ10-2	SCE	4,948	0	0.97	\$5,566	\$11,384	\$10,987	2.0	2.0	\$5,818	\$5,421
CZ11	PG&E	4,718	0	0.91	\$5,566	\$15,381	\$10,680	2.8	1.9	\$9,815	\$5,114
CZ12	PG&E	4,707	0	0.91	\$5,566	\$16,442	\$10,614	3.0	1.9	\$10,876	\$5,048
CZ12-2	SMUD	4,707	0	0.91	\$5,566	\$8,247	\$10,614	1.5	1.9	\$2,681	\$5,048
CZ13	PG&E	4,750	0	0.92	\$5,566	\$16,638	\$10,592	3.0	1.9	\$11,072	\$5,026
CZ14	SDG&E	5,258	0	1.01	\$5,566	\$19,576	\$12,218	3.5	2.2	\$14,010	\$6,652
CZ14-2	SCE	5,258	0	1.01	\$5,566	\$10,227	\$12,218	1.8	2.2	\$4,661	\$6,652
CZ15	SCE	4,997	0	0.96	\$5,566	\$10,476	\$11,339	1.9	2.0	\$4,910	\$5,773
CZ16	PG&E	5,336	0	1.04	\$5,566	\$20,418	\$11,361	3.7	2.0	\$14,852	\$5,795
CZ16-2	LA	5,336	0	1.04	\$5,566	\$6,987	\$11,361	1.3	2.0	\$1,421	\$5,795



**Figure 63. Cost Effectiveness for Medium Retail – Mixed Fuel + 3kW PV + 5 kWh Battery**

CZ	IOU territory	Elec Savings (kWh)	Gas Savings (therms)	GHG savings (tons)	Incremental Package Cost	Lifecycle Energy Cost Savings	-\$-TDV Savings	B/C Ratio (On-bill)	B/C Ratio (TDV)	NPV (On-bill)	NPV (TDV)
<b>Mixed Fuel + 3kW PV + 5 kWh Battery</b>											
CZ01	PG&E	3,941	0	0.76	\$9,520	\$12,616	\$8,460	1.3	0.9	\$3,096	(\$1,060)
CZ02	PG&E	4,685	0	0.91	\$9,520	\$17,635	\$10,262	1.9	1.1	\$8,115	\$742
CZ03	PG&E	4,733	0	0.92	\$9,520	\$15,146	\$10,152	1.6	1.1	\$5,626	\$632
CZ04	PG&E	4,834	0	0.94	\$9,520	\$18,519	\$10,614	1.9	1.1	\$8,999	\$1,094
CZ04-2	CPAU	4,834	0	0.94	\$9,520	\$11,507	\$10,614	1.2	1.1	\$1,987	\$1,094
CZ05	PG&E	4,910	0	0.95	\$9,520	\$15,641	\$10,548	1.6	1.1	\$6,120	\$1,028
CZ05-2	SCG	4,910	0	0.95	\$9,520	\$15,641	\$10,548	1.6	1.1	\$6,120	\$1,028
CZ06	SCE	4,769	0	0.93	\$9,520	\$11,374	\$10,724	1.2	1.1	\$1,854	\$1,204
CZ06-2	LA	4,769	0	0.93	\$9,520	\$7,069	\$10,724	0.7	1.1	(\$2,452)	\$1,204
CZ07	SDG&E	4,960	0	0.96	\$9,520	\$22,452	\$11,031	2.4	1.2	\$12,932	\$1,511
CZ08	SCE	4,826	0	0.93	\$9,520	\$11,838	\$11,339	1.2	1.2	\$2,317	\$1,819
CZ08-2	LA	4,826	0	0.93	\$9,520	\$7,342	\$11,339	0.8	1.2	(\$2,178)	\$1,819
CZ09	SCE	4,889	0	0.96	\$9,520	\$11,187	\$11,229	1.2	1.2	\$1,667	\$1,709
CZ09-2	LA	4,889	0	0.96	\$9,520	\$6,728	\$11,229	0.7	1.2	(\$2,792)	\$1,709
CZ10	SDG&E	4,948	0	0.97	\$9,520	\$20,999	\$10,987	2.2	1.2	\$11,479	\$1,467
CZ10-2	SCE	4,948	0	0.97	\$9,520	\$11,384	\$10,987	1.2	1.2	\$1,863	\$1,467
CZ11	PG&E	4,718	0	0.91	\$9,520	\$15,381	\$10,680	1.6	1.1	\$5,861	\$1,160
CZ12	PG&E	4,707	0	0.91	\$9,520	\$16,442	\$10,614	1.7	1.1	\$6,922	\$1,094
CZ12-2	SMUD	4,707	0	0.91	\$9,520	\$8,247	\$10,614	0.9	1.1	(\$1,273)	\$1,094
CZ13	PG&E	4,750	0	0.92	\$9,520	\$16,638	\$10,592	1.7	1.1	\$7,117	\$1,072
CZ14	SDG&E	5,258	0	1.01	\$9,520	\$19,576	\$12,218	2.1	1.3	\$10,056	\$2,698
CZ14-2	SCE	5,258	0	1.01	\$9,520	\$10,227	\$12,218	1.1	1.3	\$707	\$2,698
CZ15	SCE	4,997	0	0.96	\$9,520	\$10,476	\$11,339	1.1	1.2	\$956	\$1,819
CZ16	PG&E	5,336	0	1.04	\$9,520	\$20,418	\$11,361	2.1	1.2	\$10,898	\$1,841
CZ16-2	LA	5,336	0	1.04	\$9,520	\$6,987	\$11,361	0.7	1.2	(\$2,533)	\$1,841



**Figure 64. Cost Effectiveness for Medium Retail – Mixed-Fuel + 110kW PV**

CZ	IOU territory	Elec Savings (kWh)	Gas Savings (therms)	GHG savings (tons)	Incremental Package Cost	Lifecycle Energy Cost Savings	Lifecycle TDV Savings	B/C Ratio (On-bill)	B/C Ratio (TDV)	NPV (On-bill)	NPV (TDV)
<b>Mixed Fuel + 110kW PV</b>											
CZ01	PG&E	144,499	0	27.97	\$201,904	\$454,462	\$309,935	2.3	1.5	\$252,558	\$108,031
CZ02	PG&E	171,790	0	33.31	\$201,904	\$477,584	\$376,300	2.4	1.9	\$275,681	\$174,396
CZ03	PG&E	173,534	0	33.55	\$201,904	\$538,530	\$372,146	2.7	1.8	\$336,626	\$170,243
CZ04	PG&E	177,229	0	34.42	\$201,904	\$489,934	\$389,067	2.4	1.9	\$288,030	\$187,163
CZ04-2	CPAU	177,229	0	34.42	\$201,904	\$418,173	\$389,067	2.1	1.9	\$216,269	\$187,163
CZ05	PG&E	180,044	0	34.84	\$201,904	\$556,787	\$386,958	2.8	1.9	\$354,883	\$185,054
CZ06	SCE	174,855	0	33.92	\$201,904	\$288,188	\$393,198	1.4	1.9	\$86,284	\$191,295
CZ06-2	LA	174,855	0	33.92	\$201,904	\$165,538	\$393,198	0.8	1.9	(\$36,366)	\$191,295
CZ07	SDG&E	181,854	0	35.32	\$201,904	\$373,974	\$404,713	1.9	2.0	\$172,070	\$202,809
CZ08	SCE	176,954	0	34.23	\$201,904	\$284,481	\$415,789	1.4	2.1	\$82,577	\$213,885
CZ08-2	LA	176,954	0	34.23	\$201,904	\$161,366	\$415,789	0.8	2.1	(\$40,538)	\$213,885
CZ09	SCE	179,267	0	35.18	\$201,904	\$289,050	\$412,097	1.4	2.0	\$87,146	\$210,193
CZ09-2	LA	179,267	0	35.18	\$201,904	\$168,822	\$412,097	0.8	2.0	(\$33,082)	\$210,193
CZ10	SDG&E	181,443	0	35.41	\$201,904	\$410,310	\$402,999	2.0	2.0	\$208,406	\$201,095
CZ10-2	SCE	181,443	0	35.41	\$201,904	\$291,236	\$402,999	1.4	2.0	\$89,332	\$201,095
CZ11	PG&E	172,983	0	33.46	\$201,904	\$464,776	\$391,550	2.3	1.9	\$262,872	\$189,646
CZ12	PG&E	172,597	0	33.33	\$201,904	\$467,870	\$389,573	2.3	1.9	\$265,966	\$187,669
CZ12-2	SMUD	172,597	0	33.33	\$201,904	\$267,086	\$389,573	1.3	1.9	\$65,182	\$187,669
CZ13	PG&E	174,151	0	33.81	\$201,904	\$478,857	\$387,968	2.4	1.9	\$276,953	\$186,065
CZ14	SDG&E	192,789	0	36.97	\$201,904	\$396,181	\$448,268	2.0	2.2	\$194,277	\$246,364
CZ14-2	SCE	192,789	0	36.97	\$201,904	\$288,782	\$448,268	1.4	2.2	\$86,878	\$246,364
CZ15	SCE	183,214	0	35.12	\$201,904	\$277,867	\$415,789	1.4	2.1	\$75,963	\$213,885
CZ16	PG&E	195,665	0	37.97	\$201,904	\$522,352	\$416,558	2.6	2.1	\$320,448	\$214,654
CZ16-2	LA	195,665	0	37.97	\$201,904	\$171,802	\$416,558	0.9	2.1	(\$30,101)	\$214,654



**Figure 65. Cost Effectiveness for Medium Retail – Mixed-Fuel + 110 kW PV + 50 kWh Battery**

CZ	IOU territory	Elec Savings (kWh)	Gas Savings (therms)	GHG savings (tons)	Incremental Package Cost	Lifecycle Energy Cost Savings	Lifecycle TDV Savings	B/C Ratio (On-bill)	B/C Ratio (TDV)	NPV (On-bill)	NPV (TDV)
<b>Mixed Fuel + 110kW PV + 50 kWh Battery</b>											
CZ01	PG&E	143,423	0	29.48	\$229,804	\$452,119	\$324,373	2.0	1.4	\$222,315	\$94,569
CZ02	PG&E	170,542	0	35.14	\$229,804	\$486,704	\$398,363	2.1	1.7	\$256,900	\$168,559
CZ03	PG&E	172,266	0	35.66	\$229,804	\$535,974	\$395,374	2.3	1.7	\$306,170	\$165,570
CZ04	PG&E	175,940	0	36.32	\$229,804	\$525,788	\$422,579	2.3	1.8	\$295,984	\$192,775
CZ04-2	CPAU	175,940	0	36.32	\$229,804	\$416,019	\$422,579	1.8	1.8	\$186,216	\$192,775
CZ05	PG&E	178,728	0	36.91	\$229,804	\$554,968	\$409,086	2.4	1.8	\$325,164	\$179,283
CZ06	SCE	173,567	0	35.99	\$229,804	\$290,599	\$412,690	1.3	1.8	\$60,795	\$182,886
CZ06-2	LA	173,567	0	35.99	\$229,804	\$169,786	\$412,690	0.7	1.8	(\$60,018)	\$182,886
CZ07	SDG&E	180,508	0	37.61	\$229,804	\$425,793	\$427,040	1.9	1.9	\$195,989	\$197,236
CZ08	SCE	175,616	0	36.29	\$229,804	\$296,318	\$434,687	1.3	1.9	\$66,514	\$204,883
CZ08-2	LA	175,616	0	36.29	\$229,804	\$170,489	\$434,687	0.7	1.9	(\$59,315)	\$204,883
CZ09	SCE	177,966	0	36.74	\$229,804	\$300,540	\$421,195	1.3	1.8	\$70,736	\$191,391
CZ09-2	LA	177,966	0	36.74	\$229,804	\$178,852	\$421,195	0.8	1.8	(\$50,952)	\$191,391
CZ10	SDG&E	180,248	0	36.91	\$229,804	\$459,486	\$410,537	2.0	1.8	\$229,683	\$180,733
CZ10-2	SCE	180,248	0	36.91	\$229,804	\$301,219	\$410,537	1.3	1.8	\$71,415	\$180,733
CZ11	PG&E	171,779	0	34.85	\$229,804	\$490,245	\$417,679	2.1	1.8	\$260,442	\$187,875
CZ12	PG&E	171,392	0	34.77	\$229,804	\$497,363	\$417,371	2.2	1.8	\$267,559	\$187,567
CZ12-2	SMUD	171,392	0	34.77	\$229,804	\$273,783	\$417,371	1.2	1.8	\$43,979	\$187,567
CZ13	PG&E	173,052	0	34.97	\$229,804	\$488,196	\$397,791	2.1	1.7	\$258,392	\$167,987
CZ14	SDG&E	191,703	0	38.31	\$229,804	\$420,241	\$452,641	1.8	2.0	\$190,437	\$222,837
CZ14-2	SCE	191,703	0	38.31	\$229,804	\$294,010	\$452,641	1.3	2.0	\$64,206	\$222,837
CZ15	SCE	182,299	0	36.01	\$229,804	\$279,036	\$416,382	1.2	1.8	\$49,232	\$186,578
CZ16	PG&E	194,293	0	40.00	\$229,804	\$535,137	\$432,951	2.3	1.9	\$305,333	\$203,147
CZ16-2	LA	194,293	0	40.00	\$229,804	\$175,573	\$432,951	0.8	1.9	(\$54,231)	\$203,147



**Figure 66. Cost Effectiveness for Medium Retail – All-Electric + 3kW PV**

CZ	IOU territory	Elec Savings (kWh)	Gas Savings (therms)	GHG savings (tons)	Incremental Package Cost	Lifecycle Energy Cost Savings	Lifecycle TDV Savings	B/C Ratio (On-bill)	B/C Ratio (TDV)	NPV (On-bill)	NPV (TDV)
<b>All-Electric + 3kW PV</b>											
CZ01	PG&E	-25,214	3893	14.61	(\$16,318)	\$4,288	(\$5,450)	>1	3.0	\$20,606	\$10,868
CZ02	PG&E	-17,101	2448	8.40	(\$20,734)	\$859	\$5,779	>1	>1	\$21,593	\$26,513
CZ03	PG&E	-9,851	1868	7.18	(\$17,381)	\$15,418	\$8,702	>1	>1	\$32,799	\$26,083
CZ04	PG&E	-9,353	1706	6.24	(\$16,166)	\$9,110	\$10,394	>1	>1	\$25,276	\$26,560
CZ04-2	CPAU	-9,353	1706	6.24	(\$16,166)	\$24,000	\$10,394	>1	>1	\$40,166	\$26,560
CZ05	PG&E	-9,423	1746	6.42	(\$18,776)	\$14,076	\$6,351	>1	>1	\$32,852	\$25,127
CZ06	SCE	-2,759	1002	4.24	(\$15,032)	\$29,710	\$12,592	>1	>1	\$44,741	\$27,623
CZ06-2	LA	-2,759	1002	4.24	(\$15,032)	\$26,292	\$12,592	>1	>1	\$41,324	\$27,623
CZ07	SDG&E	1,148	522	2.72	(\$17,032)	\$76,810	\$12,350	>1	>1	\$93,842	\$29,382
CZ08	SCE	-979	793	3.64	(\$20,192)	\$28,576	\$13,185	>1	>1	\$48,768	\$33,377
CZ08-2	LA	-979	793	3.64	(\$20,192)	\$24,475	\$13,185	>1	>1	\$44,667	\$33,377
CZ09	SCE	-2,352	970	4.28	(\$25,383)	\$29,776	\$13,207	>1	>1	\$55,159	\$38,590
CZ09-2	LA	-2,352	970	4.28	(\$25,383)	\$25,823	\$13,207	>1	>1	\$51,207	\$38,590
CZ10	SDG&E	-5,388	1262	4.95	(\$20,541)	\$75,458	\$11,493	>1	>1	\$95,999	\$32,034
CZ10-2	SCE	-5,388	1262	4.95	(\$20,541)	\$32,394	\$11,493	>1	>1	\$52,936	\$32,034
CZ11	PG&E	-14,533	2415	8.86	(\$25,471)	\$7,618	\$13,295	>1	>1	\$33,090	\$38,766
CZ12	PG&E	-14,764	2309	8.19	(\$25,774)	\$2,210	\$10,152	>1	>1	\$27,984	\$35,926
CZ12-2	SMUD	-14,764	2309	8.19	(\$25,774)	\$21,215	\$10,152	>1	>1	\$46,988	\$35,926
CZ13	PG&E	-12,069	1983	7.08	(\$21,428)	\$5,647	\$8,570	>1	>1	\$27,075	\$29,998
CZ14	SDG&E	-7,950	1672	6.45	(\$19,926)	\$60,412	\$16,679	>1	>1	\$80,338	\$36,605
CZ14-2	SCE	-7,950	1672	6.45	(\$19,926)	\$28,631	\$16,679	>1	>1	\$48,557	\$36,605
CZ15	SCE	2,534	518	3.10	(\$22,813)	\$27,271	\$17,162	>1	>1	\$50,084	\$39,976
CZ16	PG&E	-36,081	4304	14.26	(\$19,041)	(\$30,111)	(\$41,181)	0.6	0.5	(\$11,070)	(\$22,140)
CZ16-2	LA	-36,081	4304	14.26	(\$19,041)	\$45,706	(\$41,181)	>1	0.5	\$64,747	(\$22,140)



**Figure 67. Cost Effectiveness for Medium Retail - All-Electric + 3kW PV + 5 kWh Battery**

CZ	IOU territory	Elec Savings (kWh)	Gas Savings (therms)	GHG savings (tons)	Incremental Package Cost	Lifecycle Energy Cost Savings	-\$TDV Savings	B/C Ratio (On-bill)	B/C Ratio (TDV)	NPV (On-bill)	NPV (TDV)
<b>All-Electric + 3kW PV + 5 kWh Battery</b>											
CZ01	PG&E	-25,214	3893	14.61	(\$14,692)	\$4,288	(\$5,450)	>1	2.7	\$18,980	\$9,242
CZ02	PG&E	-17,101	2448	8.40	(\$14,692)	\$859	\$5,779	>1	>1	\$15,551	\$20,472
CZ03	PG&E	-9,851	1868	7.18	(\$14,692)	\$15,418	\$8,702	>1	>1	\$30,110	\$23,394
CZ04	PG&E	-9,353	1706	6.24	(\$14,692)	\$9,110	\$10,394	>1	>1	\$23,802	\$25,086
CZ04-2	CPAU	-9,353	1706	6.24	(\$14,692)	\$24,000	\$10,394	>1	>1	\$38,693	\$25,086
CZ05	PG&E	-9,423	1746	6.42	(\$14,692)	\$14,076	\$6,351	>1	>1	\$28,768	\$21,043
CZ06	SCE	-2,759	1002	4.24	(\$14,692)	\$29,710	\$12,592	>1	>1	\$44,402	\$27,284
CZ06-2	LA	-2,759	1002	4.24	(\$14,692)	\$26,292	\$12,592	>1	>1	\$40,984	\$27,284
CZ07	SDG&E	1,148	522	2.72	(\$14,692)	\$76,810	\$12,350	>1	>1	\$91,502	\$27,042
CZ08	SCE	-979	793	3.64	(\$14,692)	\$28,576	\$13,185	>1	>1	\$43,268	\$27,877
CZ08-2	LA	-979	793	3.64	(\$14,692)	\$24,475	\$13,185	>1	>1	\$39,167	\$27,877
CZ09	SCE	-2,352	970	4.28	(\$14,692)	\$29,776	\$13,207	>1	>1	\$44,468	\$27,899
CZ09-2	LA	-2,352	970	4.28	(\$14,692)	\$25,823	\$13,207	>1	>1	\$40,516	\$27,899
CZ10	SDG&E	-5,388	1262	4.95	(\$14,692)	\$75,458	\$11,493	>1	>1	\$90,150	\$26,185
CZ10-2	SCE	-5,388	1262	4.95	(\$14,692)	\$32,394	\$11,493	>1	>1	\$47,086	\$26,185
CZ11	PG&E	-14,533	2415	8.86	(\$14,692)	\$7,618	\$13,295	>1	>1	\$22,310	\$27,987
CZ12	PG&E	-14,764	2309	8.19	(\$14,692)	\$2,210	\$10,152	>1	>1	\$16,902	\$24,845
CZ12-2	SMUD	-14,764	2309	8.19	(\$14,692)	\$21,215	\$10,152	>1	>1	\$35,907	\$24,845
CZ13	PG&E	-12,069	1983	7.08	(\$14,692)	\$5,647	\$8,570	>1	>1	\$20,339	\$23,262
CZ14	SDG&E	-7,950	1672	6.45	(\$14,692)	\$60,412	\$16,679	>1	>1	\$75,104	\$31,371
CZ14-2	SCE	-7,950	1672	6.45	(\$14,692)	\$28,631	\$16,679	>1	>1	\$43,323	\$31,371
CZ15	SCE	2,534	518	3.10	(\$14,692)	\$27,271	\$17,162	>1	>1	\$41,963	\$31,855
CZ16	PG&E	-36,081	4304	14.26	(\$14,692)	(\$30,111)	(\$41,181)	0.5	0.4	(\$15,419)	(\$26,489)
CZ16-2	LA	-36,081	4304	14.26	(\$14,692)	\$45,706	(\$41,181)	>1	0.4	\$60,398	(\$26,489)





**Figure 68. Cost Effectiveness for Medium Retail – All-Electric + 110kW PV**

CZ	IOU territory	Elec Savings (kWh)	Gas Savings (therms)	GHG savings (tons)	Incremental Package Cost	Lifecycle Energy Cost Savings	Lifecycle TDV Savings	B/C Ratio (On-bill)	B/C Ratio (TDV)	NPV (On-bill)	NPV (TDV)
<b>All-Electric + 110kW PV</b>											
CZ01	PG&E	115,344	3893	41.82	\$143,932	\$454,277	\$296,025	3.2	2.1	\$310,345	\$152,093
CZ02	PG&E	150,004	2448	40.80	\$139,516	\$470,236	\$371,817	3.4	2.7	\$330,720	\$232,301
CZ03	PG&E	158,951	1868	39.82	\$142,869	\$544,095	\$370,696	3.8	2.6	\$401,226	\$227,827
CZ04	PG&E	163,043	1706	39.73	\$144,084	\$488,619	\$388,847	3.4	2.7	\$344,534	\$244,763
CZ04-2	CPAU	163,043	1706	39.73	\$144,084	\$432,905	\$388,847	3.0	2.7	\$288,821	\$244,763
CZ05	PG&E	165,711	1746	40.30	\$141,473	\$565,525	\$382,760	4.0	2.7	\$424,051	\$241,287
CZ06	SCE	167,328	1002	37.24	\$145,218	\$306,670	\$395,066	2.1	2.7	\$161,452	\$249,848
CZ06-2	LA	167,328	1002	37.24	\$145,218	\$184,797	\$395,066	1.3	2.7	\$39,579	\$249,848
CZ07	SDG&E	178,042	522	37.07	\$143,218	\$428,332	\$406,032	3.0	2.8	\$285,114	\$262,814
CZ08	SCE	171,149	793	36.94	\$140,058	\$301,219	\$417,635	2.2	3.0	\$161,161	\$277,577
CZ08-2	LA	171,149	793	36.94	\$140,058	\$178,419	\$417,635	1.3	3.0	\$38,361	\$277,577
CZ09	SCE	172,027	970	38.50	\$134,867	\$307,640	\$414,075	2.3	3.1	\$172,773	\$279,208
CZ09-2	LA	172,027	970	38.50	\$134,867	\$187,813	\$414,075	1.4	3.1	\$52,946	\$279,208
CZ10	SDG&E	171,107	1262	39.40	\$139,708	\$463,692	\$403,505	3.3	2.9	\$323,984	\$263,796
CZ10-2	SCE	171,107	1262	39.40	\$139,708	\$311,464	\$403,505	2.2	2.9	\$171,755	\$263,796
CZ11	PG&E	153,732	2415	41.41	\$134,778	\$467,356	\$394,165	3.5	2.9	\$332,578	\$259,387
CZ12	PG&E	153,126	2309	40.61	\$134,476	\$467,106	\$389,111	3.5	2.9	\$332,630	\$254,635
CZ12-2	SMUD	153,126	2309	40.61	\$134,476	\$283,343	\$389,111	2.1	2.9	\$148,867	\$254,635
CZ13	PG&E	157,332	1983	39.97	\$138,822	\$477,831	\$385,947	3.4	2.8	\$339,008	\$247,124
CZ14	SDG&E	179,582	1672	42.42	\$140,324	\$437,575	\$452,729	3.1	3.2	\$297,251	\$312,405
CZ14-2	SCE	179,582	1672	42.42	\$140,324	\$309,064	\$452,729	2.2	3.2	\$168,740	\$312,405
CZ15	SCE	180,751	518	37.26	\$137,436	\$294,877	\$421,612	2.1	3.1	\$157,440	\$284,176
CZ16	PG&E	154,248	4304	51.20	\$141,209	\$473,892	\$364,016	3.4	2.6	\$332,682	\$222,807
CZ16-2	LA	154,248	4304	51.20	\$141,209	\$211,677	\$364,016	1.5	2.6	\$70,467	\$222,807



**Figure 69. Cost Effectiveness for Medium Retail – All-Electric + 110kW PV + 50 kWh Battery**

CZ	IOU territory	Elec Savings (kWh)	Gas Savings (therms)	GHG savings (tons)	Incremental Package Cost	Lifecycle Energy Cost Savings	Lifecycle TDV Savings	B/C Ratio (On-bill)	B/C Ratio (TDV)	NPV (On-bill)	NPV (TDV)
<b>All-Electric + 90kW PV + 50 kWh Battery</b>											
CZ01	PG&E	114,356	3893	43.52	\$171,832	\$451,043	\$310,265	2.6	1.8	\$279,211	\$138,433
CZ02	PG&E	148,793	2448	42.89	\$167,416	\$475,081	\$394,099	2.8	2.4	\$307,664	\$226,683
CZ03	PG&E	157,707	1868	42.12	\$170,769	\$541,418	\$394,034	3.2	2.3	\$370,649	\$223,265
CZ04	PG&E	161,769	1706	41.82	\$171,984	\$523,603	\$422,535	3.0	2.5	\$351,618	\$250,551
CZ04-2	CPAU	161,769	1706	41.82	\$171,984	\$430,567	\$422,535	2.5	2.5	\$258,582	\$250,551
CZ05	PG&E	164,408	1746	42.68	\$169,373	\$561,966	\$405,087	3.3	2.4	\$392,592	\$235,714
CZ06	SCE	166,052	1002	39.48	\$173,118	\$306,697	\$414,756	1.8	2.4	\$133,579	\$241,638
CZ06-2	LA	166,052	1002	39.48	\$173,118	\$187,941	\$414,756	1.1	2.4	\$14,823	\$241,638
CZ07	SDG&E	176,705	522	39.47	\$171,118	\$479,038	\$428,490	2.8	2.5	\$307,920	\$257,372
CZ08	SCE	169,825	793	39.14	\$167,958	\$312,602	\$436,709	1.9	2.6	\$144,645	\$268,751
CZ08-2	LA	169,825	793	39.14	\$167,958	\$187,142	\$436,709	1.1	2.6	\$19,185	\$268,751
CZ09	SCE	170,747	970	40.23	\$162,767	\$318,113	\$423,370	2.0	2.6	\$155,346	\$260,604
CZ09-2	LA	170,747	970	40.23	\$162,767	\$197,006	\$423,370	1.2	2.6	\$34,240	\$260,604
CZ10	SDG&E	169,935	1262	41.08	\$167,608	\$503,504	\$411,284	3.0	2.5	\$335,896	\$243,675
CZ10-2	SCE	169,935	1262	41.08	\$167,608	\$317,927	\$411,284	1.9	2.5	\$150,319	\$243,675
CZ11	PG&E	152,559	2415	42.99	\$162,678	\$491,775	\$420,667	3.0	2.6	\$329,096	\$257,989
CZ12	PG&E	151,956	2309	42.21	\$162,376	\$494,703	\$417,063	3.0	2.6	\$332,327	\$254,687
CZ12-2	SMUD	151,956	2309	42.21	\$162,376	\$288,950	\$417,063	1.8	2.6	\$126,573	\$254,687
CZ13	PG&E	156,271	1983	41.25	\$166,722	\$485,422	\$395,770	2.9	2.4	\$318,699	\$229,047
CZ14	SDG&E	178,505	1672	43.94	\$168,224	\$452,456	\$457,387	2.7	2.7	\$284,232	\$289,163
CZ14-2	SCE	178,505	1672	43.94	\$168,224	\$311,520	\$457,387	1.9	2.7	\$143,296	\$289,163
CZ15	SCE	179,840	518	38.23	\$165,336	\$296,004	\$422,293	1.8	2.6	\$130,668	\$256,957
CZ16	PG&E	152,965	4304	53.53	\$169,109	\$483,205	\$378,299	2.9	2.2	\$314,096	\$209,190
CZ16-2	LA	152,965	4304	53.53	\$169,109	\$215,341	\$378,299	1.3	2.2	\$46,231	\$209,190



### 6.7.3 Cost Effectiveness Results – Small Hotel

Figure 70 through Figure 77 contain the cost-effectiveness findings for the Small Hotel packages. Notable findings for each package include:

- ◆ **Mixed-Fuel + 3 kW PV:** Packages are cost effective and achieve savings for all climate zones for both the On-Bill and TDV approaches.
- ◆ **Mixed-Fuel + 3 kW PV + 5 kWh Battery:** The packages are less cost effective as compared to the previous minimal PV only package and not cost effective for LADWP and SMUD service area. The addition of battery reduces the cost effectiveness of packages.
- ◆ **Mixed-Fuel + PV only:** Packages are cost effective and achieve savings for the On-Bill approach for all climate zones except for LADWP territory. Packages are cost effective and achieve savings for the TDV approach for all climate zones.
- ◆ **Mixed-Fuel + PV + 50 kWh Battery:** Adding battery slightly reduces On-Bill B/C ratios. Packages are not cost effective for LADWP territory, SMUD territory as well as for climate zones 6,8,9 under PG&E service area.
- ◆ **All-Electric + 3 kW PV:** All packages are cost effective using the On-Bill approach. All packages are cost effective using the TDV approach but do not achieve positive energy cost savings.
- ◆ **All-Electric + 3 kW PV + 5 kWh Battery:** Similar to minimal PV only package, all packages are cost effective using the On-Bill approach. All packages are cost effective using the TDV approach but do not achieve positive energy cost savings.
- ◆ **All-Electric + PV only:** All packages are cost effective for both On-Bill and TDV approaches. Packages achieve on-bill savings for all climate zones.
- ◆ **All-Electric + PV + 50 kWh Battery:** Adding battery slightly reduces On-Bill B/C ratios but is still cost effective for all climate zones.



**Figure 70. Cost Effectiveness for Small Hotel – Mixed Fuel + 3kW PV**

CZ	IOU territory	Elec Savings (kWh)	Gas Savings (therms)	GHG savings (tons)	Incremental Package Cost	Lifecycle Energy Cost Savings	Lifecycle \$-TDV Savings	B/C Ratio (On-bill)	B/C Ratio (TDV)	NPV (On-bill)	NPV (TDV)
<b>Mixed Fuel + 3kW PV</b>											
CZ01	PG&E	3,941	0	0.8	\$5,566	\$12,616	\$8,326	2.3	1.5	\$7,050	\$2,760
CZ02	PG&E	4,785	0	0.9	\$5,566	\$12,639	\$10,332	2.3	1.9	\$7,073	\$4,766
CZ03	PG&E	4,733	0	0.9	\$5,566	\$15,146	\$9,991	2.7	1.8	\$9,580	\$4,425
CZ04	PG&E	4,834	0	1.0	\$5,566	\$13,266	\$10,445	2.4	1.9	\$7,700	\$4,879
CZ04-2	CPAU	4,834	0	1.0	\$5,566	\$11,507	\$10,445	2.1	1.9	\$5,941	\$4,879
CZ05	PG&E	5,027	0	1.0	\$5,566	\$16,048	\$10,634	2.9	1.9	\$10,482	\$5,068
CZ06	SCE	4,769	0	0.9	\$5,566	\$10,276	\$10,559	1.8	1.9	\$4,710	\$4,993
CZ06-2	LA	4,769	0	0.9	\$5,566	\$6,307	\$10,559	1.1	1.9	\$741	\$4,993
CZ07	SDG&E	4,960	0	1.0	\$5,566	\$14,576	\$10,861	2.6	2.0	\$9,010	\$5,295
CZ08	SCE	4,824	0	0.9	\$5,566	\$10,837	\$11,202	1.9	2.0	\$5,271	\$5,636
CZ08-2	LA	4,824	0	0.9	\$5,566	\$6,505	\$11,202	1.2	2.0	\$939	\$5,636
CZ09	SCE	4,779	0	0.9	\$5,566	\$10,298	\$10,824	1.9	1.9	\$4,732	\$5,258
CZ09-2	LA	4,779	0	0.9	\$5,566	\$6,201	\$10,824	1.1	1.9	\$635	\$5,258
CZ10	SDG&E	4,905	0	1.0	\$5,566	\$16,302	\$10,710	2.9	1.9	\$10,736	\$5,144
CZ10-2	SCE	4,905	0	1.0	\$5,566	\$9,468	\$10,710	1.7	1.9	\$3,902	\$5,144
CZ11	PG&E	4,701	0	0.9	\$5,566	\$14,193	\$10,483	2.6	1.9	\$8,627	\$4,917
CZ12	PG&E	4,770	0	0.9	\$5,566	\$15,262	\$10,596	2.7	1.9	\$9,696	\$5,030
CZ12-2	SMUD	4,770	0	0.9	\$5,566	\$7,848	\$10,596	1.4	1.9	\$2,282	\$5,030
CZ13	PG&E	4,633	0	0.9	\$5,566	\$14,674	\$10,105	2.6	1.8	\$9,108	\$4,539
CZ14	SDG&E	5,377	0	1.1	\$5,566	\$16,615	\$12,375	3.0	2.2	\$11,049	\$6,809
CZ14-2	SCE	5,377	0	1.1	\$5,566	\$10,021	\$12,375	1.8	2.2	\$4,455	\$6,809
CZ15	SCE	4,997	0	1.0	\$5,566	\$9,542	\$11,164	1.7	2.0	\$3,976	\$5,598
CZ16	PG&E	5,240	0	1.0	\$5,566	\$14,961	\$10,975	2.7	2.0	\$9,395	\$5,409
CZ16-2	LA	5,240	0	1.0	\$5,566	\$5,670	\$10,975	1.0	2.0	\$104	\$5,409



**Figure 71. Cost Effectiveness for Small Hotel – Mixed Fuel + 3kW PV + 5 kWh Battery**

CZ	IOU territory	Elec Savings (kWh)	Gas Savings (therms)	GHG savings (tons)	Incremental Package Cost	Lifecycle Energy Cost Savings	-\$TDV Savings	B/C Ratio (On-bill)	B/C Ratio (TDV)	NPV (On-bill)	NPV (TDV)
<b>Mixed Fuel + 3kW PV + 5kWh Battery</b>											
CZ01	PG&E	3,941	0	0.8	\$9,520	\$12,616	\$8,326	1.3	0.9	\$3,096	(\$1,194)
CZ02	PG&E	4,785	0	0.9	\$9,520	\$12,639	\$10,332	1.3	1.1	\$3,119	\$811
CZ03	PG&E	4,733	0	0.9	\$9,520	\$15,146	\$9,991	1.6	1.0	\$5,626	\$471
CZ04	PG&E	4,834	0	1.0	\$9,520	\$13,266	\$10,445	1.4	1.1	\$3,746	\$925
CZ04-2	CPAU	4,834	0	1.0	\$9,520	\$11,507	\$10,445	1.2	1.1	\$1,987	\$925
CZ05	PG&E	5,027	0	1.0	\$9,520	\$16,048	\$10,634	1.7	1.1	\$6,528	\$1,114
CZ05-2	SCG	5,027	0	1.0	\$9,520	\$16,048	\$10,634	1.7	1.1	\$6,528	\$1,114
CZ06	SCE	4,769	0	0.9	\$9,520	\$10,276	\$10,559	1.1	1.1	\$756	\$1,039
CZ06-2	LA	4,769	0	0.9	\$9,520	\$6,307	\$10,559	0.7	1.1	(\$3,213)	\$1,039
CZ07	SDG&E	4,960	0	1.0	\$9,520	\$14,576	\$10,861	1.5	1.1	\$5,056	\$1,341
CZ08	SCE	4,824	0	0.9	\$9,520	\$10,837	\$11,202	1.1	1.2	\$1,317	\$1,682
CZ08-2	LA	4,824	0	0.9	\$9,520	\$6,505	\$11,202	0.7	1.2	(\$3,015)	\$1,682
CZ09	SCE	4,779	0	0.9	\$9,520	\$10,298	\$10,824	1.1	1.1	\$778	\$1,303
CZ09-2	LA	4,779	0	0.9	\$9,520	\$6,201	\$10,824	0.7	1.1	(\$3,319)	\$1,303
CZ10	SDG&E	4,905	0	1.0	\$9,520	\$16,302	\$10,710	1.7	1.1	\$6,782	\$1,190
CZ10-2	SCE	4,905	0	1.0	\$9,520	\$9,468	\$10,710	0.99	1.1	(\$52)	\$1,190
CZ11	PG&E	4,701	0	0.9	\$9,520	\$14,193	\$10,483	1.5	1.1	\$4,673	\$963
CZ12	PG&E	4,770	0	0.9	\$9,520	\$15,262	\$10,596	1.6	1.1	\$5,742	\$1,076
CZ12-2	SMUD	4,770	0	0.9	\$9,520	\$7,848	\$10,596	0.8	1.1	(\$1,672)	\$1,076
CZ13	PG&E	4,633	0	0.9	\$9,520	\$14,674	\$10,105	1.5	1.1	\$5,154	\$584
CZ14	SDG&E	5,377	0	1.1	\$9,520	\$16,615	\$12,375	1.7	1.3	\$7,095	\$2,855
CZ14-2	SCE	5,377	0	1.1	\$9,520	\$10,021	\$12,375	1.1	1.3	\$501	\$2,855
CZ15	SCE	4,997	0	1.0	\$9,520	\$9,542	\$11,164	1.0	1.2	\$22	\$1,644
CZ16	PG&E	5,240	0	1.0	\$9,520	\$14,961	\$10,975	1.6	1.2	\$5,441	\$1,455
CZ16-2	LA	5,240	0	1.0	\$9,520	\$5,670	\$10,975	0.6	1.2	(\$3,851)	\$1,455



**Figure 72. Cost Effectiveness for Small Hotel - Mixed Fuel +80kW PV**

CZ	IOU territory	Elec Savings (kWh)	Gas Savings (therms)	GHG savings (tons)	Incremental Package Cost	Lifecycle Energy Cost Savings	Lifecycle TDV Savings	B/C Ratio (On-bill)	B/C Ratio (TDV)	NPV (On-bill)	NPV (TDV)
<b>Mixed Fuel + 80kW PV</b>											
CZ01	PG&E	105,090	0	20.6	\$179,470	\$336,440	\$221,883	1.9	1.2	\$156,970	\$42,413
CZ02	PG&E	127,592	0	25.0	\$179,470	\$320,009	\$275,130	1.8	1.5	\$140,539	\$95,660
CZ03	PG&E	126,206	0	24.8	\$179,470	\$403,900	\$266,426	2.3	1.5	\$224,430	\$86,956
CZ04	PG&E	128,894	0	25.4	\$179,470	\$322,782	\$278,536	1.8	1.6	\$143,312	\$99,066
CZ04-2	CPAU	128,894	0	25.4	\$179,470	\$306,862	\$278,536	1.7	1.6	\$127,392	\$99,066
CZ05	PG&E	134,041	0	26.5	\$179,470	\$427,935	\$283,834	2.4	1.6	\$248,465	\$104,364
CZ06	SCE	127,168	0	25.0	\$179,470	\$200,425	\$281,488	1.1	1.6	\$20,955	\$102,018
CZ06-2	LA	127,168	0	25.0	\$179,470	\$119,357	\$281,488	0.7	1.6	(\$60,113)	\$102,018
CZ07	SDG&E	132,258	0	26.1	\$179,470	\$247,646	\$289,700	1.4	1.6	\$68,176	\$110,230
CZ08	SCE	128,641	0	25.3	\$179,470	\$207,993	\$298,594	1.2	1.7	\$28,523	\$119,124
CZ08-2	LA	128,641	0	25.3	\$179,470	\$122,591	\$298,594	0.7	1.7	(\$56,879)	\$119,124
CZ09	SCE	127,447	0	25.3	\$179,470	\$211,567	\$288,830	1.2	1.6	\$32,096	\$109,360
CZ09-2	LA	127,447	0	25.3	\$179,470	\$123,486	\$288,830	0.7	1.6	(\$55,984)	\$109,360
CZ10	SDG&E	130,792	0	25.8	\$179,470	\$274,832	\$285,386	1.5	1.6	\$95,361	\$105,916
CZ10-2	SCE	130,792	0	25.8	\$179,470	\$206,865	\$285,386	1.2	1.6	\$27,395	\$105,916
CZ11	PG&E	125,366	0	24.6	\$179,470	\$316,781	\$279,331	1.8	1.6	\$137,311	\$99,861
CZ12	PG&E	127,203	0	25.0	\$179,470	\$406,977	\$282,358	2.3	1.6	\$227,507	\$102,888
CZ12-2	SMUD	127,203	0	25.0	\$179,470	\$198,254	\$282,358	1.1	1.6	\$18,784	\$102,888
CZ13	PG&E	123,535	0	24.4	\$179,470	\$317,261	\$269,908	1.8	1.5	\$137,791	\$90,437
CZ14	SDG&E	143,387	0	28.1	\$179,470	\$309,521	\$330,345	1.7	1.8	\$130,051	\$150,875
CZ14-2	SCE	143,387	0	28.1	\$179,470	\$225,083	\$330,345	1.3	1.8	\$45,612	\$150,875
CZ15	SCE	133,246	0	25.9	\$179,470	\$207,277	\$297,648	1.2	1.7	\$27,807	\$118,177
CZ16	PG&E	139,738	0	27.3	\$179,470	\$341,724	\$292,728	1.9	1.6	\$162,254	\$113,258
CZ16-2	LA	139,738	0	27.3	\$179,470	\$114,215	\$292,728	0.6	1.6	(\$65,255)	\$113,258



**Figure 73. Cost Effectiveness for Small Hotel – Mixed Fuel + 80kW PV + 50 kWh Battery**

CZ	IOU territory	Elec Savings (kWh)	Gas Savings (therms)	GHG savings (tons)	Incremental Package Cost	Lifecycle Energy Cost Savings	Lifecycle TDV Savings	B/C Ratio (On-bill)	B/C Ratio (TDV)	NPV (On-bill)	NPV (TDV)
<b>Mixed Fuel + 80kW PV + 50kWh Battery</b>											
CZ01	PG&E	104,026	0	23.2	\$207,370	\$332,596	\$237,740	1.6	1.1	\$125,226	\$30,370
CZ02	PG&E	126,332	0	28.1	\$207,370	\$336,179	\$296,058	1.6	1.4	\$128,809	\$88,688
CZ03	PG&E	124,934	0	28.0	\$207,370	\$399,220	\$289,360	1.9	1.4	\$191,850	\$81,990
CZ04	PG&E	127,602	0	28.5	\$207,370	\$332,161	\$308,887	1.6	1.5	\$124,790	\$101,517
CZ04-2	CPAU	127,602	0	28.5	\$207,370	\$303,828	\$308,887	1.5	1.5	\$96,458	\$101,517
CZ05	PG&E	132,725	0	29.8	\$207,370	\$423,129	\$303,627	2.0	1.5	\$215,758	\$96,257
CZ06	SCE	125,880	0	28.4	\$207,370	\$193,814	\$297,950	0.9	1.4	(\$13,556)	\$90,580
CZ06-2	LA	125,880	0	28.4	\$207,370	\$123,083	\$297,950	0.6	1.4	(\$84,287)	\$90,580
CZ07	SDG&E	130,940	0	29.5	\$207,370	\$274,313	\$309,682	1.3	1.5	\$66,943	\$102,312
CZ08	SCE	127,332	0	28.5	\$207,370	\$199,786	\$312,899	1.0	1.5	(\$7,584)	\$105,529
CZ08-2	LA	127,332	0	28.5	\$207,370	\$124,651	\$312,899	0.6	1.5	(\$82,719)	\$105,529
CZ09	SCE	126,232	0	28.2	\$207,370	\$206,706	\$292,804	1.0	1.4	(\$664)	\$85,433
CZ09-2	LA	126,232	0	28.2	\$207,370	\$126,710	\$292,804	0.6	1.4	(\$80,660)	\$85,433
CZ10	SDG&E	129,683	0	28.4	\$207,370	\$292,202	\$287,278	1.4	1.4	\$84,832	\$79,908
CZ10-2	SCE	129,683	0	28.4	\$207,370	\$206,171	\$287,278	1.0	1.4	(\$1,199)	\$79,908
CZ11	PG&E	124,337	0	26.9	\$207,370	\$315,330	\$283,683	1.5	1.4	\$107,960	\$76,313
CZ12	PG&E	126,013	0	27.8	\$207,370	\$403,127	\$297,118	1.9	1.4	\$195,757	\$89,748
CZ12-2	SMUD	126,013	0	27.8	\$207,370	\$198,007	\$297,118	1.0	1.4	(\$9,363)	\$89,748
CZ13	PG&E	122,591	0	26.5	\$207,370	\$315,541	\$280,996	1.5	1.4	\$108,171	\$73,626
CZ14	SDG&E	142,257	0	30.7	\$207,370	\$317,565	\$334,697	1.5	1.6	\$110,195	\$127,327
CZ14-2	SCE	142,257	0	30.7	\$207,370	\$224,195	\$334,697	1.1	1.6	\$16,824	\$127,327
CZ15	SCE	132,418	0	27.8	\$207,370	\$208,044	\$299,199	1.0	1.4	\$674	\$91,829
CZ16	PG&E	138,402	0	30.7	\$207,370	\$358,582	\$315,699	1.7	1.5	\$151,212	\$108,329
CZ16-2	LA	138,402	0	30.7	\$207,370	\$118,770	\$315,699	0.6	1.5	(\$88,600)	\$108,329



**Figure 74. Cost Effectiveness for Small Hotel – All-Electric + 3kW PV**

CZ	IOU territory	Elec Savings (kWh)	Gas Savings (therms)	GHG savings (tons)	Incremental Package Cost*	Lifecycle Energy Cost Savings	Lifecycle TDV Savings	B/C Ratio (On-bill)	B/C Ratio (TDV)	NPV (On-bill)	NPV (TDV)
<b>All-Electric + 3kW PV</b>											
CZ01	PG&E	-155,861	16917	54.7	(\$1,265,139)	(\$568,892)	(\$106,835)	2.2	11.8	\$696,246	\$1,158,304
CZ02	PG&E	-113,954	12677	40.9	(\$1,266,111)	(\$229,433)	(\$41,288)	5.5	30.7	\$1,036,679	\$1,224,823
CZ03	PG&E	-105,862	12322	41.4	(\$1,268,383)	(\$309,874)	(\$41,175)	4.1	30.8	\$958,510	\$1,227,208
CZ04	PG&E	-108,570	11927	37.5	(\$1,268,218)	(\$208,239)	(\$42,689)	6.1	29.7	\$1,059,980	\$1,225,530
CZ04-2	CPAU	-108,570	11927	37.5	(\$1,268,218)	(\$6,261)	(\$42,689)	202.6	29.7	\$1,261,958	\$1,225,530
CZ05	PG&E	-103,579	11960	39.3	(\$1,268,272)	(\$332,879)	(\$44,051)	3.8	28.8	\$935,393	\$1,224,221
CZ06	SCE	-73,524	8912	30.3	(\$1,268,413)	\$48,898	(\$17,484)	>1	72.5	\$1,317,311	\$1,250,929
CZ06-2	LA	-64,859	8188	29.0	(\$1,266,760)	(\$120,842)	(\$12,337)	10.5	102.7	\$1,145,918	\$1,254,423
CZ07	SDG&E	-67,090	8353	29.2	(\$1,264,731)	(\$43,964)	(\$11,618)	28.8	108.9	\$1,220,767	\$1,253,113
CZ08	SCE	-67,090	8353	29.2	(\$1,264,731)	\$48,736	(\$11,618)	>1	108.9	\$1,313,467	\$1,253,113
CZ08-2	LA	-67,483	8402	29.3	(\$1,266,529)	(\$35,547)	(\$11,126)	35.6	113.8	\$1,230,982	\$1,255,403
CZ09	SCE	-67,483	8402	29.3	(\$1,266,529)	\$52,410	(\$11,126)	>1	113.8	\$1,318,939	\$1,255,403
CZ09-2	LA	-75,157	8418	27.2	(\$1,263,531)	(\$156,973)	(\$25,469)	8.0	49.6	\$1,106,558	\$1,238,061
CZ10	SDG&E	-75,157	8418	27.2	(\$1,263,531)	(\$54,711)	(\$25,469)	23.1	49.6	\$1,208,820	\$1,238,061
CZ10-2	SCE	-94,783	10252	31.9	(\$1,264,340)	(\$169,847)	(\$38,904)	7.4	32.5	\$1,094,493	\$1,225,436
CZ11	PG&E	-94,702	10403	33.0	(\$1,265,779)	(\$324,908)	(\$34,968)	3.9	36.2	\$940,872	\$1,230,811
CZ12	PG&E	-94,297	10403	33.1	(\$1,265,779)	\$13,603	(\$33,757)	>1	37.5	\$1,279,382	\$1,232,022
CZ12-2	SMUD	-92,196	10029	31.5	(\$1,264,152)	(\$168,358)	(\$40,229)	7.5	31.4	\$1,095,794	\$1,223,923
CZ13	PG&E	-96,021	10056	30.7	(\$1,264,510)	(\$308,542)	(\$44,202)	4.1	28.6	\$955,969	\$1,220,308
CZ14	SDG&E	-96,021	10056	30.7	(\$1,264,510)	(\$110,730)	(\$44,202)	11.4	28.6	\$1,153,780	\$1,220,308
CZ14-2	SCE	-44,856	5579	19.0	(\$1,262,631)	\$8,996	(\$10,256)	>1	123.1	\$1,271,627	\$1,252,375
CZ15	SCE	-211,468	17599	42.9	(\$1,268,907)	(\$625,671)	(\$228,203)	2.0	5.6	\$643,236	\$1,040,704
CZ16	PG&E	-211,468	17599	42.9	(\$1,268,907)	\$37,142	(\$228,203)	>1	5.6	\$1,306,049	\$1,040,704
CZ16-2	LA	-155,861	16917	54.7	(\$1,265,139)	(\$568,892)	(\$106,835)	2.2	11.8	\$696,246	\$1,158,304





**Figure 75. Cost Effectiveness for Small Hotel – All-Electric + 3kW PV + 5 kWh Battery**

CZ	IOU territory	Elec Savings (kWh)	Gas Savings (therms)	GHG savings (tons)	Incremental Package Cost	Lifecycle Energy Cost Savings	-\$TDV Savings	B/C Ratio (On-bill)	B/C Ratio (TDV)	NPV (On-bill)	NPV (TDV)
<b>All-Electric + 3kW PV + 5kWh Battery</b>											
CZ01	PG&E	-155,861	16917	54.7	(\$1,288,428)	(\$568,892)	(\$106,835)	2.3	12.1	\$719,536	\$1,181,593
CZ02	PG&E	-113,954	12677	40.9	(\$1,288,428)	(\$229,433)	(\$41,288)	5.6	31.2	\$1,058,996	\$1,247,140
CZ03	PG&E	-105,862	12322	41.4	(\$1,288,428)	(\$309,874)	(\$41,175)	4.2	31.3	\$978,554	\$1,247,253
CZ04	PG&E	-108,570	11927	37.5	(\$1,288,428)	(\$208,239)	(\$42,689)	6.2	30.2	\$1,080,190	\$1,245,740
CZ04-2	CPAU	-108,570	11927	37.5	(\$1,288,428)	(\$6,261)	(\$42,689)	205.8	30.2	\$1,282,167	\$1,245,740
CZ05	PG&E	-103,579	11960	39.3	(\$1,288,428)	(\$332,879)	(\$44,051)	3.9	29.2	\$955,549	\$1,244,377
CZ06	SCE	-73,524	8912	30.3	(\$1,288,428)	(\$52,341)	(\$17,484)	24.6	73.7	\$1,236,087	\$1,270,944
CZ06-2	LA	-73,524	8912	30.3	(\$1,288,428)	\$48,898	(\$17,484)	>1	73.7	\$1,337,326	\$1,270,944
CZ07	SDG&E	-64,859	8188	29.0	(\$1,288,428)	(\$120,842)	(\$12,337)	10.7	104.4	\$1,167,586	\$1,276,091
CZ08	SCE	-67,090	8353	29.2	(\$1,288,428)	(\$43,964)	(\$11,618)	29.3	110.9	\$1,244,464	\$1,276,810
CZ08-2	LA	-67,090	8353	29.2	(\$1,288,428)	\$48,736	(\$11,618)	>1	110.9	\$1,337,164	\$1,276,810
CZ09	SCE	-67,483	8402	29.3	(\$1,288,428)	(\$35,547)	(\$11,126)	36.2	115.8	\$1,252,881	\$1,277,302
CZ09-2	LA	-67,483	8402	29.3	(\$1,288,428)	\$52,410	(\$11,126)	>1	115.8	\$1,340,838	\$1,277,302
CZ10	SDG&E	-75,157	8418	27.2	(\$1,288,428)	(\$156,973)	(\$25,469)	8.2	50.6	\$1,131,455	\$1,262,959
CZ10-2	SCE	-75,157	8418	27.2	(\$1,288,428)	(\$54,711)	(\$25,469)	23.5	50.6	\$1,233,718	\$1,262,959
CZ11	PG&E	-94,783	10252	31.9	(\$1,288,428)	(\$169,847)	(\$38,904)	7.6	33.1	\$1,118,582	\$1,249,524
CZ12	PG&E	-94,702	10403	33.0	(\$1,288,428)	(\$324,908)	(\$34,968)	4.0	36.8	\$963,520	\$1,253,460
CZ12-2	SMUD	-94,297	10403	33.1	(\$1,288,428)	\$13,603	(\$33,757)	>1	38.2	\$1,302,031	\$1,254,671
CZ13	PG&E	-92,196	10029	31.5	(\$1,288,428)	(\$168,358)	(\$40,229)	7.7	32.0	\$1,120,071	\$1,248,199
CZ14	SDG&E	-96,021	10056	30.7	(\$1,288,428)	(\$308,542)	(\$44,202)	4.2	29.1	\$979,887	\$1,244,226
CZ14-2	SCE	-96,021	10056	30.7	(\$1,288,428)	(\$110,730)	(\$44,202)	11.6	29.1	\$1,177,698	\$1,244,226
CZ15	SCE	-44,856	5579	19.0	(\$1,288,428)	\$8,996	(\$10,256)	>1	125.6	\$1,297,425	\$1,278,172
CZ16	PG&E	-211,468	17599	42.9	(\$1,288,428)	(\$625,671)	(\$228,203)	2.1	5.6	\$662,757	\$1,060,225
CZ16-2	LA	-211,468	17599	42.9	(\$1,288,428)	\$37,142	(\$228,203)	>1	5.6	\$1,325,570	\$1,060,225



**Figure 76. Cost Effectiveness for Small Hotel – All-Electric + 80kW PV**

CZ	IOU territory	Elec Savings (kWh)	Gas Savings (therms)	GHG savings (tons)	Incremental Package Cost	Lifecycle Energy Cost Savings	-\$TDV Savings	B/C Ratio (On-bill)	B/C Ratio (TDV)	NPV (On-bill)	NPV (TDV)
<b>All-Electric + 80kW PV</b>											
CZ01	PG&E	-54,712	16917	74.6	(\$1,123,442)	(\$240,170)	\$106,722	4.7	>1	\$883,272	\$1,230,164
CZ02	PG&E	8,853	12677	65.0	(\$1,124,415)	\$128,649	\$223,510	>1	>1	\$1,253,063	\$1,347,925
CZ03	PG&E	15,612	12322	65.3	(\$1,126,687)	\$44,532	\$215,260	>1	>1	\$1,171,219	\$1,341,947
CZ04	PG&E	15,490	11927	62.0	(\$1,126,522)	\$145,778	\$225,402	>1	>1	\$1,272,300	\$1,351,924
CZ04-2	CPAU	15,490	11927	62.0	(\$1,126,522)	\$289,094	\$225,402	>1	>1	\$1,415,616	\$1,351,924
CZ05	PG&E	25,436	11960	64.8	(\$1,126,575)	\$56,019	\$229,149	>1	>1	\$1,182,594	\$1,355,724
CZ06	SCE	48,875	8912	54.4	(\$1,126,716)	\$163,343	\$253,445	>1	>1	\$1,290,060	\$1,380,161
CZ06-2	LA	62,439	8188	54.1	(\$1,125,064)	\$115,822	\$266,502	>1	>1	\$1,240,886	\$1,391,565
CZ07	SDG&E	56,727	8353	53.5	(\$1,123,034)	\$147,987	\$275,773	>1	>1	\$1,271,022	\$1,398,808
CZ08	SCE	56,727	8353	53.5	(\$1,123,034)	\$163,971	\$275,773	>1	>1	\$1,287,005	\$1,398,808
CZ08-2	LA	55,185	8402	53.7	(\$1,124,832)	\$155,101	\$266,880	>1	>1	\$1,279,933	\$1,391,712
CZ09	SCE	55,185	8402	53.7	(\$1,124,832)	\$169,010	\$266,880	>1	>1	\$1,293,843	\$1,391,712
CZ09-2	LA	50,731	8418	52.0	(\$1,121,834)	\$113,936	\$249,207	>1	>1	\$1,235,770	\$1,371,041
CZ10	SDG&E	50,731	8418	52.0	(\$1,121,834)	\$138,265	\$249,207	>1	>1	\$1,260,099	\$1,371,041
CZ10-2	SCE	25,882	10252	55.6	(\$1,122,643)	\$162,626	\$229,944	>1	>1	\$1,285,269	\$1,352,587
CZ11	PG&E	27,731	10403	57.1	(\$1,124,083)	\$12,954	\$236,794	>1	>1	\$1,137,037	\$1,360,876
CZ12	PG&E	28,136	10403	57.2	(\$1,124,083)	\$206,756	\$238,005	>1	>1	\$1,330,839	\$1,362,087
CZ12-2	SMUD	26,706	10029	55.0	(\$1,122,455)	\$165,991	\$219,574	>1	>1	\$1,288,446	\$1,342,030
CZ13	PG&E	41,989	10056	57.8	(\$1,122,814)	\$22,333	\$273,768	>1	>1	\$1,145,147	\$1,396,582
CZ14	SDG&E	41,989	10056	57.8	(\$1,122,814)	\$120,943	\$273,768	>1	>1	\$1,243,757	\$1,396,582
CZ14-2	SCE	83,393	5579	44.0	(\$1,120,934)	\$210,511	\$276,228	>1	>1	\$1,331,445	\$1,397,162
CZ15	SCE	-76,971	17599	69.2	(\$1,127,210)	(\$199,308)	\$53,550	5.7	>1	\$927,902	\$1,180,760
CZ16	PG&E	-76,971	17599	69.2	(\$1,127,210)	\$172,787	\$53,550	>1	>1	\$1,299,997	\$1,180,760
CZ16-2	LA	-54,712	16917	74.6	(\$1,123,442)	(\$240,170)	\$106,722	4.7	>1	\$883,272	\$1,230,164



**Figure 77. Cost Effectiveness for Small Hotel – All-Electric + 80kW PV + 50 kWh Battery**

CZ	IOU territory	Elec Savings (kWh)	Gas Savings (therms)	GHG savings (tons)	Incremental Package Cost	Lifecycle Energy Cost Savings	-\$TDV Savings	B/C Ratio (On-bill)	B/C Ratio (TDV)	NPV (On-bill)	NPV (TDV)
<b>All-Electric + 80kW PV + 50kWh Battery</b>											
CZ01	PG&E	-55,323	16917	75.7	(\$1,095,542)	(\$238,351)	\$118,605	4.6	>1	\$857,191	\$1,214,147
CZ02	PG&E	7,849	12677	67.4	(\$1,096,515)	\$129,794	\$239,632	>1	>1	\$1,226,309	\$1,336,146
CZ03	PG&E	14,594	12322	67.7	(\$1,098,787)	\$43,166	\$235,280	>1	>1	\$1,141,953	\$1,334,067
CZ04	PG&E	14,459	11927	64.4	(\$1,098,622)	\$148,698	\$249,244	>1	>1	\$1,247,320	\$1,347,866
CZ04-2	CPAU	14,459	11927	64.4	(\$1,098,622)	\$286,573	\$249,244	>1	>1	\$1,385,195	\$1,347,866
CZ05	PG&E	24,292	11960	67.6	(\$1,098,675)	\$53,719	\$244,514	>1	>1	\$1,152,394	\$1,343,189
CZ06	SCE	47,762	8912	57.2	(\$1,098,816)	\$165,763	\$267,221	>1	>1	\$1,264,579	\$1,366,037
CZ06-2	LA	61,252	8188	57.1	(\$1,097,164)	\$138,060	\$283,797	>1	>1	\$1,235,223	\$1,380,960
CZ07	SDG&E	55,588	8353	56.2	(\$1,095,134)	\$138,718	\$286,483	>1	>1	\$1,233,852	\$1,381,618
CZ08	SCE	55,588	8353	56.2	(\$1,095,134)	\$165,932	\$286,483	>1	>1	\$1,261,066	\$1,381,618
CZ08-2	LA	54,162	8402	56.1	(\$1,096,932)	\$149,615	\$269,453	>1	>1	\$1,246,548	\$1,366,386
CZ09	SCE	54,162	8402	56.1	(\$1,096,932)	\$171,168	\$269,453	>1	>1	\$1,268,101	\$1,366,386
CZ09-2	LA	49,832	8418	54.1	(\$1,093,934)	\$120,627	\$250,720	>1	>1	\$1,214,561	\$1,344,654
CZ10	SDG&E	49,832	8418	54.1	(\$1,093,934)	\$136,144	\$250,720	>1	>1	\$1,230,078	\$1,344,654
CZ10-2	SCE	25,148	10252	57.3	(\$1,094,743)	\$160,744	\$233,842	>1	>1	\$1,255,487	\$1,328,585
CZ11	PG&E	26,813	10403	59.2	(\$1,096,183)	\$10,314	\$247,504	>1	>1	\$1,106,497	\$1,343,686
CZ12	PG&E	27,217	10403	59.3	(\$1,096,183)	\$206,749	\$248,790	>1	>1	\$1,302,931	\$1,344,973
CZ12-2	SMUD	26,027	10029	56.5	(\$1,094,555)	\$164,506	\$229,300	>1	>1	\$1,259,061	\$1,323,856
CZ13	PG&E	41,123	10056	59.7	(\$1,094,914)	\$25,707	\$276,947	>1	>1	\$1,120,621	\$1,371,860
CZ14	SDG&E	41,123	10056	59.7	(\$1,094,914)	\$119,382	\$276,947	>1	>1	\$1,214,296	\$1,371,860
CZ14-2	SCE	82,697	5579	45.5	(\$1,093,034)	\$209,837	\$277,287	>1	>1	\$1,302,871	\$1,370,321
CZ15	SCE	-77,815	17599	71.1	(\$1,099,310)	(\$193,758)	\$65,850	5.7	>1	\$905,552	\$1,165,160
CZ16	PG&E	-77,815	17599	71.1	(\$1,099,310)	\$175,872	\$65,850	>1	>1	\$1,275,182	\$1,165,160
CZ16-2	LA	-55,323	16917	75.7	(\$1,095,542)	(\$238,351)	\$118,605	4.6	>1	\$857,191	\$1,214,147



### 6.8 List of Relevant Efficiency Measures Explored

The Reach Code Team started with a potential list of energy efficiency measures proposed for 2022 Title 24 codes and standards enhancement measures, as well as measures from the 2018 International Green Construction Code, which is based on ASHRAE Standard 189.1-2017. The team also developed new measures based on their experience. This original list was over 100 measures long. The measures were filtered based on applicability to the prototypes in this study, ability to model in simulation software, previously demonstrated energy savings potential, and market readiness. The list of 28 measures below represent the list of efficiency measures that meet these criteria and were investigated to some degree. The column to the far right indicates whether the measure was ultimately included in analysis or not.

**Figure 78. List of Relevant Efficiency Measures Explored**

Building Component	Measure Name	Measure Description	Notes	Include?
Water Heating	Drain water Heat Recovery	Add drain water heat recovery in hotel prototype	Requires calculations outside of modeling software.	Y
Envelope	High performance fenestration	Improved fenestration SHGC (reduce to 0.22).		Y
Envelope	High SHGC for cold climates	Raise prescriptive fenestration SHGC (to 0.45) in cold climates where additional heat is beneficial.		Y
Envelope	Allowable fenestration by orientation	Limit amount of fenestration as a function of orientation		Y
Envelope	High Thermal Mass Buildings	Increase building thermal mass. Thermal mass slows the change in internal temperature of buildings with respect to the outdoor temperature, allowing the peak cooling load during summer to be pushed to the evening, resulting in lower overall cooling loads.	Initial energy modeling results showed marginal cooling savings, negative heating savings.	N
Envelope	Opaque Insulation	Increases the insulation requirement for opaque envelopes (i.e., roof and above-grade wall).	Initial energy modeling results showed marginal energy savings at significant costs which would not meet c/e criteria.	N
Envelope	Triple pane windows	U-factor of 0.20 for all windows	Initial energy modeling results showed only marginal energy savings and, in some cases, increased energy use.	N



Building Component	Measure Name	Measure Description	Notes	Include?
Envelope	Duct Leakage Testing	Expand duct leakage testing requirements based on ASHRAE Standard 215-2018: Method of Test to Determine Leakage of Operating HVAC Air Distribution Systems (ANSI Approved).	More research needs to be done on current duct leakage and how it can be addressed.	N
Envelope	Fenestration area	Reduce maximum allowable fenestration area to 30%.	Instead of this measure, analyzed measure which looked at limiting fenestration based on wall orientation.	N
Envelope	Skinny triple pane windows	U-factor of 0.20 for all windows, with no changes to existing framing or building structure.	Market not ready. No commercially-available products for commercial buildings.	N
Envelope	Permanent projections	Detailed prescriptive requirements for shading based on ASHRAE 189. PF >0.50 for first story and >0.25 for other floors. Many exceptions. Corresponding SHGC multipliers to be used.	Title 24 already allows owner to trade off SHGC with permanent projections. Also, adding requirements for permanent projections would raise concerns.	N
Envelope	Reduced infiltration	Reduce infiltration rates by improving building sealing.	Infiltration rates are a fixed ACM input and cannot be changed. A workaround attempt would not be precise, and the practicality of implementation by developers is low given the modeling capabilities and the fact that in-field verification is challenging. Benefits would predominantly be for air quality rather than energy.	N



Building Component	Measure Name	Measure Description	Notes	Include?
HVAC	Heat recovery ventilation	For the hotel, recover and transfer heat from exhausted air to ventilation air.	<p>For small hotels, the ventilation requirement could be met by various approaches, and the most common ones are:</p> <ul style="list-style-type: none"> <li>a. Exhaust only system, and ventilation is met by infiltration or window operation.</li> <li>b. Through a Z-duct that connects the zone AC unit's intake to an outside air intake louver.</li> <li>c. Centralized ventilation system (DOAS)</li> </ul> <p>The prototype developed for the small hotel is using Type 2 above. The major consideration is that currently, HRV + PTACs cannot be modeled at each guest room, only at the rooftop system. Option 1 would require the same type of HRV implementation as Option 2. Option 3 may be pursuable, but would require a significant redesign of the system, with questionable impacts. Previous studies have found heat recovery as cost effective in California only in buildings with high loads or high air exchange rates, given the relatively mild climate.</p>	N
HVAC	Require Economizers in Smaller Capacity Systems	Lower the capacity trigger for air economizers. Previous studies have shown cost effectiveness for systems as low as 3 tons.		Y
HVAC	Reduce VAV minimum flow limit	Current T24 and 90.1 requirements limit VAV minimum flow rates to no more than 20% of maximum flow. Proposal based on ASHRAE Guideline 36 which includes sequences that remove technical barriers that previously existed. Also, most new DDC controllers are now capable of lower limits. The new limit may be as low as the required ventilation rate. A non-energy benefit of this measure is a reduction in over-cooling, thus improving comfort.		Y



Building Component	Measure Name	Measure Description	Notes	Include?
HVAC	Building Automation System (BAS) improvements	With adoption of ASHRAE Guideline 36 (GDL-36), there is now a national consensus standard for the description of high-performance sequences of operation. This measure will update BAS control requirements to improve usability and enforcement and to increase energy efficiency. BAS control requirement language will be improved either by adoption of similar language to GDL-36, or reference to GDL-36. Specific T24 BAS control topics that will be addressed include at a minimum: DCV, demand-based reset of SAT, demand-based reset of SP, dual-maximum zone sequences, and zone groups for scheduling.	In order to realize any savings in the difference, we would need a very detailed energy model with space-by-space load/occupant diversity, etc. We would also need more modeling capability than is currently available in CBECC-Com.	N
HVAC	Fault Detection Devices (FDD)	Expand FDD requirements to a wider range of AHU faults beyond the economizer. Fault requirements will be based on NIST field research, which has consequently been integrated into ASHRAE Guideline 36 Best in Class Sequences of Operations. Costs are solely to develop the sequences, which is likely minimal, and much of the hardware required for economizer FDD is also used to detect other faults.	Market not ready.	N
HVAC	Small circulator pumps ECM, trim to flow rate	Circulator pumps for industry and commercial.	Hot water pump energy use is small already (<1% building electricity usage) so not much savings potential. More savings for CHW pumps. Modeling limitations as well.	N
HVAC	High Performance Ducts to Reduce Static Pressure	Revise requirements for duct sizing to reduce static pressure.	Preliminary energy modeling results showed only marginal energy savings compared to measure cost.	N
HVAC	Parallel fan-powered boxes	Use of parallel fan-powered boxes	Unable to model PFPB with variable speed fans in modeling software.	N
Lighting	Daylight Dimming Plus OFF	Automatic daylight dimming controls requirements include the OFF step.		Y
Lighting	Occupant Sensing in Open Plan Offices	Take the PAF without allowing for increased design wattage		Y
Lighting	Institutional tuning	Take the PAF without allowing for increased design wattage		Y



Building Component	Measure Name	Measure Description	Notes	Include?
Lighting	Reduced Interior Lighting Power Density	Reduced interior LPD values.		Y
Lighting	Shift from general to task illumination	Low levels of general illumination with task and accent lighting added to locations where higher light levels are required. The shift from general to task illumination measure is based on the assumption that proper lighting of a desk surface with high efficacy lighting can allow for the significant reduction of ambient general lighting.	This is a tough measure to require as the LPDs decrease.	N
Lighting	Future-proof lighting controls	Fill any holes in the current code that could lead to the situations where TLEDS or LED fixtures that are not dimmable or upgradable in the future, or any other issues with code that make it hard to transition to ALCS/IoT lighting in the future	Major lighting controls already covered in other measures being considered	N
Lighting	Integrated control of lighting and HVAC systems	Formalize the definition of "lighting and HVAC control integration" by defining the level of data sharing required between systems and the mechanism needed to share such data. The highest savings potential would likely be generated from VAV HVAC systems by closing the damper in unoccupied zones based on the occupancy sensor information from the lighting systems.	Not market ready enough.	N
Other	NR Plug Load Controls	Energy savings opportunities for plug loads, which may include: energy efficient equipment, equipment power management, occupancy sensor control, and occupant awareness programs. The proposal could be extending controlled receptacles requirements in Section 130.5(d) to more occupancy types. It would also consider circuit-level controls.	Office equipment now all have their own standby power modes that use very little power, making plug load controls very difficult to be cost-effective.	N





## 6.9 Additional Rates Analysis - Healdsburg

After the final version of the report was released, the Reach Code Team provided additional cost effectiveness analysis in Climate Zone 2 using City of Healdsburg electric utility rates and PG&E gas rates. All aspects of the methodology remain the same, and the results for each package and prototype are aggregated below in Figure 79 through Figure 81. Results generally indicate:

- ◆ Mixed fuel prototypes achieve positive compliance margins for EE packages and are cost effective.
- ◆ All-electric prototypes achieve slightly lower compliance margins than mixed fuel for EE packages and are cost effective.
- ◆ All PV and PV+Battery packages are cost effective both using an on-bill and TDV approach.



**Figure 79. Healdsburg Utility Rates Analysis - Medium Office, All Packages Cost Effectiveness Summary**

Prototype	Package	Elec Savings (kWh)	Gas Savings (therms)	GHG savings (tons)	Compliance Margin (%)	Incremental Package Cost	Lifecycle Energy Cost Savings	\$-TDV Savings	B/C Ratio (On-bill)	B/C Ratio (TDV)	NPV (On-bill)	NPV (TDV)
Medium Office	Mixed Fuel + EE	40,985	-505	8.1	17%	\$66,649	\$89,645	\$99,181	1.3	1.5	\$22,996	\$32,532
	Mixed Fuel + EE + PVB	255,787	-505	50.6	17%	\$359,648	\$510,922	\$573,033	1.4	1.6	\$151,274	\$213,385
	Mixed Fuel + HE	3,795	550	4.3	4%	\$68,937	\$24,204	\$24,676	0.4	0.4	-\$44,733	-\$44,261
	All-Electric	-49,684	3,868	5.0	-7%	-\$73,695	-\$7,042	-\$41,429	10.5	1.8	\$66,653	\$32,266
	All-Electric + EE	-11,811	3,868	15.2	10%	-\$7,046	\$83,285	\$58,563	>1	>1	\$90,331	\$65,609
	All-Electric + EE + PVB	203,026	3,868	57.8	10%	\$285,953	\$511,954	\$532,273	1.8	1.9	\$226,001	\$246,320
	All-Electric + HE	-45,916	3,868	6.1	-5%	-\$22,722	\$6,983	-\$26,394	>1	0.9	\$29,705	-\$3,672
	Mixed Fuel + 3kW	4,785	0	0.9	n/a	\$5,566	\$10,430	\$10,500	1.9	1.9	\$4,864	\$4,934
	Mixed Fuel + 3kW + 5kWh	4,785	0	0.9	n/a	\$8,356	\$10,430	\$10,500	1.2	1.3	\$2,074	\$2,144
	Mixed Fuel + 135kW	215,311	0	41.5	n/a	\$250,470	\$424,452	\$471,705	1.7	1.9	\$173,982	\$221,235
	Mixed Fuel + 135kW + 50kWh	214,861	0	42.6	n/a	\$278,370	\$423,721	\$472,898	1.5	1.7	\$145,351	\$194,528
	All-Electric + 3kW	-44,899	3,868	6.0	n/a	-\$68,129	\$3,299	-\$30,928	>1	2.2	\$71,429	\$37,201
	All-Electric + 3kW + 5kWh	-44,899	3,868	6.0	n/a	-\$65,339	\$3,299	-\$30,928	>1	2.1	\$68,639	\$34,411
	All-Electric + 135kW	165,627	3,868	46.6	n/a	\$176,775	\$424,146	\$430,276	2.4	2.4	\$247,371	\$253,501
	All-Electric + 135kW + 50kWh	165,200	3,868	47.7	n/a	\$204,675	\$423,466	\$431,469	2.1	2.1	\$218,792	\$226,795
	All-Electric + 80kW + 50kWh	40,985	-505	8.1	17%	\$66,649	\$89,645	\$99,181	1.3	1.5	\$22,996	\$32,532



**Figure 80. Healdsburg Utility Rates Analysis – Medium Retail, All Packages Cost Effectiveness Summary**

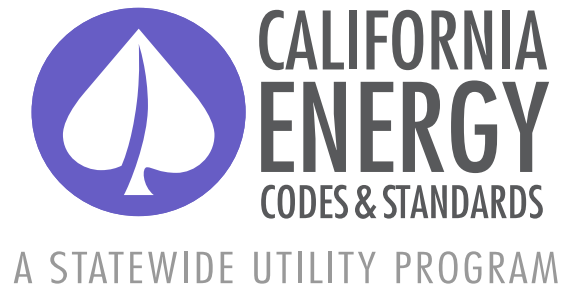
Prototype	Package	Elec Savings (kWh)	Gas Savings (therms)	GHG savings (tons)	Compliance Margin (%)	Incremental Package Cost	Lifecycle Energy Cost Savings	\$-TDV Savings	B/C Ratio (On-bill)	B/C Ratio (TDV)	NPV (On-bill)	NPV (TDV)
Medium Retail	Mixed Fuel + EE	18,885	613	8.7	13%	\$5,569	\$49,546	\$59,135	8.9	10.6	\$43,977	\$53,566
	Mixed Fuel + EE + PVB	189,400	613	43.8	13%	\$249,475	\$376,219	\$465,474	1.5	1.9	\$126,744	\$215,999
	Mixed Fuel + HE	2,288	229	2.0	3%	\$9,726	\$13,143	\$13,998	1.4	1.4	\$3,417	\$4,273
	All-Electric	-21,786	2,448	7.5	-1%	-\$27,464	\$9,228	-\$4,483	>1	6.1	\$36,692	\$22,981
	All-Electric + EE	2,843	2,448	14.6	13%	-\$21,895	\$61,918	\$56,893	>1	>1	\$83,813	\$78,788
	All-Electric + EE + PVB	173,387	2,448	49.9	13%	\$222,012	\$391,257	\$463,431	1.8	2.1	\$169,245	\$241,419
	All-Electric + HE	-16,989	2,448	8.9	3%	-\$4,211	\$23,567	\$11,251	>1	>1	\$27,779	\$15,463
	Mixed Fuel + 3kW	4,685	0	0.9	n/a	\$5,566	\$10,256	\$10,262	1.8	1.8	\$4,690	\$4,696
	Mixed Fuel + 3kW + 5kWh	4,685	0	0.9	n/a	\$8,356	\$10,256	\$10,262	1.2	1.2	\$1,900	\$1,906
	Mixed Fuel + 110kW	171,790	0	33.3	n/a	\$204,087	\$316,293	\$376,300	1.5	1.8	\$112,206	\$172,213
	Mixed Fuel + 110kW + 50kWh	170,542	0	35.1	n/a	\$231,987	\$320,349	\$398,363	1.4	1.7	\$88,363	\$166,376
	All-Electric + 3kW	-17,101	2,448	8.4	n/a	-\$21,898	\$19,523	\$5,779	>1	>1	\$41,421	\$27,677
	All-Electric + 3kW + 5kWh	-17,101	2,448	8.4	n/a	-\$19,108	\$19,523	\$5,779	>1	>1	\$38,631	\$24,887
	All-Electric + 110kW	150,004	2,448	40.8	n/a	\$176,623	\$332,213	\$371,817	1.9	2.1	\$155,591	\$195,194
	All-Electric + 110kW + 50kWh	148,793	2,448	42.9	n/a	\$204,523	\$335,043	\$394,099	1.6	1.9	\$130,520	\$189,577



**Figure 81. Healdsburg Utility Rates Analysis - Small Hotel, All Packages Cost Effectiveness Summary**

Prototype	Package	Elec Savings (kWh)	Gas Savings (therms)	GHG savings (tons)	Compliance Margin (%)	Incremental Package Cost	Lifecycle Energy Cost Savings	-\$TDV Savings	B/C Ratio (On-bill)	B/C Ratio (TDV)	NPV (On-bill)	NPV (TDV)	
Small Hotel	Mixed Fuel + EE	3,802	976	3.9	7%	\$20,971	\$22,829	\$29,353	1.1	1.4	\$1,857	\$8,381	
	Mixed Fuel + EE + PVB	130,144	976	31.1	7%	\$205,967	\$254,577	\$336,575	1.2	1.6	\$48,610	\$130,608	
	Mixed Fuel + HE	981	402	2.7	3%	\$23,092	\$12,291	\$11,808	0.5	0.5	-\$10,801	-\$11,284	
	All-Electric	-	118,739	12,677	40.0	-12%	-\$1,297,757	-\$24,318	-\$51,620	53.4	25.1	\$1,273,439	\$1,246,137
	All-Electric + EE	-88,410	118,739	12,677	45.9	5%	-\$1,265,064	\$45,918	\$20,860	>1	>1	\$1,310,982	\$1,285,924
	All-Electric + EE + PVB	38,115	118,739	12,677	73.5	5%	-\$1,080,068	\$296,233	\$317,296	>1	>1	\$1,376,301	\$1,397,365
	All-Electric + HE	-	118,284	12,677	41.2	-11%	-\$1,283,243	-\$83,994	-\$44,505	15.3	28.8	\$1,199,249	\$1,238,738
	Mixed Fuel + 3kW	4,785	0	0.9	n/a	\$5,566	\$8,927	\$10,332	1.6	1.9	\$3,361	\$4,766	
	Mixed Fuel + 3kW + 5kWh	4,785	0	0.9	n/a	\$8,356	\$8,927	\$10,332	1.1	1.2	\$571	\$1,976	
	Mixed Fuel + 80kW	127,592	0	25.0	n/a	\$148,427	\$229,794	\$275,130	1.5	1.9	\$81,367	\$126,703	
	Mixed Fuel + 80kW + 50kWh	126,332	0	28.1	n/a	\$176,327	\$236,570	\$296,058	1.3	1.7	\$60,243	\$119,731	
	All-Electric + 3kW	-	113,954	12,677	40.9	n/a	-\$1,292,191	-\$14,447	-\$41,288	89.4	31.3	\$1,277,744	\$1,250,902
	All-Electric + 3kW + 5kWh	-	113,954	12,677	40.9	n/a	-\$1,289,401	-\$14,447	-\$41,288	89.3	31.2	\$1,274,954	\$1,248,112
	All-Electric + 80kW	8,853	113,954	12,677	65.0	n/a	-\$1,149,330	\$222,070	\$223,510	>1	>1	\$1,371,400	\$1,372,840
	All-Electric + 80kW + 50kWh	7,849	113,954	12,677	67.4	n/a	-\$1,121,430	\$223,812	\$239,632	>1	>1	\$1,345,241	\$1,361,062





Title 24, Parts 6 and 11  
Local Energy Efficiency Ordinances

## **2019 Mid-Rise New Construction Reach Code Cost-Effectiveness Study**

**Prepared for:**  
Kelly Cunningham  
Codes and Standards Program  
Pacific Gas and Electric Company

**Prepared by:**  
Frontier Energy, Inc.  
Misti Bruceri & Associates, LLC  
EnergySoft

Last Modified: June 22, 2020

**LEGAL NOTICE**

This report was prepared by Pacific Gas and Electric Company and funded by the California utility customers under the auspices of the California Public Utilities Commission.

Copyright 2019, Pacific Gas and Electric Company. All rights reserved, except that this document may be used, copied, and distributed without modification.

Neither PG&E nor any of its employees makes any warranty, express or implied; or assumes any legal liability or responsibility for the accuracy, completeness or usefulness of any data, information, method, product, policy or process disclosed in this document; or represents that its use will not infringe any privately-owned rights including, but not limited to, patents, trademarks or copyrights.

## Table of Contents

Acronyms.....	iii
1 Introduction.....	1
2 Methodology and Assumptions.....	1
2.1 Building Prototypes .....	1
2.2 Measure Analysis.....	3
2.2.1 Federal Preemption .....	3
2.2.2 Energy Efficiency Measures.....	3
2.2.3 All Electric Measures .....	4
2.2.4 Renewable Energy .....	5
2.3 Package Development .....	6
2.4 Incremental Costs.....	6
2.4.1 Energy Efficiency Measure Costs.....	6
2.4.2 All Electric Measure Costs .....	8
2.4.3 Natural Gas Infrastructure Costs .....	9
2.5 Cost-effectiveness .....	10
2.5.1 On-Bill Customer Lifecycle Cost.....	11
2.5.2 TDV Lifecycle Cost.....	12
2.6 Greenhouse Gas Emissions.....	12
3 Results .....	13
3.1 Mid-Rise Multifamily Results.....	13
Efficiency Only: .....	13
Efficiency + PV: .....	14
4 Conclusions & Summary.....	20
5 References.....	22
Appendix A – California Climate Zone Map.....	24
Appendix B – Utility Tariff Details.....	25
Appendix C – PG&E Gas Infrastructure Cost Memo.....	47
Appendix D – Detailed Results Mixed-Fuel .....	50
Appendix E – Detailed Results All-Electric.....	53

## List of Tables

Table 1: Prototype Characteristics .....	2
Table 2: Incremental Cost Assumptions .....	7
Table 3: Costs for Gas versus Electric Water Heating Equipment over 30-Year Period of Analysis.....	8
Table 4: Solar Thermal Detailed Costs over 30-Year Period of Analysis .....	9
Table 5: Natural Gas Infrastructure Cost Savings for All-Electric Building .....	9
Table 6: IOU Utility Tariffs Applied Based on Climate Zone .....	12
Table 7: Mixed-Fuel Package Results: Efficiency Only (SAVINGS/COST PER APARTMENT) .....	15
Table 8: Mixed-Fuel Package Results: PV + Efficiency 0.3 kW <sub>DC</sub> per Apartment (SAVINGS/COST PER APARTMENT) .....	16
Table 9: All-Electric Package Results: Efficiency Only (SAVINGS/COSTS PER APARTMENT) .....	17
Table 10: All-Electric Package Results: PV + Efficiency 0.1 kW <sub>DC</sub> per Apartment (SAVINGS/COSTS PER APARTMENT) .....	18
Table 11: Mixed-Fuel Measure Package Summary .....	19
Table 12: All-Electric Measure Package Summary .....	19
Table 13: Mid-Rise Multifamily Summary of Compliance Margin and Cost-Effectiveness .....	21
Table 14: PG&E Baseline Territory by Climate Zone .....	26
Table 15: PG&E Monthly Gas Rate (\$/Therm).....	26
Table 16: SCE Baseline Territory by Climate Zone.....	32
Table 17: SoCalGas Baseline Territory by Climate Zone.....	35
Table 18: SoCalGas Monthly Gas Rate (\$/Therm) .....	35
Table 19: SDG&E Baseline Territory by Climate Zone .....	38
Table 20: SDG&E Monthly Gas Rate (\$/Therm).....	41
Table 22: Real Utility Rate Escalation Rate Assumptions .....	46
Table 23: Mixed-Fuel Efficiency Only Package Results (SAVINGS/COST PER APARTMENT) <sup>1</sup> .....	50
Table 24: Mixed-Fuel Efficiency + PV Package Results (SAVINGS/COST PER APARTMENT) <sup>1</sup> .....	51
Table 25: Mixed-Fuel Efficiency + PV Package Results , cont. (SAVINGS/COST PER APARTMENT) <sup>1</sup> .....	52

## List of Figures

Figure 1: 5-story mid-rise multifamily prototype depiction.....	2
Figure 2: Prescriptive central heat pump water heater system schematic.....	5
Figure 3: Map of California climate zones. (Source, California Energy Commission) .....	24



## Acronyms

2020 PV\$	Present value costs in 2020
ACM	Alternative Calculation Method
B/C	Lifecycle Benefit-to-Cost Ratio
BSC	Building Standards Commission
CBECC-Com	Computer program developed by the California Energy Commission for use in demonstrating compliance with the California Residential Building Energy Efficiency Standards
CFI	California Flexible Installation
CFM	Cubic Feet per Minute
CPC	California Plumbing Code
CZ	California Climate Zone
DHW	Domestic Hot Water
DOE	Department of Energy
DWHR	Drain Water Heat Recovery
EDR	Energy Design Rating
EER	Energy Efficiency Ratio
EF	Energy Factor
EPS	Expanded Polystyrene
HERS Rater	Home Energy Rating System Rater
HPWH	Heat Pump Water Heater
HVAC	Heating, Ventilation, and Air Conditioning
IOU	Investor Owned Utility
kBtu	kilo-British thermal unit
kWh	Kilowatt Hour
kW <sub>DC</sub>	Kilowatt Direct Current. Nominal rated power of a photovoltaic system
LBNL	Lawrence Berkeley National Laboratory
LCC	Lifecycle Cost
MF	Multifamily
NAECA	National Appliance Energy Conservation Act
NEM	Net Energy Metering
NPV	Net Present Value
PG&E	Pacific Gas and Electric Company
PV	Photovoltaic
SCE	Southern California Edison

SDG&E	San Diego Gas and Electric
SF	Solar Fraction
SHGC	Solar Heat Gain Coefficient
SMUD	Sacramento Municipal Utility District
CASE	Codes and Standards Enhancement
TDV	Time Dependent Valuation
Therm	Unit for quantity of heat that equals 100,000 British thermal units
Title 24	Title 24, Part 6
TOU	Time-Of-Use
UEF	Uniform Energy Factor
W	Watts

# 1 Introduction

The California Building Energy Efficiency Standards Title 24, Part 6 (Title 24) (California Energy Commission, 2018b) is maintained and updated every three years by two state agencies, the California Energy Commission (Energy Commission) and the Building Standards Commission (BSC). In addition to enforcing the code, local jurisdictions have the authority to adopt local energy efficiency ordinances, or reach codes, that exceed the minimum standards defined by Title 24 (as established by Public Resources Code Section 25402.1(h)2 and Section 10-106 of the Building Energy Efficiency Standards). Local jurisdictions must demonstrate that the requirements of the proposed ordinance are cost-effective and do not result in buildings consuming more energy than is permitted by Title 24. In addition, the jurisdiction must obtain approval from the Energy Commission and file the ordinance with the BSC for the ordinance to be legally enforceable.

This report documents cost-effective combinations of measures that exceed the minimum state requirements, the 2019 Building Energy Efficiency Standards, effective January 1, 2020, for new mid-rise (four- to seven-story) multifamily residential construction. The analysis includes evaluation of both mixed-fuel and all-electric residential construction, documenting that the performance requirements can be met by either type of building design. Compliance package options and cost-effectiveness analysis in all 16 California climate zones (CZs) are presented (see Appendix A – California Climate Zone Map for a graphical depiction of Climate Zone locations).

## 2 Methodology and Assumptions

This analysis uses two different metrics to assess cost-effectiveness. Both methodologies require estimating and quantifying the incremental costs and energy savings associated with energy efficiency measures. The main difference between the methodologies is the manner in which they value energy and thus the cost savings of reduced or avoided energy use:

- **Utility Bill Impacts (On-Bill):** Customer-based Lifecycle Cost (LCC) approach that values energy based upon estimated site energy usage and customer on-bill savings using electricity and natural gas utility rate schedules over a 30-year duration accounting for discount rate and energy cost inflation.
- **Time Dependent Valuation (TDV):** Energy Commission LCC methodology, which is intended to capture the “societal value or cost” of energy use including long-term projected costs, such as the cost of providing energy during peak periods of demand and other societal costs, such as projected costs for carbon emissions, as well as grid transmission and distribution impacts. This metric values energy use differently depending on the fuel source (gas, electricity, and propane), time of day, and season. Electricity used (or saved) during peak periods has a much higher value than electricity used (or saved) during off-peak periods (Horii et al., 2014). This is the methodology used by the Energy Commission in evaluating cost-effectiveness for efficiency measures in Title 24, Part 6.

### 2.1 Building Prototypes

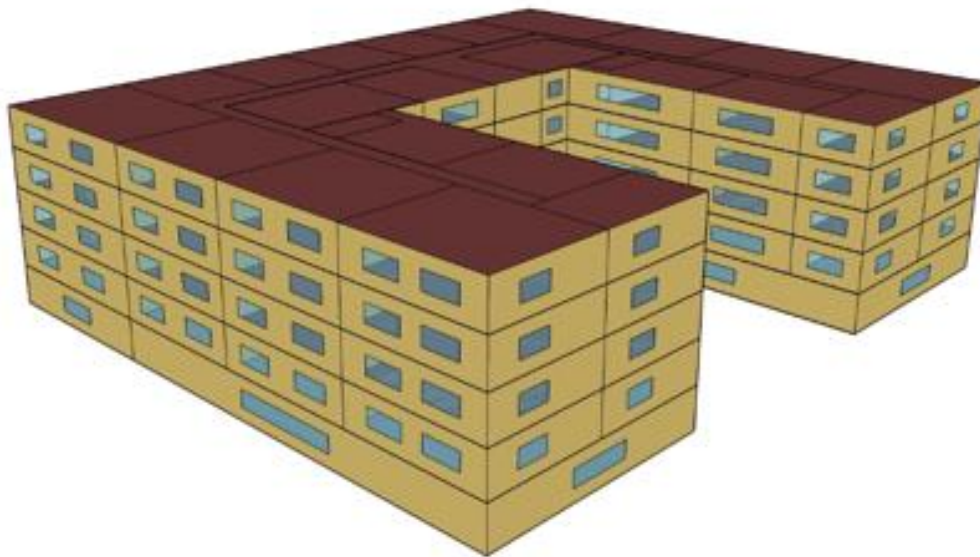
The Energy Commission defines building prototypes which it uses to evaluate the cost-effectiveness of proposed changes to Title 24 requirements. The CEC recently developed new prototype designs for multifamily buildings to more closely reflect typical designs for new multifamily buildings across the state. The new prototypes include two low-rise residential designs, a mid-rise, and a high-rise design. At the time that this report was written, there was one mid-rise multifamily prototype, which is used in this analysis in development of the above-code packages (TRC, 2019). The midrise prototype is a 6-story building with one below-grade parking level, ground floor commercial space, and four stories of residential space. Table 1 describes the basic characteristics of the mid-rise prototype and Figure 1 shows a depiction of the building.



**Table 1: Prototype Characteristics**

Characteristic	Multifamily 5-Story Mid-Rise
Conditioned Floor Area	113,100 ft <sup>2</sup> Total: 33,660 ft <sup>2</sup> Nonresidential & 79,440 ft <sup>2</sup> Residential
Number of Stories	6 Stories Total: 1 Story Parking Garage (below grade) 1 Story of Nonresidential Space 4 Stories of Residential Space
Number of Dwelling Units / Bedrooms	(8) studios, (40) 1-bed units, (32) 2-bed units, & (8) 3-bed units
Foundation	Concrete podium with underground parking
Wall Assembly	Wood frame over a first-floor concrete podium
Roof Assembly	Flat roof
Window-to-Wall Area Ratio	22.5%
HVAC System	Ducted split heat pumps at each apartment
Domestic Hot Water System	Gas central boiler with solar thermal sized to meet the prescriptive requirements by climate zone

Source: TRC 2019



Source: TRC 2019

**Figure 1: 5-story mid-rise multifamily prototype depiction.**

The methodology used in the analyses for the prototypical building type begins with a design that meets the minimum 2019 Title 24 prescriptive requirements (zero compliance margin). Table 140.3-B and 140.3-C in the 2019 Title 24 (California Energy Commission, 2018a) lists the prescriptive measures that determine the baseline design in each climate zone for the nonresidential and high-rise residential spaces, respectively. Other features are consistent with the Standard Design in the Nonresidential ACM Reference Manual (California Energy Commission, 2019a) with one exception. The apartments use split system heat pumps instead of a split furnace

and air conditioner that is prescribed in Table 2 of the Nonresidential ACM Reference Manual. This modeling choice was made to better reflect current market data, which shows heat pumps to be the most common system type and a very low prevalence of gas furnaces for multifamily buildings four stories and greater. This is based on a report completed by TRC (TRC, 2019) and validated by analysis of CA HERS Registry Data by SCE that showed 47% of low-rise multifamily new construction in the 2013 and 2016 code cycles had electric space heating. The analysis also assumed electric cooking in the apartment units to reflect current market data. Laundry was not addressed in this study. The building prototype assumes central laundry facilities and no laundry in the units.

## **2.2 Measure Analysis**

EnergyPro 8.1, which uses the California Building Energy Code Compliance simulation tool, CBECC-Com 2019.1.2, as the simulation engine, was used to evaluate energy impacts using the 2019 Title 24 prescriptive standards as the benchmark, and the 2019 TDV values. CBECC-Com was used for this analysis to evaluate the mid-rise building for code compliance under the 2019 non-residential standards. TDV is the energy metric used by the Energy Commission since the 2005 Title 24 energy code to evaluate compliance with the Title 24 Standards.

Using the 2019 baseline as the starting point, prospective energy efficiency measures were identified and modeled to determine the projected site energy (Therm and kWh) and compliance impacts. Annual utility costs were calculated using hourly data output from CBECC-Com, and electricity and natural gas tariffs for each of the investor owned utilities (IOUs).

This analysis focused on the residential apartments only. A prior study and report demonstrated the cost-effectiveness of above code packages for nonresidential buildings (Statewide Reach Code Team, 2019a). The Statewide Reach Code Team selected measures for evaluation based on the residential and nonresidential 2019 reach code analysis ((Statewide Reach Code Team, 2019a), (Statewide Reach Code Team, 2019b)) as well as experience with and outreach to architects, builders, and engineers along with general knowledge of the relative acceptance of many measures. Efficiency measure packages found to be cost-effective in the nonresidential building reach code analysis were applied to the nonresidential spaces for evaluating performance relative to compliance, but the incremental costs and energy impacts of these measures on the nonresidential spaces were not included in this analysis. Refer to the nonresidential reach code study for more details (Statewide Reach Code Team, 2019a).

### **2.2.1 Federal Preemption**

The Department of Energy (DOE) sets minimum efficiency standards for equipment and appliances that are federally regulated under the National Appliance Energy Conservation Act (NAECA), including heating, cooling, and water heating equipment. Since state and local governments are prohibited from adopting policies that mandate higher minimum efficiencies than the federal standards require, the focus of this study is to identify and evaluate cost-effective packages that do not include high efficiency equipment. While this study is limited by federal preemption, in practice builders may use any package of compliant measures to achieve the performance goals, including high efficiency appliances. Often, these measures are the simplest and most affordable measures to increase energy performance.

### **2.2.2 Energy Efficiency Measures**

Following are descriptions of each of the efficiency measures evaluated for the residential spaces under this analysis. Because not all of the measures described below were found to be cost-effective, and cost-effectiveness varied by climate zone, not all measures are included in all packages and some of the measures listed are not included in any final package.

**Improved Fenestration – Lower U-factor:** Reduce window U-factor to 0.25 Btu/hr-ft<sup>2</sup>-°F. The prescriptive maximum U-factor is 0.36 in all climates. This measure is applied to all windows on floors two through five.



**Improved Fenestration – Lower SHGC:** Reduce window solar heat gain coefficient (SHGC) to 0.22. The prescriptive maximum SHGC is 0.25 for fixed windows in all climates. The Statewide Reach Code Team evaluated increased SHGC in heating dominated climates (Climate Zone 1, 3, 5, and 16) but results were better with a lower SHGC. This measure is applied to all windows on floors two through five.

**Exterior Wall Insulation:** Add one inch of R-4 exterior continuous insulation. To meet the prescriptive wall requirements, it's assumed that exterior wall insulation is used in the basecase, therefore this measure adds additional R-value to existing exterior insulation. This measure is applied to all walls on floors two through five.

**HERS Verification of Hot Water Pipe Insulation:** The California Plumbing Code (CPC) requires pipe insulation on all hot water lines. This measure provides credit for HERS Rater verification of pipe insulation requirements according to the procedures outlined in the 2019 Reference Appendices RA3.6.3. (California Energy Commission, 2018b).

**Low Pressure Drop Ducts:** Upgrade the duct distribution system to reduce external static pressure and meet a maximum fan efficacy of 0.25 watts per cfm operating at full speed. This may involve upsizing ductwork, reducing the total effective length of ducts, and/or selecting low pressure drop components, such as filters. This measure is applied to the ducted split heat pumps serving the apartments.

**Solar Thermal:** Prescriptively, central water heating systems require a solar thermal system with a 20% solar fraction in Climates Zones 1 through 9 and 35% solar fraction in Climate Zones 10 through 16. This measure upgrades the prescriptive solar thermal system to meet a 50% solar fraction in all climates, assuming there is available roof space for the additional collectors.

**Drain Water Heat Recovery:** Add drain water heat recovery with a 50% effectiveness to serve all the apartments. The assumption is for an unequal flow design where the output of the heat exchanger feeds only the cold water inlets to the apartment showers, not the water heater cold water makeup.

Efficiency measures were applied to the nonresidential spaces based on the 2019 Nonresidential Reach Code Cost-Effectiveness Study (Statewide Reach Code Team, 2019a).

### **2.2.3 All Electric Measures**

This analysis assumes that the basecase prototype model uses individual heat pumps for space heating and all electric appliances in the apartments. Therefore, the domestic hot water system is the only equipment serving the apartment spaces to electrify in the all-electric design. The Statewide Reach Code Team evaluated two configurations for electric heat pump water heaters (HPWHs) described below.

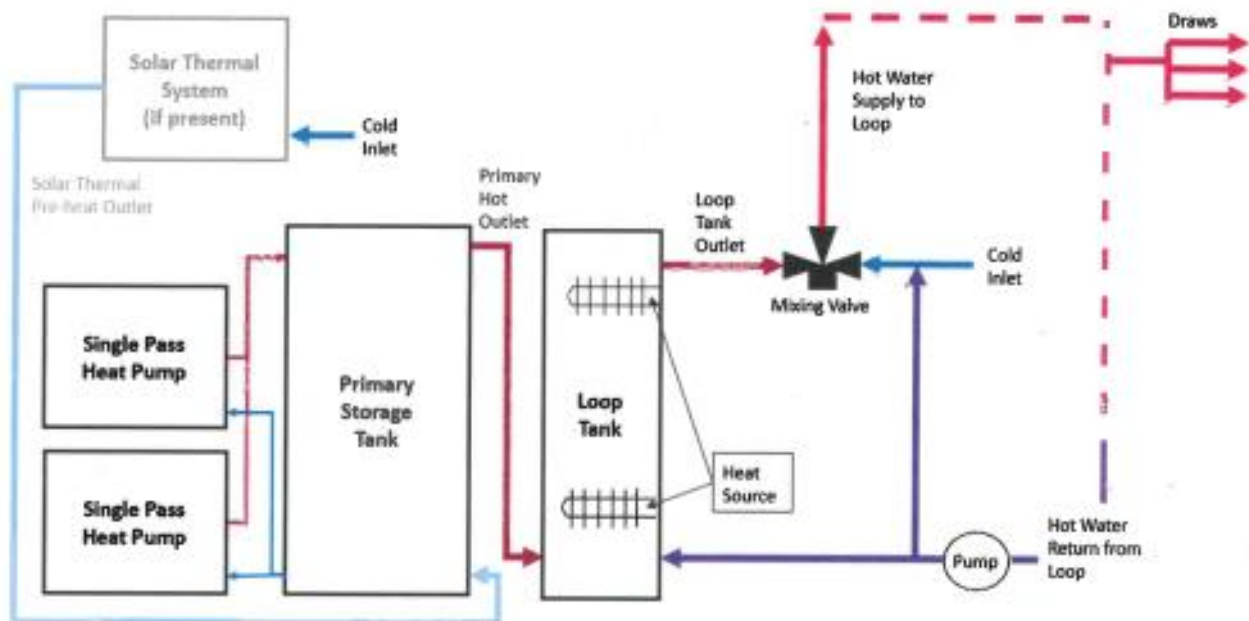
**Clustered Heat Pump Water Heater:** This clustered design uses residential integrated storage HPWHs to serve more than one apartment; 4 to 5 bedrooms on average for a total of 32 HPWHs in the 88-unit building. The water heaters are located in interior closets throughout the building and designed for short plumbing runs without using a hot water recirculation loop. A minimum efficiency 2.0 UEF HPWH was used for this analysis (to avoid federal preemption). This approach has been selectively used in multifamily projects because of its reliance on lower cost small capacity HPWH products. Since it uses residential equipment with each HPWH serving fewer than 8 apartments the CBECC-Com compliance software had the capability to evaluate this design strategy, even before central HPWH recirculation options were incorporated into the software. The clustered strategy is not a prescriptive option but is allowed in the performance path if the water heater serves no more than 8 units and has no recirculation control. The standard design assumes solar thermal, so the proposed design is penalized in compliance for no solar thermal and made up with other efficiency measures.



**Prescriptive Central Heat Pump Water Heater:** Per Section 150.1(c)8C of the 2019 Standards, the Energy Commission made an executive determination outlining requirements of a prescriptive approach for central heat pump water heating systems in December 2019 (California Energy Commission, 2019b). Key aspects of the prescriptive approach are described below:

- The system must be configured with a design similar to what is presented in the schematic in Figure 2 of the executive determination document.
- HPWH must be single-pass split system with the compressor located outdoors and be able to operate down to -20°F. In CBECC-Com 2019.1.2, the current version at the time of writing this report, the software only has the capability of modeling Sanden HPWHs.
- The system must include either a solar thermal water heating system that meets the current prescriptive requirements or 0.1 kW<sub>DC</sub> of photovoltaic system capacity per apartment/dwelling unit.

For this configuration the Statewide Reach Code Team evaluated costs for a central HPWH system using Sanden compressors that met these prescriptive requirements. Based on the system sizing requirements, 15 Sanden units and 1,200 gallons of primary storage capacity are required for the 88-unit building. At the time that cost-effectiveness was initially compared for the two HPWH configurations, the latest CBECC-Com software with the ability to model central HPWH systems was not yet available. To estimate the energy use for the central configuration, the water heating energy use for the clustered configuration was used. It is expected that the energy use of the central system will be higher than the clustered approach primarily as a result of recirculation pump energy and losses.



**Figure 2: Prescriptive central heat pump water heater system schematic.**

All-electric measures were applied to the nonresidential spaces based on the 2019 Nonresidential Reach Code Cost-Effectiveness Study (Statewide Reach Code Team, 2019a).

#### 2.2.4 Renewable Energy

**Solar Photovoltaic (PV):** There is no existing requirement for PV in the 2019 Title 24 nonresidential code for high-rise residential buildings (four or more stories). The PV sizing methodology was developed to offset a portion of annual residential electricity use and avoid oversizing which would violate net energy metering (NEM)

rules. In all cases, PV is evaluated using the PV simulations within CBECC-Com using a Standard module type, 180 degree azimuth, and 22 degree .tilt. The analysis evaluated PV system capacities equal to 0.1, 0.2, 0.3, and 1 kW<sub>DC</sub> per apartment. The PV system offsets approximately XX4%, XX8%, XX13%, and 42%, of the apartment electricity usage, respectively. Assuming 15 Watts per square foot for a typical commercial PV system, 1 kW<sub>DC</sub> per apartment, or 88 kW<sub>DC</sub> total, would take up about 25% of the total roof area.

### 2.3 Package Development

Four packages were evaluated for each climate zone, as described below.

- 1) **Efficiency – Mixed-fuel:** This package applies efficiency measures that don't trigger federal preemption including envelope, water heating distribution, and duct distribution efficiency measures.
- 2) **Efficiency – All Electric:** This package applies efficiency measures that don't trigger federal preemption in addition to converting any natural gas appliances to electric appliances. For the residential spaces, only water heating is converted from natural gas to electric.
- 3) **Efficiency & PV – Mixed-fuel:** Beginning with the Efficiency Package , PV was added to offset a portion of the apartment estimated electricity use.
- 4) **Efficiency & PV – All Electric:** Beginning with the Efficiency Package, PV was added to offset a portion of the apartment estimated electricity use.

### 2.4 Incremental Costs

#### 2.4.1 Energy Efficiency Measure Costs

Table 22 summarizes the incremental cost assumptions for measures evaluated in this study relative to the residential parts of the building. Incremental costs represent the equipment, installation, replacement, and maintenance costs of the proposed measures relative to the base case. Replacement costs are applied to PV inverters and battery systems over the 30-year evaluation period. There is no assumed maintenance on the envelope, HVAC, or DHW measures. Costs were estimated to reflect costs to the building owner. When costs were obtained from a source that did not already include builder overhead and profit, a markup of 10% was added. All costs are provided as present value in 2020 (2020 PV\$). Costs due to variations in furnace, air conditioner, and heat pump capacity by climate zone were not accounted for in the analysis.





**Table 2: Incremental Cost Assumptions**

Measure	Performance Level	Incremental Cost (2020 PV\$)	Source & Notes
<b>Non-Preempted Measures</b>			
Window U-factor	0.25 vs 0.36	\$28,301	\$6.95/ft <sup>2</sup> window area based on analysis conducted for the 2019 and 2022 Title 24 code cycles (Statewide CASE Team, 2018).
Window SHGC	0.22 vs 0.25	\$0	Data from CASE Report along with direct feedback from Statewide CASE Team that higher SHGC does not necessarily have any incremental cost impact (Statewide CASE Team, 2017b).
Exterior Wall Insulation	Add 1-inch	\$14,058	\$0.86/ft <sup>2</sup> based on adding 1" of exterior insulation on a wall with some level of existing exterior insulation. Costs are averaged from two sources ((Statewide CASE Team, 2014), (Statewide CASE Team, 2017a)) and for expanded polystyrene (EPS) and polyisocyanurate products with a 10% mark-up added to account for cost increases over time.
HERS Verified Pipe Insulation	HERS verified pipe insulation vs no verification	\$7,260	\$83 per apartment for a HERS Rater to conduct verification of pipe insulation based on feedback from HERS Raters.
Low Pressure Drop Ducts	0.25 W/cfm vs 0.35 W/cfm	\$12,654	\$144 per apartment. Costs assume 1.5 hours labor per multifamily apartment. Labor rate of \$96 per hour is from 2019 RSMeans for sheet metal workers and includes an average City Cost Index for labor for California cities.
Solar Thermal	50% solar fraction vs prescriptive 20%-35%	\$79,560	Costs based on 2022 multifamily solar thermal measure CASE proposal (Statewide CASE Team, 2020) and include first cost of \$70,727 and \$8,834 present value for replacement/maintenance costs.
Drain Water Heat Recovery	50% effectiveness, flows to shower	\$16,984	Costs from 2019 DWHR CASE Report which assumes 1 heat exchanger per 4 units (Statewide CASE Team, 2017c). Costs do not include additional cost of water meters at each apartment (per SB7), which would add approx. \$175 per dwelling unit.
<b>Renewable Energy (PV)</b>			
PV System	System size varies	\$3.17/W <sub>DC</sub>	First costs are from LBNL's Tracking the Sun 2018 costs (Barbose et al., 2018) and represent costs for the first half of 2018 of \$2.90/W <sub>DC</sub> for nonresidential systems ≤500 kW <sub>DC</sub> . These costs were reduced by 16% for the solar investment tax credit, which is the average credit over years 2020-2022. Inverter replacement cost of \$0.14/W <sub>DC</sub> present value includes replacements at year 11 at \$0.15/W <sub>DC</sub> (nominal) and at year 21 at \$0.12/W <sub>DC</sub> (nominal) per the 2019 PV CASE Report (California Energy Commission, 2017). System maintenance costs of \$0.31/W <sub>DC</sub> present value assumes additional \$0.02/W <sub>DC</sub> (nominal) annually per the 2019 PV CASE Report (California Energy Commission, 2017). 10% overhead and profit added to all costs.



### 2.4.2 All Electric Measure Costs

The Statewide Reach Code Team reached out to stakeholders to collect project cost information for central gas boilers and both clustered and central HPWH designs. Project data sources included Association for Energy Affordability (AEA), Redwood Energy, Mithun, Ecotope, and the All-Electric Multifamily Compliance Pathway 2022 Draft CASE Report (Statewide CASE Team, 2020). Costs are presented in Table 3.

**Table 3: Costs for Gas versus Electric Water Heating Equipment over 30-Year Period of Analysis**

	Central Gas Boiler (CZs 1-9)	Central Gas Boiler (CZs 10-16)	Clustered HPWH	Central HPWH
<b>System Quantity/Description</b>	1 boiler recirc		32 units 80 gal. each no recirc	15 units .1,200-gal total recirc
<b>Total Equipment Cost</b>	\$98,733		\$126,778	\$213,364
<b>Solar Thermal</b>	(20% SF) 110,096	(35% SF) \$131,817	-	-
<b>Solar PV</b>	-	-	-	\$23,580 (8.8 kW <sub>DC</sub> )
<b>Total First Cost</b>	\$202,920	\$224,641	\$126,778	\$236,944
<b>Maintenance/Replacement Cost (NPV)</b>	\$69,283	\$69,283	\$81,374	\$120,683
<b>Total Cost (NPV)</b>	\$272,203	\$293,924	\$208,152	\$357,627
<b>Incremental Cost CZ 1-9 (NPV)</b>			(\$64,051)	\$85,424
<b>Incremental Cost CZ 10-16 (NPV)</b>			(\$85,772)	\$63,703

Typical costs for the water heating systems are based on the following assumptions:

**Central Gas Boiler:** Based on the average of total estimated project costs from contractors for four multi-family projects ranging from 32 to 340 apartments and cost estimates for mid-rise and high-rise buildings from the All-Electric Multifamily Compliance Pathway 2022 Draft CASE Report (Statewide CASE Team, 2020). The cost per dwelling unit ranged from \$547 to \$2,089 and the average cost applied in this analysis was \$1,122 per dwelling unit. Costs include installation of gas piping from the building meter to the water heater. Water heater lifetime is assumed to be 15 years and the net present value replacement cost at year 15 is \$63,373.

**Clustered HPWH:** Based on costs from one project with RHEEM HPWHs used in a clustered design. Costs include water heater interior closet, electrical outlets, and increased breaker size and sub feed. Water heater based on 2.0 UEF 80-gallon appliance with 32 total HPWHs serving the building (1 per 4 to 5 bedrooms). Water heater lifetime is assumed to be 15 years and the net present value replacement cost at year 15 is \$81,374. This design assumes 8 water heater closets per floor, at approximately 15 square feet per closet. While this has an impact on leasable floor area, the design impacts have been found to be minimal when addressed early in design.

**Central HPWH:** Based on average total installed project costs from four multi-family projects with Sanden HPWHs ranging from 4 to 16 Sanden units per project. The cost per Sanden HPWH ranged from \$13,094 to \$15,766 and the average cost applied in this analysis was \$14,224 per HPWH. Based on the prescriptive system sizing requirements, 15 Sanden units are required for the 88-unit building, resulting in a total first cost of \$213,364. Water heater lifetime is assumed to be 15 years. Because Sanden HPWHs are an emerging technology in the United States, it is expected that over time their costs will decrease and for replacement at year 15 the costs are assumed to have decreased by 15%.



**Solar Thermal:** Based on system costs provided in the All-Electric Multifamily Compliance Pathway 2022 Draft CASE Report (Statewide CASE Team, 2020). First costs reflect the material, labor, and markup costs presented in the Draft CASE Report for the mid-rise prototype. Replacement and maintenance costs assume replacement of the solar thermal tank at year 15 at \$6,110 and glycol replacement of \$1,300 each time at years 9, 18, and 27. The cost of the remaining useful life of the glycol at year 30 is deducted from the final cost. The Draft CASE Report included costs for replacing the solar collectors at year 20. Collectors can have longer lifetimes up to 30 years if well maintained, therefore this analysis does not assume any replacement of the collectors over the 30 year analysis period.

**Table 4: Solar Thermal Detailed Costs over 30-Year Period of Analysis**

Solar Fraction	20%	35%
Materials	\$33,975	\$48,975
Labor	\$47,740	\$49,776
Markup	27.5%	27.5%
First Cost	\$104,187	\$125,908
Replacement/Maintenance (PV)	\$5,910	\$5,910
<b>Total PV Cost</b>	<b>\$110,096</b>	<b>\$131,817</b>

### 2.4.3 Natural Gas Infrastructure Costs

This analysis assumes that in an all-electric new construction project, natural gas would not be supplied to the building. Eliminating natural gas to the building would save costs associated with connecting a service line from the street main to the building, piping distribution within the building, and monthly meter connection charges from the utility. Incremental costs for natural gas infrastructure in the mixed-fuel building are presented in Table 5. Cost data for the plan review and service extension was estimated on a per building basis and then **apportioned to the residential and nonresidential portions of the buildings based on annual gas consumption.** For the basecase prototype building 49% to 93% of estimated building annual gas use is attributed to the residential water heating system across all climate zones. A statewide average of 80% was calculated and applied to the costs in Table 5 based on housing starts provided by the California Energy Commission for the 2019 Title 24 code development process. The meter costs were based on the service provided to the residential and nonresidential portion of the building separately. Following the table are descriptions of assumptions for each of the cost components. Costs for gas piping from the meter to the gas boilers are included in the central gas boiler costs above. Gas piping distribution costs were typically included in total project costs and could not be broken out in all cases.

**Table 5: Natural Gas Infrastructure Cost Savings for All-Electric Building**

Item	Total	NonResidential Portion	Residential Portion
Natural Gas Plan Review	\$2,316	\$452	\$1,864
Service Extension <sup>1</sup>	\$4,600	\$898	\$3,702
Meter	\$7,200	\$3,600	\$3,600
<b>Total First Cost</b>	<b>\$14,116</b>	<b>\$4,950</b>	<b>\$9,166</b>

<sup>1</sup>Service extension costs include 50% reduction assuming portion of the costs are passed on to gas customers.

**Natural Gas Plan Review:** Total costs are based on TRC's 2019 reach code analysis for Palo Alto (TRC, 2019) and then split between the residential and nonresidential spaces in the building proportionately according to annual gas consumption with 80% of the annual load is attributed to residential units on a statewide basis.

**Service Extension:** Service extension costs to the building were taken from PG&E memo dated December 5, 2019, to Energy Commission staff, include costs for trenching, and assume non-residential new construction within a developed area (see Appendix C – PG&E Gas Infrastructure Cost Memo, PG&E, 2019). The total cost of



\$9,200 from the memo is reduced by 50% to account for the portion of the costs paid for by all customers due to application of Utility Gas Main Extensions rules<sup>1</sup>. The resultant cost is apportioned between the residential and nonresidential spaces in the building based on annual gas consumption of residential and nonresidential uses, with 80% of the annual load natural gas use attributed to residential units on a statewide basis.

**Meter:** Cost per meter provided by PG&E for commercial meters. Assume one meter for nonresidential boilers serving space heating and service water heating, and another for residential boilers serving domestic hot water.

## 2.5 Cost-effectiveness

Cost-effectiveness was evaluated for all 16 California climate zones and is presented based on both TDV energy, using the Energy Commission’s LCC methodology, and an On-Bill approach using residential customer utility rates. Both methodologies require estimating and quantifying the value of the energy impact associated with energy efficiency measures over the life of the measures (30 years) as compared to the prescriptive Title 24 requirements.

Cost-effectiveness is presented using both lifecycle net present value (NPV) savings and benefit-to-cost (B/C) ratio metrics, which represent the cost-effectiveness of a measure over a 30-year lifetime taking into account discounting of future savings and costs.

- **Net Present Value (NPV) Savings:** NPV benefits minus NPV costs is reported as a cost effectiveness metric. If the net savings of a measure or package is positive, it is considered cost effective. Negative savings represent net costs. A measure that has negative energy cost benefits (energy cost increase) can still be cost effective if the costs to implement the measure are more negative (i.e., material and maintenance cost savings).
- **Benefit-to-Cost (B/C) Ratio:** Ratio of the present value of all benefits to the present value of all costs over 30 years (NPV benefits divided by NPV costs). The criteria for cost effectiveness is a B/C greater than 1.0. A value of one indicates the NPV of the savings over the life of the measure is equivalent to the NPV of the lifetime incremental cost of that measure. A value greater than one represents a positive return on investment. The B/C ratio is calculated according to Equation 1.

### Equation 1

$$\text{Benefit – to – Cost Ratio} = \frac{\text{NPV of lifetime benefit}}{\text{NPV of lifetime cost}}$$

Improving the efficiency of a project often requires an initial incremental investment. In most cases the benefit is represented by annual “On-Bill” utility or TDV savings, and the cost by incremental first cost and replacement costs. However, some packages result in initial construction cost savings (negative incremental cost), and either energy cost savings (positive benefits), or increased energy costs (negative benefits). In cases where both construction costs and energy-related savings are negative, the construction cost savings are treated as the ‘benefit’ while the increased energy costs are the ‘cost.’ In cases where a measure or package is cost-effective immediately (i.e. upfront construction cost savings and lifetime energy cost savings), B/C ratio cost-effectiveness is represented by “>1”. Because of these situations, NPV savings are also reported, which, in these cases, are positive values.

<sup>1</sup> PG&E Rule 15: [https://www.pge.com/tariffs/tm2/pdf/GAS\\_RULES\\_15.pdf](https://www.pge.com/tariffs/tm2/pdf/GAS_RULES_15.pdf)

SoCalGas Rule 20: <https://www.socalgas.com/regulatory/tariffs/tm2/pdf/20.pdf>

SDG&E Rule 15: [http://regarchive.sdge.com/tm2/pdf/GAS\\_GAS-RULES\\_GRULE15.pdf](http://regarchive.sdge.com/tm2/pdf/GAS_GAS-RULES_GRULE15.pdf)



The lifetime costs or benefits are calculated according to Equation 2.

### Equation 2

$$PV \text{ of lifetime cost/benefit} = \sum_{t=1}^n \text{Annual cost/benefit}_t * (1 + r)^t$$

Where:

- $n$  = analysis term
- $r$  = real discount rate
- $t$  = year at which cost/benefit is incurred

The following summarizes the assumptions applied in this analysis to both methodologies.

- Analysis term of 30 years
- Real discount rate of 3% (does not include inflation)

#### 2.5.1 On-Bill Customer Lifecycle Cost

Residential utility rates were used to calculate utility costs for all cases and determine On-Bill customer cost-effectiveness for the proposed packages. Utility costs of the nonresidential spaces were not evaluated in this study, only apartment and water heating energy use. The Statewide Reach Code Team obtained the recommended utility rates from each IOU based on the assumption that the reach codes go into effect in 2020. Annual utility costs were calculated using hourly electricity and gas output from CBECC-Com, and applying the utility tariffs summarized in Table 6. Appendix B – Utility Tariff Details includes details on the utility rate schedules used for this study. The applicable residential time-of-use (TOU) rate was applied to all cases. For cases with PV generation, the approved NEM2 tariffs were applied along with minimum daily use billing and mandatory non-bypassable charges. For the PV cases annual electric production was always less than annual electricity consumption; and therefore, no credits for surplus generation were necessary. Future changes to the NEM tariffs are likely; however, there is a lot of uncertainty about what those changes will be and if they will become effective during the 2019 Title 24 code cycle (2020-2022).

Based on guidance from the IOUs, the residential electric TOU tariffs that apply to individually metered residential apartments were also used to calculate electricity costs for the central water heating systems. Where baseline allowances are included in the tariffs (SCE TOU-D and SDG&E TOU-DR1) the allowances were applied on a per unit basis for all-electric service.

Based on guidance from the IOUs, master metered multifamily service gas tariffs were used to calculate gas costs for the central water heating systems. The baseline quantities were applied on a per unit basis, as is defined in the schedules, and when available water heating only baseline values were used.

Utility rates were applied to each climate zone based on the predominant IOU serving the population of each zone according to Table 6. Climate Zones 10 and 14 are evaluated with both SCE/SoCalGas and SDG&E tariffs since each utility has customers within these climate zones. Climate Zone 5 is evaluated under both PG&E and SoCalGas natural gas rates. Two municipal utility rates were also evaluated, Sacramento Municipal Utility District (SMUD) in Climate Zone 12 and City of Palo Alto Utilities (CPAU) in Climate Zone 4.



**Table 6: IOU Utility Tariffs Applied Based on Climate Zone**

Climate Zones	Electric/Gas Utility	Electricity (Apartment Use)	Electricity (Central Water Heating)	Natural Gas (Central Water Heating) <sup>1</sup>
1-5, 11-13, 16	PG&E	E-TOU-C	E-TOU-C	PG&E GM
5	PG&E/SoCalGas			SoCalGas GM-E
6, 8-10, 14,15	SCE/SoCalGas	TOU-D (Option 4-9)	TOU-D (Option 4-9)	SoCalGas GM-E
7, 10, 14	SDG&E	TOU-DR1	TOU-DR1	SDG&E GM
12	SMUD/PG&E	R-TOD (RT02)	GSN-T	PG&E GM
4	CPAU	E-1	E-2	G-2

<sup>1</sup> These rates are allowed assuming no gas is used in the apartments.

Utility rates are assumed to escalate over time, using assumptions from research conducted by Energy and Environmental Economics (E3) in the 2019 study Residential Building Electrification in California (Energy & Environmental Economics, 2019). Escalation of natural gas rates between 2019 and 2022 is based on the currently filed General Rate Cases (GRCs) for PG&E, SoCalGas and SDG&E. From 2023 through 2025, gas rates are assumed to escalate at 4% per year above inflation, which reflects historical rate increases between 2013 and 2018. Escalation of electricity rates from 2019 through 2025 is assumed to be 2% per year above inflation, based on electric utility estimates. After 2025, escalation rates for both natural gas and electric rates are assumed to drop to a more conservative 1% escalation per year above inflation for long-term rate trajectories beginning in 2026 through 2050. See Appendix B – Utility Tariff Details for additional details.

### 2.5.2 TDV Lifecycle Cost

Cost-effectiveness was also assessed using the Energy Commission’s TDV LCC methodology. TDV is a normalized monetary format developed and used by the Energy Commission for comparing electricity and natural gas savings, and it considers the cost of electricity and natural gas consumed during different times of the day and year. The 2019 TDV values are based on long term discounted costs of 30 years for all residential measures. The CBECC-Com simulation software results are expressed in terms of TDV kBtus. The present value of the energy cost savings in dollars is calculated by multiplying the TDV kBtu savings by a net present value (NPV) factor, also developed by the Energy Commission. The 30-year NPV factor is \$0.154/TDV kBtu for nonresidential projects under 2019 Title 24.

Like the customer B/C ratio, a TDV B/C ratio value of one indicates the savings over the life of the measure are equivalent to the incremental cost of that measure. A value greater than one represents a positive return on investment. The ratio is calculated according to Equation 3.

#### Equation 3

$$TDV \text{ Benefit} - \text{to} - \text{Cost Ratio} = \frac{TDV \text{ energy savings} * NPV \text{ factor}}{NPV \text{ of lifetime incremental cost}}$$

### 2.6 Greenhouse Gas Emissions

Equivalent CO2 emission savings were calculated based on estimates from Zero Code reports available in CBECC-Com simulation software.<sup>2</sup> Electricity emissions vary by region and by hour of the year, accounting for time dependent energy use and carbon emissions based on source emissions, including renewable portfolio standard

<sup>2</sup> More information at: : <https://zero-code.org/wp-content/uploads/2018/11/ZERO-Code-TSD-California.pdf>



projections. Two distinct hourly profiles, one for Climate Zones 1 through 5 and 11 through 13 and another for Climate Zones 6 through 10 and 14 through 16. For natural gas a fixed factor of 0.005307 metric tons/therm is used. To compare the mixed fuel and all-electric cases side-by-side, greenhouse gas (GHG) emissions are presented as CO<sub>2</sub>-equivalent emissions per dwelling unit.

### 3 Results

The primary objective of the evaluation is to identify cost-effective, non-preempted performance targets for mid-rise multifamily buildings, under both mixed-fuel and all-electric cases, to support the design of local ordinances requiring new mid-rise residential buildings to exceed the minimum state requirements. The packages presented are representative examples of designs and measures that can be used to meet the requirements. In practice, a builder can use any combination of non-preempted or preempted compliant measures to meet the requirements.

This analysis evaluated a package of efficiency measures applied to a mixed-fuel design and a similar package for an all-electric design. Each design was evaluated using the predominant utility rates in all 16 California climate zones. Solar PV was also added to the efficiency packages and a sensitivity analysis was conducted at various PV system capacities to optimize cost-effectiveness.

Although some of the efficiency measures evaluated were not cost-effective and were eliminated, the following measures are included in at least one package:

- Improved fenestration
- Wall insulation
- Low pressure-drop distribution system
- HERS verified pipe insulation

The following measures were evaluated but were found to not be cost-effective and were not included in any of the packages.

- Solar thermal system with higher solar fraction than prescriptive requirements
- Drain water heat recovery

Cost-effectiveness results for the all-electric case are based upon the clustered HPWH approach only. Lower first costs with the clustered approach resulted in better cost-effectiveness than the central HPWH design.

#### 3.1 Mid-Rise Multifamily Results

Table 7 and Table 9 present results for the mixed-fuel and all-electric packages, respectively. Each table shows cost-effectiveness results for **Efficiency Only** packages and **Efficiency + PV** packages (with a 17.6 kW<sub>DC</sub> PV system sized based on 0.2 kW<sub>DC</sub> per apartment). Both mixed-fuel and all-electric results are relative to the mixed-fuel 2019 Title 24 prescriptive baseline. B/C ratios for all packages are presented according to both the On-Bill and TDV methodologies for the mixed-fuel and the all-electric cases, respectively. Detailed results are presented in *Appendix D – Detailed Results Mixed-Fuel* and *Appendix E – Detailed Results All-Electric*.

##### **Efficiency Only:**

Compliance margins for the **Mixed-Fuel Efficiency Only** cases range from 5% to 8%, which meets the CALGreen Tier 1 energy performance requirement for high-rise residential buildings. **Mixed-Fuel Efficiency Only** cases are cost-effective based on TDV in all climate zones except for 1 and 16. The cases are cost-effective from an On-Bill perspective in all climate zones except 1.

The **All-Electric Efficiency Only** package does not meet minimum code requirements in Climate Zones 1 and 16. Compliance margins for all other climate zones range from 1% to 5%. **All-Electric Efficiency Only** cases are cost-

effective in all climate zones based on TDV. Cost-effectiveness from an On-Bill perspective is favorable in all climate zones except 1, 16, and 5 in SCG territory.

**Efficiency + PV:**

Several PV system size options were evaluated for the **Efficiency + PV** packages. Of the PV system sizes evaluated, 0.2 kW<sub>DC</sub> per apartment represents the smallest system that resulted in B/C ratios greater than one based on both metrics in all climate zones for the mixed-fuel scenario. Adding a 0.1 kW<sub>DC</sub> per apartment in the all-electric cases, resulted in B/C ratios greater than one in all climate zones.

Table 11 and Table 12 describe the efficiency measures included in the mixed-fuel and all-electric packages, respectively.





**Table 7: Mixed-Fuel Package Results: Efficiency Only (SAVINGS/COST PER APARTMENT)**

Climate Zone	Elec Utility	Gas Utility	Comp. Margin	Total Gas Savings (therms)	Total Electric Savings (kWh)	GHG Reductions (lb. CO2)	Savings (2020 PV\$)		Incremental Cost (2020 PV\$)	B/C Ratio <sup>1</sup>		NPV	
							Utility Cost Savings	TDV Savings		On-Bill	TDV	On-Bill	TDV
CZ01	PGE	PGE	5.8%	0	26	18	\$133	\$105	\$304	0.44	0.35	(\$171)	(\$199)
CZ02	PGE	PGE	5.9%	0	47	29	\$391	\$285	\$144	2.72	1.98	\$248	\$141
CZ03	PGE	PGE	6.7%	0	44	27	\$345	\$226	\$144	2.40	1.57	\$202	\$82
CZ04	PGE	PGE	6.6%	0	61	37	\$465	\$331	\$144	3.24	2.31	\$321	\$188
CZ04-2	CPAU	CPAU	6.6%	0	61	37	\$248	\$331	\$144	1.73	2.31	\$104	\$188
CZ05	PGE	PGE	6.7%	0	42	24	\$320	\$206	\$144	2.22	1.43	\$176	\$62
CZ05-2	PGE	SCG	6.7%	0	42	24	\$320	\$206	\$144	2.22	1.43	\$176	\$62
CZ06	SCE	SCG	7.1%	0	74	42	\$424	\$351	\$144	2.95	2.44	\$280	\$207
CZ07	SDGE	SDGE	7.6%	0	81	48	\$593	\$374	\$144	4.13	2.60	\$449	\$230
CZ08	SCE	SCG	7.0%	0	84	50	\$484	\$420	\$144	3.37	2.92	\$341	\$276
CZ09	SCE	SCG	6.5%	0	83	51	\$468	\$441	\$144	3.26	3.06	\$324	\$297
CZ10	SCE	SCG	6.5%	0	82	50	\$410	\$427	\$144	2.85	2.97	\$266	\$283
CZ10-2	SDGE	SDGE	6.5%	0	82	50	\$599	\$427	\$144	4.16	2.97	\$455	\$283
CZ11	PGE	PGE	6.8%	0	104	70	\$637	\$635	\$625	1.02	1.02	\$11	\$10
CZ12	PGE	PGE	6.8%	0	93	60	\$572	\$568	\$304	1.88	1.87	\$268	\$265
CZ12-2	SMUD	PGE	6.8%	0	93	71	\$319	\$568	\$304	1.05	1.87	\$15	\$265
CZ13	PGE	PGE	7.3%	0	132	89	\$798	\$779	\$625	1.28	1.25	\$173	\$154
CZ14	SCE	SCG	6.0%	0	80	49	\$407	\$449	\$304	1.34	1.48	\$103	\$145
CZ14-2	SDGE	SDGE	6.0%	0	80	49	\$576	\$449	\$304	1.90	1.48	\$273	\$145
CZ15	SCE	SCG	6.8%	0	145	93	\$719	\$802	\$625	1.15	1.28	\$94	\$177
CZ16	PGE	PGE	7.4%	0	117	76	\$646	\$563	\$625	1.03	0.90	\$21	(\$62)

<sup>1</sup> Values in red indicate B/C ratios less than 1.



**Table 8: Mixed-Fuel Package Results: PV + Efficiency 0.2 kW<sub>DC</sub> per Apartment (SAVINGS/COST PER APARTMENT)**

Climate Zone	Elec Utility	Gas Utility	Comp. Margin	Total Gas Savings (therms)	Total Electric Savings (kWh)	GHG Reductions (lb. CO2)	Savings (2020 PV\$)		Incremental Cost (2020 PV\$)	B/C Ratio <sup>1</sup>		NPV	
							Utility Cost Savings	TDV Savings		On-Bill	TDV	On-Bill	TDV
CZ01	PGE	PGE	5.8%	0	291	131	\$1,637	\$1,090	\$937	1.75	1.16	\$701	\$153
CZ02	PGE	PGE	5.9%	0	360	163	\$2,431	\$1,469	\$777	3.13	1.89	\$1,655	\$692
CZ03	PGE	PGE	6.7%	0	359	161	\$2,400	\$1,397	\$777	3.09	1.80	\$1,624	\$620
CZ04	PGE	PGE	6.6%	0	385	176	\$2,579	\$1,562	\$777	3.32	2.01	\$1,802	\$785
CZ04-2	CPAU	CPAU	6.6%	0	61	176	\$1,335	\$1,562	\$777	1.72	2.01	\$558	\$785
CZ05	PGE	PGE	6.7%	0	379	168	\$2,480	\$1,461	\$777	3.19	1.88	\$1,704	\$685
CZ05-2	PGE	SCG	6.7%	0	379	168	\$2,480	\$1,461	\$777	3.19	1.88	\$1,704	\$685
CZ06	SCE	SCG	7.1%	0	392	178	\$1,987	\$1,587	\$777	2.56	2.04	\$1,210	\$810
CZ07	SDGE	SDGE	7.6%	0	411	189	\$2,770	\$1,647	\$777	3.57	2.12	\$1,993	\$870
CZ08	SCE	SCG	7.0%	0	402	186	\$2,059	\$1,708	\$777	2.65	2.20	\$1,282	\$931
CZ09	SCE	SCG	6.5%	0	410	192	\$1,876	\$1,742	\$777	2.41	2.24	\$1,099	\$965
CZ10	SCE	SCG	6.5%	0	409	190	\$1,797	\$1,681	\$777	2.31	2.16	\$1,020	\$904
CZ10-2	SDGE	SDGE	6.5%	0	409	190	\$2,646	\$1,681	\$777	3.41	2.16	\$1,869	\$904
CZ11	PGE	PGE	6.8%	0	422	206	\$2,438	\$1,877	\$1,258	1.94	1.49	\$1,180	\$619
CZ12	PGE	PGE	6.8%	0	406	193	\$2,352	\$1,794	\$937	2.51	1.91	\$1,415	\$857
CZ12-2	SMUD	PGE	6.8%	0	406	193	\$1,226	\$1,794	\$937	1.31	1.91	\$289	\$857
CZ13	PGE	PGE	7.3%	0	441	221	\$2,548	\$1,965	\$1,258	2.03	1.56	\$1,290	\$707
CZ14	SCE	SCG	6.0%	0	439	201	\$1,923	\$1,901	\$937	2.05	2.03	\$987	\$964
CZ14-2	SDGE	SDGE	6.0%	0	439	201	\$2,819	\$1,901	\$937	3.01	2.03	\$1,882	\$964
CZ15	SCE	SCG	6.8%	0	478	234	\$2,128	\$2,110	\$1,258	1.69	1.68	\$870	\$852
CZ16	PGE	PGE	7.4%	0	457	222	\$2,567	\$1,818	\$1,258	2.04	1.44	\$1,309	\$560

<sup>1</sup> Values in red indicate B/C ratios less than 1.



**Table 9: All-Electric Package Results: Efficiency Only (SAVINGS/COSTS PER APARTMENT)**

Climate Zone	Elec Utility	Gas Utility	Comp. Margin	Total Gas Savings (therms)	Total Electric Savings (kWh)	GHG Reductions (lb. CO2)	Savings (2020 PV\$)		Incremental Cost (2020 PV\$)	B/C Ratio <sup>1,2</sup>		NPV	
							Utility Cost Savings	TDV Savings		On-Bill	TDV	On-Bill	TDV
CZ01	PGE	PGE	-0.4%	125	-873	1040	-\$674	\$199	-\$446	0.7	>1	(\$228)	\$645
CZ02	PGE	PGE	1.6%	114	-762	971	-\$238	\$528	-\$606	2.5	>1	\$368	\$1,134
CZ03	PGE	PGE	1.1%	115	-767	975	-\$287	\$390	-\$606	2.1	>1	\$319	\$996
CZ04	PGE	PGE	3.4%	111	-714	952	-\$102	\$625	-\$606	6.0	>1	\$504	\$1,231
CZ04-2	CPAU	CPAU	3.4%	111	-714	952	\$345	\$625	-\$606	>1	>1	\$951	\$1,231
CZ05	PGE	PGE	1.3%	117	-788	991	-\$350	\$391	-\$606	1.7	>1	\$255	\$996
CZ05-2	PGE	SCG	1.3%	117	-788	991	-\$827	\$391	-\$606	0.7	>1	(\$221)	\$996
CZ06	SCE	SCG	3.7%	107	-670	933	\$153	\$612	-\$606	>1	>1	\$759	\$1,218
CZ07	SDGE	SDGE	4.8%	106	-653	930	-\$58	\$665	-\$606	10.4	>1	\$547	\$1,271
CZ08	SCE	SCG	3.9%	104	-633	912	\$227	\$693	-\$606	>1	>1	\$833	\$1,298
CZ09	SCE	SCG	3.8%	104	-633	912	\$212	\$739	-\$606	>1	>1	\$817	\$1,345
CZ10	SCE	SCG	1.8%	90	-626	743	-\$214	\$396	-\$853	4.0	>1	\$639	\$1,249
CZ10-2	SDGE	SDGE	1.8%	90	-626	743	-\$478	\$396	-\$853	1.8	>1	\$375	\$1,249
CZ11	PGE	PGE	2.0%	91	-619	769	-\$241	\$430	-\$371	1.5	>1	\$130	\$802
CZ12	PGE	PGE	1.4%	94	-662	773	-\$414	\$288	-\$693	1.7	>1	\$279	\$980
CZ12-2	SMUD	PGE	1.4%	94	-662	773	\$1,060	\$288	-\$693	>1	>1	\$1,753	\$980
CZ13	PGE	PGE	2.6%	90	-579	777	-\$62	\$505	-\$371	6.0	>1	\$309	\$876
CZ14	SCE	SCG	1.1%	92	-653	759	-\$258	\$305	-\$693	2.7	>1	\$435	\$998
CZ14-2	SDGE	SDGE	1.1%	92	-653	759	-\$532	\$305	-\$693	1.3	>1	\$161	\$998
CZ15	SCE	SCG	4.4%	74	-409	679	\$332	\$832	-\$371	>1	>1	\$704	\$1,203
CZ16	PGE	PGE	-5.8%	108	-777	895	-\$621	\$127	-\$371	0.6	>1	(\$250)	\$498

<sup>1</sup> Values in red indicate B/C ratios less than 1.

<sup>2</sup> ">1" indicates cases where there are both incremental measure cost savings and energy cost savings.



**Table 10: All-Electric Package Results: PV + Efficiency 0.1 kW<sub>DC</sub> per Apartment (SAVINGS/COSTS PER APARTMENT)**

Climate Zone	Elec Utility	Gas Utility	Comp. Margin	Total Gas Savings (therms)	Total Electric Savings (kWh)	GHG Reductions (lb. CO <sub>2</sub> )	Savings (2020 PV\$)		Incremental Cost (2020 PV\$)	B/C Ratio <sup>1,2</sup>		NPV	
							Utility Cost Savings	TDV Savings		On-Bill	TDV	On-Bill	TDV
CZ01	PGE	PGE	-0.4%	125	-741	1,097	\$78	\$692	-\$129	>1	>1	\$208	\$821
CZ02	PGE	PGE	1.6%	114	-606	1,038	\$782	\$1,120	-\$289	>1	>1	\$1,071	\$1,409
CZ03	PGE	PGE	1.1%	115	-609	1,042	\$741	\$975	-\$289	>1	>1	\$1,030	\$1,264
CZ04	PGE	PGE	3.4%	111	-552	1,021	\$955	\$1,240	-\$289	>1	>1	\$1,244	\$1,529
CZ04-2	CPAU	CPAU	3.4%	111	-714	1,021	\$904	\$1,240	-\$289	>1	>1	\$1,194	\$1,529
CZ05	PGE	PGE	1.3%	117	-619	1,063	\$730	\$1,018	-\$289	>1	>1	\$1,019	\$1,307
CZ05-2	PGE	SCG	1.3%	117	-619	1,063	\$254	\$1,018	-\$289	>1	>1	\$543	\$1,307
CZ06	SCE	SCG	3.7%	107	-512	1,001	\$935	\$1,231	-\$289	>1	>1	\$1,224	\$1,520
CZ07	SDGE	SDGE	4.8%	106	-488	1,000	\$1,049	\$1,302	-\$289	>1	>1	\$1,339	\$1,591
CZ08	SCE	SCG	3.9%	104	-474	981	\$1,014	\$1,337	-\$289	>1	>1	\$1,304	\$1,626
CZ09	SCE	SCG	3.8%	104	-469	983	\$924	\$1,390	-\$289	>1	>1	\$1,213	\$1,679
CZ10	SCE	SCG	1.8%	90	-463	813	\$480	\$1,023	-\$536	>1	>1	\$1,016	\$1,559
CZ10-2	SDGE	SDGE	1.8%	90	-463	813	\$546	\$1,023	-\$536	>1	>1	\$1,082	\$1,559
CZ11	PGE	PGE	2.0%	91	-460	837	\$660	\$1,052	-\$55	>1	>1	\$714	\$1,106
CZ12	PGE	PGE	1.4%	94	-505	839	\$476	\$900	-\$376	>1	>1	\$852	\$1,276
CZ12-2	SMUD	PGE	1.4%	94	-505	839	\$1,513	\$900	-\$376	>1	>1	\$1,890	\$1,276
CZ13	PGE	PGE	2.6%	90	-424	843	\$813	\$1,098	-\$55	>1	>1	\$867	\$1,153
CZ14	SCE	SCG	1.1%	92	-473	835	\$500	\$1,031	-\$376	>1	>1	\$877	\$1,407
CZ14-2	SDGE	SDGE	1.1%	92	-473	835	\$589	\$1,031	-\$376	>1	>1	\$965	\$1,407
CZ15	SCE	SCG	4.4%	74	-242	750	\$1,037	\$1,485	-\$55	>1	>1	\$1,091	\$1,540
CZ16	PGE	PGE	-5.8%	108	-608	969	\$339	\$754	-\$55	>1	>1	\$394	\$809

<sup>1</sup> Values in red indicate B/C ratios less than 1.

<sup>2</sup> ">1" indicates cases where there are both incremental measure cost savings and energy cost savings.



**Table 11: Mixed-Fuel Measure Package Summary**

Climate Zone	Compliance Margin	MEASURE SPECIFICATION				
		Window U-value	Window SHGC	Add Wall Ins.	Fan Watt Draw	HERS Pipe Ins.
CZ01	5.8%			+ 1"	0.25 W/cfm	No
CZ02	5.9%		0.22		0.25 W/cfm	No
CZ03	6.7%		0.22		0.25 W/cfm	No
CZ04	6.6%		0.22		0.25 W/cfm	No
CZ05	6.7%		0.22		0.25 W/cfm	No
CZ06	7.1%		0.22		0.25 W/cfm	No
CZ07	7.6%		0.22		0.25 W/cfm	No
CZ08	7.0%		0.22		0.25 W/cfm	No
CZ09	6.5%		0.22		0.25 W/cfm	No
CZ10	6.5%		0.22		0.25 W/cfm	No
CZ11	6.8%	0.25	0.22	+ 1"	0.25 W/cfm	No
CZ12	7.3%		0.22	+ 1"	0.25 W/cfm	No
CZ13	7.3%	0.25	0.22	+ 1"	0.25 W/cfm	No
CZ14	6.8%		0.22	+ 1"	0.25 W/cfm	No
CZ15	6.8%	0.25	0.22	+ 1"	0.25 W/cfm	No
CZ16	7.4%	0.25	0.22	+ 1"	0.25 W/cfm	No

**Table 12: All-Electric Measure Package Summary**

Climate Zone	Compliance Margin	MEASURE SPECIFICATION				
		Window U-value	Window SHGC	Add Wall Ins.	Fan Watt Draw	HERS Pipe Ins.
CZ01	-0.4%			+ 1"	0.25 W/cfm	Yes
CZ02	1.6%		0.22		0.25 W/cfm	Yes
CZ03	1.1%		0.22		0.25 W/cfm	Yes
CZ04	3.4%		0.22		0.25 W/cfm	Yes
CZ05	1.3%		0.22		0.25 W/cfm	Yes
CZ06	3.7%		0.22		0.25 W/cfm	Yes
CZ07	4.8%		0.22		0.25 W/cfm	Yes
CZ08	3.9%		0.22		0.25 W/cfm	Yes
CZ09	3.8%		0.22		0.25 W/cfm	Yes
CZ10	1.8%		0.22		0.25 W/cfm	Yes
CZ11	2.0%	0.25	0.22	+ 1"	0.25 W/cfm	Yes
CZ12	2.0%		0.22	+ 1"	0.25 W/cfm	Yes
CZ13	2.6%	0.25	0.22	+ 1"	0.25 W/cfm	Yes
CZ14	2.0%		0.22	+ 1"	0.25 W/cfm	Yes
CZ15	4.4%	0.25	0.22	+ 1"	0.25 W/cfm	Yes
CZ16	-5.8%	0.25	0.22	+ 1"	0.25 W/cfm	Yes



## 4 Conclusions & Summary

This report evaluated the feasibility and cost-effectiveness of “above code” performance specifications for newly constructed mid-rise multifamily buildings. The analysis included application of efficiency measures, electric appliances, and PV in all 16 California climate zones, and found cost-effective packages across the state. For the building designs and climate zones where cost-effective packages were identified, the results of this analysis can be used by local jurisdictions to support the adoption of reach codes. Cost-effectiveness was evaluated according to two metrics: On-Bill customer lifecycle benefit-to-cost ratio and TDV lifecycle benefit-to-cost ratio.

For mixed-fuel buildings, this analysis demonstrates that there are cost-effective **Efficiency Only** packages that achieve a minimum 5% compliance margin in most climate zones. The exception is Climate Zone 1 where the package was not cost-effective based on either the TDV or the On-Bill methodology. In all other cases the package is cost-effective for at least one of the metrics.

When 0.1 kW<sub>DC</sub> per apartment is included, all climate zones are cost-effective based on at least one of the metrics. The addition of 0.1 kW<sub>DC</sub> per apartment, or 8.8 kW<sub>DC</sub> total for the building, results in an incremental cost for the PV system of \$27,855. When 0.2 kW<sub>DC</sub> per apartment is included, all climate zones are cost-effective based on both metrics. The addition of 0.2 kW<sub>DC</sub> per apartment, or 17.6 kW<sub>DC</sub> for the building, results in an incremental cost for the PV system of \$55,711.

This study evaluated electrification of residential loads in new mid-rise multifamily buildings. Based on typical construction across California, the basecase condition incorporated all electric appliances within the apartment spaces. As a result, only central water heating was converted from natural gas to electric as part of this analysis. For all-electric buildings, this analysis demonstrates that there are cost-effective **All-Electric Efficiency Only** packages that meet minimum Title 24 code compliance in all climate zones except 1 and 16. The package is cost-effective based on the TDV methodology in all climate zones. It is cost-effective based on the On-Bill methodology in Climate Zones 2 through 15, except for Climate Zones 5 in SCG territory.

When 0.1 kW<sub>DC</sub> per apartment is included, all climate zones are cost-effective based on both metrics. The addition of 0.1 kW<sub>DC</sub> per apartment, or 8.8 kW<sub>DC</sub> for the building, results in an incremental cost for the PV system of \$27,855.

### Additional considerations

- This study found that electrification of central domestic hot water loads, in combination with efficiency measures, can result in a benefit to the consumer through lower utility bills under certain electricity and gas tariff scenarios (Climate Zones 6, 8, 9, 15, 4 in CPAU territory, and 12 in SMUD territory territory). The all-electric results demonstrate a trend with On-Bill cost-effectiveness across the different electric utilities. Net Present Value in SCE and SDG&E territories, as well as SMUD and CPAU territories, are typically higher than the cases in PG&E territory. This indicates that rate design can play an important role in encouraging or discouraging electrification.
- This study did not evaluate federally preempted high efficiency appliances. Specifying high efficiency equipment is a viable approach to meeting Title 24 code compliance and local ordinance requirements and is commonly used by project teams. Other studies have found that efficiency packages and electrification packages that employ high efficiency equipment can be quite cost-effective ((Statewide Reach Code Team, 2019b), (Energy & Environmental Economics. 2019)).
- If PV capacity is added to both the mixed-fuel and all-electric efficiency packages, all cases are cost-effective based on at least one of the two evaluated metrics. In some cases, cost-effectiveness improves, and in other cases it decreases relative to the case with efficiency and/or electrification measures only. The cost-effectiveness of adding PV up to 1 kW per apartment, as an independent measure, results in On-Bill benefit-to-cost ratios between 2.3 and 3.1 for PGE territory, 2.1 to 2.3 for SCE territory, and 3.2 to 3.5 for SDG&E territory. The TDV B/C ratio for PV alone is approximately 2.0 for most climate zones



for all service territories. Adding PV in addition to the efficiency packages improves cost-effectiveness where the B/C ratios for the efficiency measures alone are lower than the B/C ratios for PV alone, and vice versa where they are higher. Annual basecase electricity costs and annual utility savings from PV are lower in SCE territory than in PG&E and SDG&E territories. This is due to lower off-peak cost and a bigger difference in peak versus off-peak rate for the TOU-D SCE electricity rate tariff. Most PV production occurs during off-peak times (4 pm to 9 pm peak period).

Table 13 summarizes compliance margin and cost-effectiveness results for the mixed-fuel and all-electric cases. Compliance margin is reported in the cells and cost-effectiveness is indicated by the color of the cell according to the following:

- Cells highlighted in green depict a positive compliance margin and cost-effective results using both On-Bill and TDV approaches.
- Cells highlighted in yellow depict a positive compliance margin and cost-effective results using either the On-Bill or TDV approach but not both.
- Cells not highlighted either depict a negative compliance margin (red text) or a package that was not cost-effective using either the On-Bill or TDV approach.

For more detail on the results, please refer to *Section 3.1 Mid-Rise Multifamily Results, Appendix D – Detailed Results Mixed-Fuel* and *Appendix E – Detailed Results All-Electric*.

**Table 13: Mid-Rise Multifamily Summary of Compliance Margin and Cost-Effectiveness**

Climate Zone	Elec Utility	Gas Utility	Mixed-Fuel			All-Electric				
			No PV	0.1 kW <sub>DC</sub> /Apt	0.2 kW <sub>DC</sub> /Apt	0.3 kW <sub>DC</sub> /Apt	No PV	0.1 kW <sub>DC</sub> /Apt	0.2 kW <sub>DC</sub> /Apt	0.3 kW <sub>DC</sub> /Apt
CZ01	PGE	PGE	5.8%	5.8%	5.8%	5.8%	-0.4%	-0.4%	-0.4%	-0.4%
CZ02	PGE	PGE	5.9%	5.9%	5.9%	5.9%	1.6%	1.6%	1.6%	1.6%
CZ03	PGE	PGE	6.7%	6.7%	6.7%	6.7%	1.1%	1.1%	1.1%	1.1%
CZ04	PGE	PGE	6.6%	6.6%	6.6%	6.6%	3.4%	3.4%	3.4%	3.4%
CZ04-2	CPAU	CPAU	6.6%	6.6%	6.6%	6.6%	3.4%	3.4%	3.4%	3.4%
CZ05	PGE	PGE	6.7%	6.7%	6.7%	6.7%	1.3%	1.3%	1.3%	1.3%
CZ05-2	PGE	SCG	6.7%	6.7%	6.7%	6.7%	1.3%	1.3%	1.3%	1.3%
CZ06	SCE	SCG	7.1%	7.1%	7.1%	7.1%	3.7%	3.7%	3.7%	3.7%
CZ07	SDGE	SDGE	7.6%	7.6%	7.6%	7.6%	4.8%	4.8%	4.8%	4.8%
CZ08	SCE	SCG	7.0%	7.0%	7.0%	7.0%	3.9%	3.9%	3.9%	3.9%
CZ09	SCE	SCG	6.5%	6.5%	6.5%	6.5%	3.8%	3.8%	3.8%	3.8%
CZ10	SCE	SCG	6.5%	6.5%	6.5%	6.5%	1.8%	1.8%	1.8%	1.8%
CZ10-2	SDGE	SDGE	6.5%	6.5%	6.5%	6.5%	1.8%	1.8%	1.8%	1.8%
CZ11	PGE	PGE	6.8%	6.8%	6.8%	6.8%	2.0%	2.0%	2.0%	2.0%
CZ12	PGE	PGE	6.8%	6.8%	6.8%	6.8%	1.4%	1.4%	1.4%	1.4%
CZ12-2	SMUD	PGE	6.8%	6.8%	6.8%	6.8%	1.4%	1.4%	1.4%	1.4%
CZ13	PGE	PGE	7.3%	7.3%	7.3%	7.3%	2.6%	2.6%	2.6%	2.6%
CZ14	SCE	SCG	6.0%	6.0%	6.0%	6.0%	1.1%	1.1%	1.1%	1.1%
CZ14-2	SDGE	SDGE	6.0%	6.0%	6.0%	6.0%	1.1%	1.1%	1.1%	1.1%
CZ15	SCE	SCG	6.8%	6.8%	6.8%	6.8%	4.4%	4.4%	4.4%	4.4%
CZ16	PGE	PGE	7.4%	7.4%	7.4%	7.4%	-5.8%	-5.8%	-5.8%	-5.8%



## 5 References

- California Energy Commission. 2017. Rooftop Solar PV System. Measure number: 2019-Res-PV-D Prepared by Energy and Environmental Economics, Inc. <https://efiling.energy.ca.gov/getdocument.aspx?tn=221366>
- California Energy Commission. 2018a. 2019 Building Energy Efficiency Standards for Residential and Nonresidential Buildings. CEC-400-2018-020-CMF. December 2018. California Energy Commission. <https://www.energy.ca.gov/2018publications/CEC-400-2018-020/CEC-400-2018-020-CMF.pdf>
- California Energy Commission. 2018b. 2019 Reference Appendices. CEC-400-2018-021-CMF. December 2018. California Energy Commission. <https://www.energy.ca.gov/2018publications/CEC-400-2018-021/CEC-400-2018-021-CMF.pdf>
- California Energy Commission. 2019a. 2019 Nonresidential Alternative Calculation Method Reference Manual. CEC-400-2019-006-CMF. May 2019. California Energy Commission. <https://ww2.energy.ca.gov/2019publications/CEC-400-2019-006/CEC-400-2019-006-CMF.pdf>
- California Energy Commission. 2019b. Executive Director Determination Pursuant to Section 150.1(c)8C for Central Heat Pump Water Heating System. December 26, 2019. <https://efiling.energy.ca.gov/GetDocument.aspx?tn=231318&DocumentContentId=63067>
- Energy & Environmental Economics. 2019. Residential Building Electrification in California. April 2019. [https://www.ethree.com/wp-content/uploads/2019/04/E3\\_Residential\\_Building\\_Electrification\\_in\\_California\\_April\\_2019.pdf](https://www.ethree.com/wp-content/uploads/2019/04/E3_Residential_Building_Electrification_in_California_April_2019.pdf)
- Horii, B., E. Cutter, N. Kapur, J. Arent, and D. Conotyannis. 2014. “Time Dependent Valuation of Energy for Developing Building Energy Efficiency Standards.” [http://www.energy.ca.gov/title24/2016standards/prerulemaking/documents/2014-07-09\\_workshop/2017\\_TDV\\_Documents/](http://www.energy.ca.gov/title24/2016standards/prerulemaking/documents/2014-07-09_workshop/2017_TDV_Documents/)
- Barbose, Galen and Darghouth, Naim. 2018. Tracking the Sun. Installed Price Trends for Distributed Photovoltaic Systems in the United States – 2018 Edition. Lawrence Berkeley National Laboratory. September 2018. [https://emp.lbl.gov/sites/default/files/tracking\\_the\\_sun\\_2018\\_edition\\_final\\_0.pdf](https://emp.lbl.gov/sites/default/files/tracking_the_sun_2018_edition_final_0.pdf)
- Statewide CASE Team. 2014. Codes and Standards Enhancement (CASE) Initiative Nonresidential Opaque Envelope. December 2014. <https://title24stakeholders.com/wp-content/uploads/2019/02/2016-T24-CASE-Report-NR-Opaque-Envelope-Dec2014-V3.pdf>
- Statewide CASE Team. 2017a. Codes and Standards Enhancement (CASE) Initiative High Performance Walls – Final Report. September 2017. <http://title24stakeholders.com/wp-content/uploads/2017/09/2019-T24-CASE-Report-HPW-Final-September-2017.pdf>
- Statewide CASE Team. 2017b. Codes and Standards Enhancement (CASE) Initiative Residential High Performance Windows & Doors – Final Report. August 2017. <http://title24stakeholders.com/wp-content/uploads/2017/09/2019-T24-CASE-Report-Res-Windows-and-Doors-Final-September-2017.pdf>
- Statewide CASE Team. 2017c. Codes and Standards Enhancement (CASE) Initiative Drain Water Heat Recovery – Final Report. July 2017. <https://title24stakeholders.com/wp-content/uploads/2017/09/2019-T24-CASE-Report-DWHR-Final-September-2017.pdf>
- Statewide CASE Team. 2018. Energy Savings Potential and Cost-Effectiveness Analysis of High Efficiency Windows in California. Prepared by Frontier Energy. May 2018. <https://www.etcc-ca.com/reports/energy-savings-potential-and-cost-effectiveness-analysis-high-efficiency-windows-california>
- Statewide CASE Team. 2020. All-Electric Multifamily Compliance Pathway Draft CASE Report. <https://title24stakeholders.com/wp-content/uploads/2018/10/2022-T24-Draft-CASE-Report-MF-All-Electric.pdf>





Statewide Reach Code Team. 2019a. 2019 Nonresidential New Construction Reach Code Cost Effectiveness Study. Prepared for Southern California Edison. Prepared by TRC. July 25, 2019.

[https://localenergycodes.com/download/801/file\\_path/fieldList/2019%20NR%20NC%20Cost%20Effectiveness%20Study-2019-07-25.pdf](https://localenergycodes.com/download/801/file_path/fieldList/2019%20NR%20NC%20Cost%20Effectiveness%20Study-2019-07-25.pdf)

Statewide Reach Code Team. 2019b. 2019 Cost-effectiveness Study: Low-Rise Residential New Construction. Prepared for Pacific Gas and Electric Company. Prepared by Frontier Energy. August 1, 2019.

[https://localenergycodes.com/download/800/file\\_path/fieldList/2019%20Res%20NC%20Reach%20Codes](https://localenergycodes.com/download/800/file_path/fieldList/2019%20Res%20NC%20Reach%20Codes)

TRC. 2018. City of Palo Alto 2019 Title 24 Energy Reach Code Cost-effectiveness Analysis Draft. September 2018.

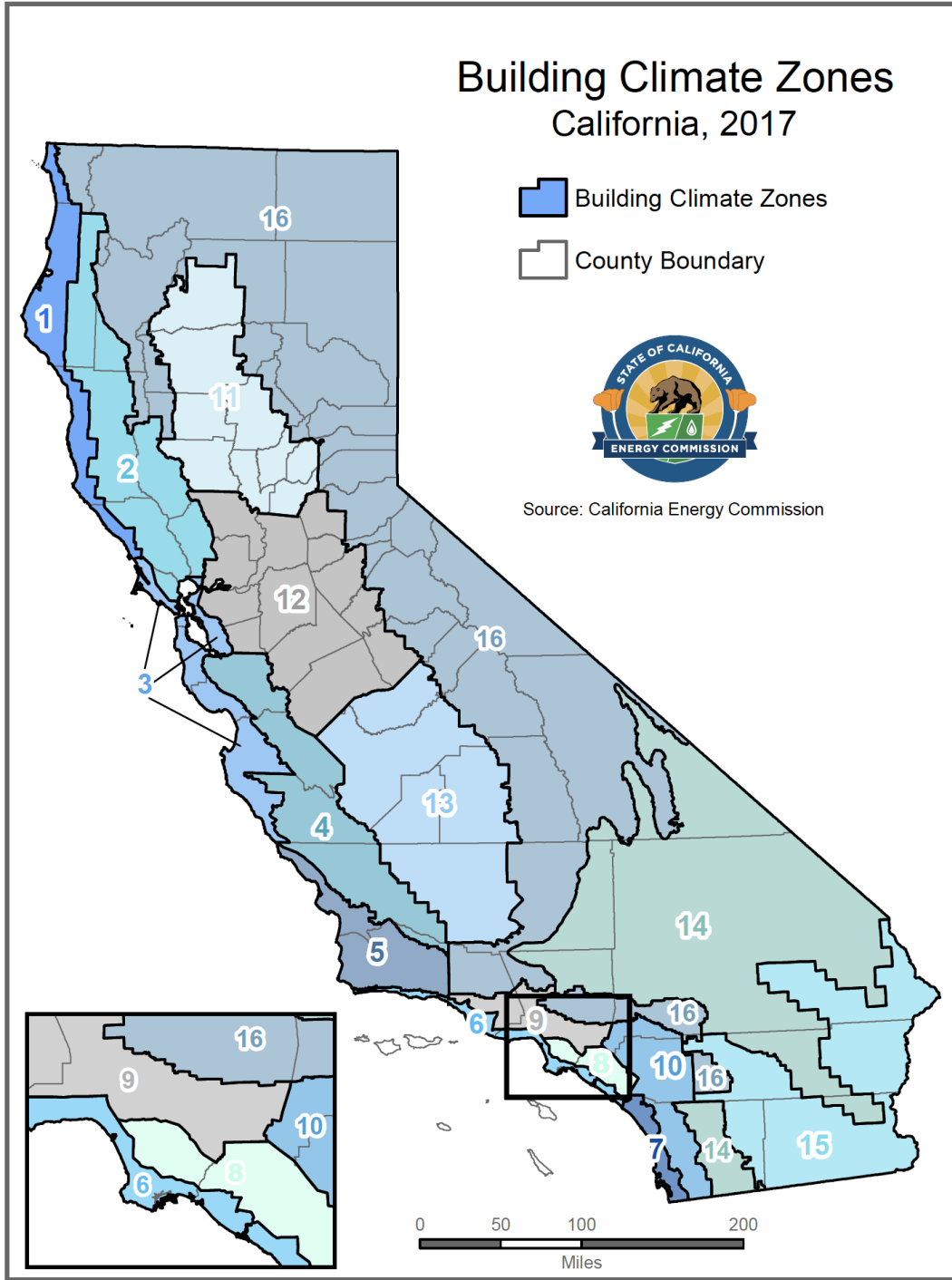
<https://cityofpaloalto.org/civicax/filebank/documents/66742>

TRC. 2019. Multifamily Prototypes. June 7, 2019. Submitted to Southern California Edison.

[https://title24stakeholders.com/wp-content/uploads/2019/06/SCE-MFModeling\\_MultifamilyPrototypesReport\\_2019-06-07\\_clean.pdf](https://title24stakeholders.com/wp-content/uploads/2019/06/SCE-MFModeling_MultifamilyPrototypesReport_2019-06-07_clean.pdf)



# Appendix A - California Climate Zone Map



**Figure 3: Map of California climate zones.** (Source, California Energy Commission<sup>3</sup>)

<sup>3</sup> [https://ww2.energy.ca.gov/maps/renewable/building\\_climate\\_zones.html](https://ww2.energy.ca.gov/maps/renewable/building_climate_zones.html)



## Appendix B – Utility Tariff Details

PG&E .....	26
SCE .....	32
SoCalGas .....	35
SDG&E.....	38
SMUD.....	42
Escalation Assumptions .....	44



**PG&E**

The following pages provide details on the PG&E electricity and natural gas tariffs applied in this study. Table 14 describes the baseline territories that were assumed for each climate zone.

**Table 14: PG&E Baseline Territory by Climate Zone**

	Baseline Territory
CZ01	V
CZ02	X
CZ03	T
CZ04	X
CZ05	T
CZ11	R
CZ12	S
CZ13	R
CZ16	Y

The PG&E monthly gas rate in \$/therm was applied on a monthly basis for the 12-month period ending April 2020 according to the rates shown in Table 15. Rates are based on historical data provided by PG&E.<sup>4</sup>

**Table 15: PG&E Monthly Gas Rate (\$/Therm)**

Month	Procurement Charge	Transportation Charge		Total Charge	
		Baseline	Excess	Baseline	Excess
Jan 2020	\$0.45813	\$0.99712	\$1.59540	\$1.45525	\$2.05353
Feb 2020	\$0.44791	\$0.99712	\$1.59540	\$1.44503	\$2.04331
Mar 2020	\$0.35346	\$1.13126	\$1.64861	\$1.48472	\$2.00207
Apr 2020	\$0.23856	\$1.13126	\$1.64861	\$1.36982	\$1.88717
May 2019	\$0.21791	\$0.99933	\$1.59892	\$1.21724	\$1.81683
June 2019	\$0.20648	\$0.99933	\$1.59892	\$1.20581	\$1.80540
July 2019	\$0.28462	\$0.99933	\$1.59892	\$1.28395	\$1.88354
Aug 2019	\$0.30094	\$0.96652	\$1.54643	\$1.26746	\$1.84737
Sept 2019	\$0.25651	\$0.96652	\$1.54643	\$1.22303	\$1.80294
Oct 2019	\$0.27403	\$0.98932	\$1.58292	\$1.26335	\$1.85695
Nov 2019	\$0.33311	\$0.96729	\$1.54767	\$1.30040	\$1.88078
Dec 2019	\$0.40178 <sup>7/</sup>	\$0.96729	\$1.54767	\$1.36907	\$1.94945

<sup>4</sup>The PG&E procurement and transportation charges were obtained from the following site:

<https://www.pge.com/tariffs/GRF.SHTML#RESGAS>





Cancelling Revised Cal. P.U.C. Sheet No. 46539-E  
 Revised Cal. P.U.C. Sheet No. 46325-E

**ELECTRIC SCHEDULE E-TOU-C** Sheet 2  
**RESIDENTIAL TIME-OF-USE (PEAK PRICING 4 - 9 p.m. EVERY DAY)**

RATES:  
 (Cont'd.)

**E-TOU-C TOTAL RATES**

Total Energy Rates (\$ per kWh)	PEAK		OFF-PEAK	
<i>Summer</i>				
Total Usage	\$0.41333	(I)	\$0.34989	(I)
Baseline Credit (Applied to Baseline Usage Only)	(\$0.08633)	(R)	(\$0.08633)	(R)
<i>Winter</i>				
Total Usage	\$0.31624	(I)	\$0.29891	(I)
Baseline Credit (Applied to Baseline Usage Only)	(\$0.08633)	(R)	(\$0.08633)	(R)
Delivery Minimum Bill Amount (\$ per meter per day)	\$0.32854			
California Climate Credit (per household, per semi-annual payment occurring in the April and October bill cycles) <sup>†</sup>	(\$35.73)			

(T)

Total bundled service charges shown on customer's bills are unbundled according to the component rates shown below. Where the delivery minimum bill amount applies, the customer's bill will equal the sum of (1) the delivery minimum bill amount plus (2) for bundled service, the generation rate times the number of kWh used. For revenue accounting purposes, the revenues from the delivery minimum bill amount will be assigned to the Transmission, Transmission Rate Adjustments, Reliability Services, Public Purpose Programs, Nuclear Decommissioning, Competition Transition Charges, Energy Cost Recovery Amount, DWR Bond, and New System Generation Charges based on kWh usage times the corresponding unbundled rate component per kWh, with any residual revenue assigned to Distribution.

<sup>†</sup> Pursuant to D.20-04-027, distribution of the October 2020 California Climate Credit will be advanced and split to the May 2020 and June 2020 bill cycles, \$17.87 and \$17.86 respectively.. (N)  
 (N)

(Continued)

Advice	5861-E-B	Issued by	Submitted	April 28, 2020
Decision		<b>Robert S. Kenney</b>	Effective	May 1, 2020
		Vice President, Regulatory Affairs	Resolution	





**Pacific Gas and  
Electric Company**  
U 39 San Francisco, California

Revised  
Revised  
Cal. P.U.C. Sheet No. 46540-E  
Cal. P.U.C. Sheet No. 46252-E

**ELECTRIC SCHEDULE E-TOU-C** Sheet 3  
RESIDENTIAL TIME-OF-USE (PEAK PRICING 4 - 9 p.m. EVERY DAY)

**RATES:** **UNBUNDLING OF E-TOU-C TOTAL RATES**  
(Cont'd.)

Energy Rates by Component (\$ per kWh)	PEAK		OFF-PEAK	
<b>Generation:</b>				
Summer (all usage)	\$0.16735	(R)	\$0.11391	(R)
Winter (all usage)	\$0.11859	(R)	\$0.10356	(R)
<b>Distribution**:</b>				
Summer (all usage)	\$0.12767	(I)	\$0.11767	(I)
Winter (all usage)	\$0.07935	(I)	\$0.07705	(I)
Conservation Incentive Adjustment (Baseline Usage)			(\$0.03294)	(I)
Conservation Incentive Adjustment (Over Baseline Usage)			\$0.05339	(I)
Transmission* (all usage)			\$0.03595	
Transmission Rate Adjustments* (all usage)			\$0.00314	
Reliability Services* (all usage)			(\$0.00066)	
Public Purpose Programs (all usage)			\$0.01298	(I)
Nuclear Decommissioning (all usage)			\$0.00101	(I)
Competition Transition Charges (all usage)			\$0.00096	(R)
Energy Cost Recovery Amount (all usage)			\$0.00005	(I)
DWR Bond (all usage)			\$0.00580	
New System Generation Charge (all usage)**			\$0.00571	(I)

\* Transmission, Transmission Rate Adjustments and Reliability Service charges are combined for presentation on customer bills.

\*\* Distribution and New System Generation Charges are combined for presentation on customer bills.

(Continued)

Advice 5861-E-B  
Decision

Issued by  
**Robert S. Kenney**  
Vice President, Regulatory Affairs

Submitted April 28, 2020  
Effective May 1, 2020  
Resolution \_\_\_\_\_





**Pacific Gas and Electric Company**  
San Francisco, California

Revised  
Cancelling Revised  
Cal. P.U.C. Sheet No. 46190-E  
Cal. P.U.C. Sheet No. 43414-E

**ELECTRIC SCHEDULE E-TOU-C** Sheet 4 (T)  
**RESIDENTIAL TIME-OF-USE (PEAK PRICING 4 - 9 p.m. EVERY DAY)**

**SPECIAL CONDITIONS:** 1. **BASELINE (TIER 1) QUANTITIES:** The following quantities of electricity are to be used to define usage eligible for the baseline credit (also see Rule 19 for additional allowances for medical needs):

**BASELINE QUANTITIES (kWh PER DAY)**

Baseline Territory*	Code B - Basic Quantities		Code H - All-Electric Quantities	
	Summer	Winter	Summer	Winter
	Tier I	Tier I	Tier I	Tier I
P	14.2	12.0	16.0	27.4
Q	10.3	12.0	8.9	27.4
R	18.6	11.3	20.9	28.1
S	15.8	11.1	18.7	24.9
T	6.8	8.2	7.5	13.6
V	7.5	8.8	10.9	16.9
W	20.2	10.7	23.6	20.0
X	10.3	10.5	8.9	15.4
Y	11.0	12.1	12.6	25.3
Z	6.2	8.1	7.0	16.5

2. **TIME PERIODS FOR E-TOU-C:** Times of the year and times of the day are defined as follows: (T)

Summer (service from June 1 through September 30):

Peak: 4:00 p.m. to 9:00 p.m. All days

Off-Peak: All other times

Winter (service from October 1 through May 31):

Peak: 4:00 p.m. to 9:00 p.m. All days

Off-Peak: All other times

\* The applicable baseline territory is described in Part A of the Preliminary Statement

(Continued)

Advice	5759-E	Issued by	Submitted	February 14, 2020
Decision	D.19-07-004	<b>Robert S. Kenney</b>	Effective	March 1, 2020
		Vice President, Regulatory Affairs	Resolution	





**Pacific Gas and Electric Company**  
 San Francisco, California

Cancelling Revised Cal. P.U.C. Sheet No. 35762-G  
 Revised Cal. P.U.C. Sheet No. 35696-G

**GAS SCHEDULE GM**  
 MASTER-METERED MULTIFAMILY SERVICE

Sheet 2

RATES: Customers on this schedule pay a Procurement Charge and a Transportation Charge, per meter, as follows:

	<u>Baseline</u>		<u>Per Therm</u>		<u>Excess</u>
<u>Procurement Charge:</u>	\$0.23856	(R)	\$0.23856		(R)
<u>Transportation Charge:</u>	<u>\$1.13126</u>		<u>\$1.64861</u>		
Total:	\$1.36982	(R)	\$1.88717		(R)

California Natural Gas Climate Credit (\$27.18)  
 (per Household, annual payment  
 occurring in the April bill cycle)

Public Purpose Program Surcharge:

Customers served under this schedule are subject to a gas Public Purpose Program (PPP) Surcharge under Schedule G-PPPS.

See Preliminary Statement, Part B for the Default Tariff Rate Components.

The Procurement Charge on this schedule is equivalent to the rate shown on informational Schedule G-CP—Gas Procurement Service to Core End-Use Customers.







**Pacific Gas and Electric Company**  
 San Francisco, California

Cancelling Revised Cal. P.U.C. Sheet No. 35447-G  
 Revised Cal. P.U.C. Sheet No. 34307-G

**GAS SCHEDULE GM**  
 MASTER-METERED MULTIFAMILY SERVICE

Sheet 3

**BASELINE QUANTITIES:**

The above rates are applicable only to residential use. PG&E may require the Customer to submit a completed "Declaration of Eligibility for Baseline Quantities for Residential Rates." The delivered quantities of gas shown below are billed at the rates for baseline use. As an exception, service under this schedule not used to supply space heating but used to supply water heating from a central source to residential dwelling units that are individually metered by PG&E for either gas or electricity will be billed using a baseline quantity of 0.5 therms per dwelling unit per day (Code W) in all baseline territories and in both seasons.

Baseline Territories	BASELINE QUANTITIES (Therms Per Day Per Dwelling Unit)						(T)   (T)
	Summer (April-October)		Winter Off-Peak (Nov, Feb, Mar)		Winter On-Peak (Dec, Jan)		
	Effective Apr. 1, 2020		Effective Nov. 1, 2019		Effective Dec. 1, 2019		
**							
P	0.29	(R)	0.87	(R)	1.00	(I)	
Q	0.49	(R)	0.64	(R)	0.77	(I)	
R	0.33	(R)	0.84	(R)	1.19	(I)	
S	0.29	(R)	0.54	(R)	0.68	(I)	
T	0.49	(R)	0.94	(R)	1.06	(R)	
V	0.56		1.18	(R)	1.29	(I)	
W	0.23	(R)	0.61	(R)	0.87	(R)	
X	0.33	(R)	0.64	(R)	0.77	(I)	
Y	0.36		0.87	(R)	1.00	(I)	

**SEASONAL CHANGES:**

The summer season is April-October, the winter off-peak season is November, February and March, and the winter on-peak season is December and January. Baseline quantities for bills that include the April 1, November 1 and December 1 seasonal changeover dates will be calculated by multiplying the applicable daily baseline quantity for each season by the number of days in each season for the billing period.

**STANDARD MEDICAL QUANTITIES:**

Additional medical quantities (Code M) are available as provided in Rule 19.

**RESIDENTIAL DWELLING UNITS:**

It is the responsibility of the Customer to advise PG&E within 15 days following any change in the number of residential dwelling units, mobile home spaces, and permanent-residence RV units receiving gas service.

**CENTRAL BOILERS:**

Service to central boilers for water and/or space heating will be billed with monthly baseline quantities related to the number of dwelling units furnished such water and/or space heating.



**SCE**

The following pages provide details on are the SCE electricity tariffs applied in this study. Table 16 describes the baseline territories that were assumed for each climate zone.

**Table 16: SCE Baseline Territory by Climate Zone**

	Baseline Territory
CZ06	6
CZ08	8
CZ09	9
CZ10	10
CZ14	14
CZ15	15

Schedule TOU-D  
TIME-OF-USE  
DOMESTIC  
 (Continued)

Sheet 2

RATES

Customers receiving service under this Schedule will be charged the applicable rates under Option 4-9 PM, Option 4-9 PM-CPP, Option 5-8 PM, Option 5-8 PM-CPP, Option PRIME, Option PRIME-CPP Option A, Option A-CPP, Option B, or Option B-CPP, as listed below. CPP Event Charges will apply to all energy usage during CPP Event Energy Charge periods and CPP Non-Event Energy Credits will apply as a reduction on CPP Non-Event Energy Credit Periods during Summer Season weekdays, 4:00 p.m. to 9:00 p.m., as described in Special Conditions 1 and 3, below:

	Delivery Service		
	Total <sup>1</sup>	UG <sup>2</sup>	DWREC <sup>3</sup>
<b>Option 4-9 PM / Option 4-9 PM-CPP</b>			
Energy Charge - \$/kWh			
Summer Season - On-Peak	0.21574 (I)	0.17870 (I)	(0.00007)
Mid-Peak	0.21574 (I)	0.10434 (R)	(0.00007)
Off-Peak	0.17099 (I)	0.07584 (R)	(0.00007)
Winter Season - Mid-Peak	0.21574 (I)	0.12676 (R)	(0.00007)
Off-Peak	0.17099 (I)	0.08874 (R)	(0.00007)
Super-Off-Peak	0.16567 (I)	0.07025 (R)	(0.00007)
Baseline Credit <sup>4</sup> - \$/kWh	(0.07456) (R)	0.00000	
Basic Charge - \$/day			
Single-Family Residence	0.031		
Multi-Family Residence	0.024		
Minimum Charge <sup>2</sup> - \$/day			
Single Family Residence	0.346		
Multi-Family Residence	0.346		
Minimum Charge (Medical Baseline) <sup>3</sup> - \$/day			
Single Family Residence	0.173		
Multi-Family Residence	0.173		
California Climate Credit <sup>4</sup>	(37.00) (I)		
California Alternate Rates for Energy Discount - %	100.00 <sup>*</sup>		
Family Electric Rate Assistance Discount - %	100.00		
<b>Option 4-9 PM-CPP</b>			
CPP Event Energy Charge - \$/kWh		0.80000	
Summer CPP Non-Event Credit			(0.15170)
On-Peak Energy Credit - \$/kWh			(0.15170)
Maximum Available Credit - \$/kWh <sup>4</sup>			(0.58504) (R)
Summer Season			(0.58504) (R)

\* Represents 100% of the discount percentage as shown in the applicable Special Condition of this Schedule.  
<sup>2</sup> The Minimum Charge is applicable when the Delivery Service Energy Charge, plus the applicable Basic Charge is less than the Minimum Charge.  
<sup>3</sup> The ongoing Competition Transition Charge CTC of \$0.00089 per kWh is recovered in the UG component of Generation.  
<sup>4</sup> The Baseline Credit applies up to 100% of the Baseline Allocation, regardless of Time of Use. The Baseline Allocation is set forth in Preliminary Statement, Part H.  
<sup>4</sup> The Maximum Available Credit is the capped credit amount for CPP Customers dual participating in other demand response programs.  
 1 Total - Total Delivery Service rates are applicable to Bundled Service, Direct Access (DA) and Community Choice Aggregation Service (CCA Service) Customers, except DA and CCA Service Customers are not subject to the DWRBC rate component of this Schedule but instead pay the DWRBC as provided by Schedule DA-CRS or Schedule CCA-CRS.  
 2 Generation - The Gen rates are applicable only to Bundled Service Customers.  
 3 DWREC - Department of Water Resources (DWR) Energy Credit - For more information on the DWR Energy Credit, see the Billing Calculation Special Condition of this Schedule.  
 4 Applied on an equal basis, per household, semi-annually. See the Special Conditions of this Schedule for more information.



Schedule TOU-D  
 TIME-OF-USE  
 DOMESTIC  
 (Continued)

SPECIAL CONDITIONS

1. Applicable rate time periods are defined as follows:

Option 4-9 PM, Option 4-9 PM-CPP, Option PRIME, Option PRIME-CPP:

(T)

TOU Period	Weekdays		Weekends and Holidays	
	Summer	Winter	Summer	Winter
On-Peak	4 p.m. - 9 p.m.	N/A	N/A	N/A
Mid-Peak	N/A	4 p.m. - 9 p.m.	4 p.m. - 9 p.m.	4 p.m. - 9 p.m.
Off-Peak	All other hours	9 p.m. - 8 a.m.	All other hours	9 p.m. - 8 a.m.
Super-Off-Peak	N/A	8 a.m. - 4 p.m.	N/A	8 a.m. - 4 p.m.
CPP Event Period	4 p.m. - 9 p.m.	4 p.m. - 9 p.m.	N/A	N/A

Summer Daily Allocations (June through September)

Baseline Region Number	Daily kWh Allocation	All-Electric Allocation
5	17.2	17.9
6	11.4	8.8
8	12.6	9.8
9	16.5	12.4
10	18.9	15.8
13	22.0	24.6
14	18.7	18.3
15	46.4	24.1
16	14.4	13.5



## Winter Daily Allocations (October through May)

Baseline Region Number	Daily kWh Allocation	All-Electric Allocation
5	18.7	29.1
6	11.3	13.0
8	10.6	12.7
9	12.3	14.3
10	12.5	17.0
13	12.6	24.3
14	12.0	21.3
15	9.9	18.2
16	12.6	23.1



**SoCalGas**

Following are the SoCalGas natural gas tariffs applied in this study. Table 17 describes the baseline territories that were assumed for each climate zone.

**Table 17: SoCalGas Baseline Territory by Climate Zone**

	Baseline Territory
CZ05	2
CZ06	1
CZ08	1
CZ09	1
CZ10	1
CZ14	2
CZ15	1

The SoCalGas monthly gas rate in \$/therm was applied on a monthly basis for the 12-month period ending April 2020 according to the rates shown in Table 18. Historical natural gas rate data was only available for SoCalGas' procurement charges<sup>5</sup>. To estimate total costs by month, the baseline and excess transmission charges were assumed to be relatively consistent and applied for the entire year based on April 2020 costs.

**Table 18: SoCalGas Monthly Gas Rate (\$/Therm)**

Month	Procurement Charge	Transmission Charge		Total Charge	
		Baseline	Excess	Baseline	Excess
Jan 2020	\$0.34730	\$0.81742	\$1.17186	\$1.16472	\$1.51916
Feb 2020	\$0.28008	\$0.81742	\$1.17186	\$1.09750	\$1.45194
Mar 2020	\$0.22108	\$0.81742	\$1.17186	\$1.03850	\$1.39294
Apr 2020	\$0.20307	\$0.81742	\$1.17186	\$1.02049	\$1.37493
May 2019	\$0.23790	\$0.81742	\$1.17186	\$1.05532	\$1.40976
June 2019	\$0.24822	\$0.81742	\$1.17186	\$1.06564	\$1.42008
July 2019	\$0.28475	\$0.81742	\$1.17186	\$1.10217	\$1.45661
Aug 2019	\$0.27223	\$0.81742	\$1.17186	\$1.08965	\$1.44409
Sept 2019	\$0.26162	\$0.81742	\$1.17186	\$1.07904	\$1.43348
Oct 2019	\$0.30091	\$0.81742	\$1.17186	\$1.11833	\$1.47277
Nov 2019	\$0.27563	\$0.81742	\$1.17186	\$1.09305	\$1.44749
Dec 2019	\$0.38067	\$0.81742	\$1.17186	\$1.19809	\$1.55253

<sup>5</sup> The SoCalGas procurement and transmission charges were obtained from the following site:

<https://www.socalgas.com/for-your-business/energy-market-services/gas-prices>



SOUTHERN CALIFORNIA GAS COMPANY Revised CAL. P.U.C. SHEET NO. 57458-G  
 LOS ANGELES, CALIFORNIA CANCELING Revised CAL. P.U.C. SHEET NO. 57432-G

Schedule No. GM		Sheet 2	
<u>MULTI-FAMILY SERVICE</u>			
<u>(Includes GM-E, GM-C, GM-EC, GM-CC, GT-ME, GT-MC and all GMB Rates)</u>			
(Continued)			
<b><u>APPLICABILITY</u></b> (Continued)			
Multi-family Accommodations built prior to December 15, 1981 and currently served under this schedule may also be eligible for service under Schedule No. GS. If an eligible Multi-family Accommodation served under this schedule converts to an applicable submetered tariff, the tenant rental charges shall be revised for the duration of the lease to reflect removal of the energy related charges.			
Eligibility for service hereunder is subject to verification by the Utility.			
<b><u>TERRITORY</u></b>			
Applicable throughout the service territory.			
<b><u>RATES</u></b>			
<u>Customer Charge</u> , per meter, per day: .....	<u>GM/GT-M</u> 16.438¢	<u>GMB/GT-MB</u> \$16.357	
For "Space Heating Only" customers, a daily Customer Charge applies during the winter period from November 1 through April 30 <sup>1/</sup> : .....			
	33.149¢		
<b><u>GM</u></b>			
<u>Baseline Rate</u> , per therm (baseline usage defined per Special Conditions 3 and 4):	<u>GM-E</u>	<u>GM-EC</u> <sup>1/</sup>	<u>GT-ME</u>
Procurement Charge: <sup>2/</sup> .....	20.307¢	20.307¢	N/A
Transmission Charge: .....	81.742¢	81.742¢	81.742¢
Total Baseline Charge (all usage): .....	102.049¢	102.049¢	81.742¢
<u>Non-Baseline Rate</u> , per therm (usage in excess of baseline usage):			
Procurement Charge: <sup>2/</sup> .....	20.307¢	20.307¢	N/A
Transmission Charge: .....	117.186¢	117.186¢	117.186¢
Total Non Baseline Charge (all usage): .....	137.493¢	137.493¢	117.186¢
<u>Non-Baseline Rate</u> , per therm (usage in excess of baseline usage):	<u>GM-C</u>	<u>GM-CC</u> <sup>3/</sup>	<u>GT-MC</u>
Procurement Charge: <sup>2/</sup> .....	20.307¢	20.307¢	N/A
Transmission Charge: .....	117.186¢	117.186¢	117.186¢
Total Non Baseline Charge (all usage): .....	137.493¢	137.493¢	117.186¢
<sup>1/</sup> For the summer period beginning May 1 through October 31, with some exceptions, usage will be accumulated to at least 20 Ccf (100 cubic feet) before billing, or it will be included with the first bill of the heating season which may cover the entire duration since a last bill was generated for the current calendar year. (Footnotes continue next page.)			

(Continued)

(TO BE INSERTED BY UTILITY)  
 ADVICE LETTER NO. 5614  
 DECISION NO.

ISSUED BY  
**Dan Skopec**  
 Vice President  
 Regulatory Affairs

(TO BE INSERTED BY CAL. PUC)  
 SUBMITTED Apr 6, 2020  
 EFFECTIVE Apr 10, 2020  
 RESOLUTION NO. G-3351

207



SOUTHERN CALIFORNIA GAS COMPANY Revised CAL. P.U.C. SHEET NO. 57168-G  
 LOS ANGELES, CALIFORNIA CANCELING Revised CAL. P.U.C. SHEET NO. 41015-G

Schedule No. GM Sheet 5  
MULTI-FAMILY SERVICE  
 (Includes GM-E, GM-C, GM-EC, GM-CC, GT-ME, GT-MC and all GMB Rates)  
 (Continued)

SPECIAL CONDITIONS (Continued)

3. (Continued)

Codes	Per Residence	Daily Therm Allowance for Climate Zones*		
		1	2	3
1	Space heating only			
	Summer	0.000	0.000	0.000
	Winter	1.210	1.343	2.470
2	Water heating and cooking	0.477	0.477	0.477
3	Cooking, water heating and space heating			
	Summer	0.473	0.473	0.473
	Winter	1.691	1.823	2.950
4	Cooking and space heating			
	Summer	0.088	0.088	0.088
	Winter	1.299	1.432	2.559
5	Cooking only	0.089	0.089	0.089
6	Water heating only	0.388	0.388	0.388
7	Water heating and space heating			
	Summer	0.385	0.385	0.385
	Winter	1.601	1.734	2.861

\* Climate Zones are described in the Preliminary Statement.

4. Medical Baseline: Upon completion of an application and verification by a state-licensed physician, nurse practitioner, physician's assistant, or osteopath (Form No. 4859-E), an additional Baseline allowance of 0.822 therms per day will be provided for paraplegic, quadriplegic, or hemiplegic persons, those afflicted with multiple sclerosis or scleroderma, or persons being treated for a life threatening illness or who have a compromised immune system.

Where it is established that the energy required for a Life-Support Device, as defined in Rule No. 1, exceeds 0.822 therms per day, an additional uniform daily Baseline allowance will be provided. The amount of the additional allowance will be determined by the Utility from load and operating time data of the Life-Support Device.

5. Space Heating Only: Applies to customers who are using gas primarily for space heating, as determined by survey or under the presumption that customers who use less than 11 Ccf per month during each of the regular billing periods ending in August and September qualify for Heat Only billing.

(Continued)

(TO BE INSERTED BY UTILITY)  
 ADVICE LETTER NO. 5576-A  
 DECISION NO. 02-04-026

ISSUED BY  
**Dan Skopec**  
 Vice President

(TO BE INSERTED BY CAL. PUC)  
 SUBMITTED Jan 31, 2020  
 EFFECTIVE Feb 27, 2020

T  
N



**SDG&E**

Following are the SDG&E electricity and natural gas tariffs applied in this study. Table 19 describes the baseline territories that were assumed for each climate zone. All-Electric baseline allowances were applied.

**Table 19: SDG&E Baseline Territory by Climate Zone**

	Baseline Territory
CZ07	Coastal
CZ10	Inland
CZ14	Mountain



Revised Cal. P.U.C. Sheet No. 33144-E

Canceling Revised Cal. P.U.C. Sheet No. 32930-E

<b>SCHEDULE TOU-DR1</b>						Sheet 2
<u>RESIDENTIAL TIME-OF-USE</u>						
<b>RATES</b>						
<b>Total Rates:</b>						
Description – TOU DR1	UDC Total Rate	DWR-BC Rate	EECC Rate + DWR Credit		Total Rate	
<b>Summer:</b>						
On-Peak	0.22374	I 0.00580	0.29042	R	0.51996	R
Off-Peak	0.22374	I 0.00580	0.09305	R	0.32259	R
Super Off-Peak	0.22374	I 0.00580	0.04743	R	0.27697	R
<b>Winter:</b>						
On-Peak	0.25734	R 0.00580	0.07844	R	0.34158	R
Off-Peak	0.25734	R 0.00580	0.06961	R	0.33275	R
Super Off-Peak	0.25734	R 0.00580	0.05981	R	0.32295	R
Summer Baseline Adjustment Credit up to 130% of Baseline	(0.07506)	I			(0.07506)	I
Winter Baseline Adjustment Credit up to 130% of Baseline	(0.06833)	I			(0.06833)	I
Minimum Bill (\$/day)	0.338				0.338	
<b>Note:</b>						
(1) Total Rates consist of UDC, Schedule DWR-BC (Department of Water Resources Bond Charge), and Schedule EECC (Electric Energy Commodity Cost) rates, with the EECC rates reflecting a DWR Credit.						
(2) Total Rates presented are for customers that receive commodity supply and delivery service from Utility.						
(3) DWR-BC charges do not apply to CARE customers.						
(4) As identified in the rates tables, customer bills will also include line-item summer and winter credits for usage up to 130% of baseline to provide the rate capping benefits adopted by Assembly Bill 1X and Senate Bill 695.						
(Continued)						

2C8

Advice Ltr. No. 3514-E

Decision No. D.20-01-021

Issued by  
**Dan Skopec**  
Vice President  
Regulatory Affairs

Submitted Mar 26, 2020

Effective Apr 1, 2020

Resolution No. \_\_\_\_\_





Time Periods

All time periods listed are applicable to local time. The definition of time will be based upon the date service is rendered.

TOU Periods – Weekdays	Summer	Winter
On-Peak	4:00 p.m. – 9:00 p.m.	4:00 p.m. – 9:00 p.m.
Off-Peak	6:00 a.m. – 4:00 p.m.; 9:00 p.m. - midnight	6:00 a.m. – 4:00 p.m. Excluding 10:00 a.m. – 2:00 p.m. in March and April; 9:00 p.m. - midnight
Super Off-Peak	Midnight – 6:00 a.m.	Midnight – 6:00 a.m. 10:00 a.m. – 2:00 p.m. in March and April
TOU Period – Weekends and Holidays	Summer	Winter
On-Peak	4:00 p.m. – 9:00 p.m.	4:00 p.m. – 9:00 p.m.
Off-Peak	2:00 p.m. – 4:00 p.m.; 9:00 p.m. - midnight	2:00 p.m. – 4:00 p.m.; 9:00 p.m. - midnight
Super Off-Peak	Midnight – 2:00 p.m.	Midnight – 2:00 p.m.

Seasons:        Summer        June 1 – October 31  
                   Winter         November 1 – May 31

Baseline Usage: The following quantities of electricity are used to calculate the baseline adjustment credit.

	Baseline Allowance For Climatic Zones*			
	Coastal	Inland	Mountain	Desert
<b>Basic Allowance</b>				
Summer (June 1 to October 31)	9.0	10.4	13.6	15.9
Winter (November 1 to May 31)	9.2	9.6	12.9	10.9
<b>All Electric**</b>				
Summer (June 1 to October 31)	6.8	9.2	15.6	17.5
Winter (November 1 to May 31)	10.4	13.4	23.4	18.1

\* Climatic Zones are shown on the Territory Served, Map No. 1.

\*\* All Electric allowances are available upon application to those customers who have permanently installed space heating or who have electric water heating and receive no energy from another source.





San Diego Gas & Electric Company  
San Diego, California

Revised Cal. P.U.C. Sheet No. 24487-G

Canceling Revised Cal. P.U.C. Sheet No. 24422-G

<b>SCHEDULE GM</b>				Sheet 2
<b>MULTI-FAMILY NATURAL GAS SERVICE</b>				
<i>(Includes Rates for GM, GM-C and GTC/GTCA)</i>				
<u>RATES</u>				
	GM		GM-C	GTC/GTCA <sup>1</sup>
<u>Baseline Rate, per therm (baseline usage defined in Special Condition 4)</u>				
Procurement Charge <sup>2</sup> .....	\$0.20327	R	\$0.22130	N/A
Transmission Charge.....	<u>\$1.35946</u>		<u>\$1.35946</u>	<u>\$1.37374</u>
Total Baseline Charge.....	\$1.56273	R	\$1.58076	\$1.37374
<u>Non-Baseline Rate (usage in excess of baseline usage)</u>				
Procurement Charge <sup>2</sup> .....	\$0.20327	R	\$0.22130	N/A
Transmission Charge.....	<u>\$1.59125</u>		<u>\$1.59125</u>	<u>\$1.60553</u>
Total Non-Baseline Charge.....	\$1.79452	R	\$1.81255	\$1.60553
<u>Minimum Bill, per day<sup>3</sup></u>				
Non-CARE customers.....	\$0.09863		\$0.09863	\$0.09863
CARE customers.....	\$0.07890		\$0.07890	\$0.07890

(Continued)

2C6

Advice Ltr. No. 2858-G

Decision No. \_\_\_\_\_

Issued by

**Dan Skopec**

Vice President  
Regulatory Affairs

Submitted

Mar 31, 2020

Effective

Apr 1, 2020

Resolution No. \_\_\_\_\_

Baseline Usage. The following quantities of gas are to be billed at the baseline rate for multi-family units. Usage in excess of applicable baseline usage will be billed at non-baseline rates.

	<u>Daily Therm Allowance Per Residential Unit</u>
Summer (May 1 to October 31, inclusive)	0.345
Winter (November 1 to April 30, inclusive)	1.082



The SDG&E monthly gas rate in \$/therm was applied on a monthly basis for the 12-month period ending April 2020 according to the rates shown in Table 20. Historical natural gas rate data was only available for SoCalGas' procurement charges<sup>6</sup>. To estimate total costs by month, the baseline and excess transmission charges were assumed to be relatively consistent and applied for the entire year based on April 2020 costs.

**Table 20: SDG&E Monthly Gas Rate (\$/Therm)**

Month	Procurement Charge	Transmission Charge		Total Charge	
		Baseline	Excess	Baseline	Excess
Jan 2020	\$0.34761	\$1.36166	\$1.59166	\$1.70927	\$1.93927
Feb 2020	\$0.28035	\$1.36166	\$1.59166	\$1.64201	\$1.87201
Mar 2020	\$0.22130	\$1.36166	\$1.59166	\$1.58296	\$1.81296
Apr 2020	\$0.20327	\$1.35946	\$1.59125	\$1.56273	\$1.79452
May 2019	\$0.23804	\$1.06349	\$1.25253	\$1.30153	\$1.49057
June 2019	\$0.24838	\$1.06349	\$1.25253	\$1.31187	\$1.50091
July 2019	\$0.28491	\$1.06349	\$1.25253	\$1.34840	\$1.53744
Aug 2019	\$0.27239	\$1.06349	\$1.25253	\$1.33588	\$1.52492
Sept 2019	\$0.26178	\$1.06349	\$1.25253	\$1.32527	\$1.51431
Oct 2019	\$0.30109	\$1.06349	\$1.25253	\$1.36458	\$1.55362
Nov 2019	\$0.27580	\$1.06349	\$1.25253	\$1.33929	\$1.52833
Dec 2019	\$0.38090	\$1.06349	\$1.25253	\$1.44439	\$1.63343

<sup>6</sup> The SDG&E procurement and transmission charges were obtained from the following sets of documents:  
[http://regarchive.sdge.com/tm2/pdf/GAS\\_GAS-SCHEDS\\_GM\\_2020.pdf](http://regarchive.sdge.com/tm2/pdf/GAS_GAS-SCHEDS_GM_2020.pdf)  
[http://regarchive.sdge.com/tm2/pdf/GAS\\_GAS-SCHEDS\\_GM\\_2019.pdf](http://regarchive.sdge.com/tm2/pdf/GAS_GAS-SCHEDS_GM_2019.pdf)



**SMUD**

Following are the SMUD electricity tariffs applied in this study.

## RTOD Rate Schedule

**II. Firm Service Rates**

<b>A. Time-of-Day (5-8 p.m.) Rate</b>	<b>Rate Category RT02</b>
<b>Non-Summer Prices* – January 1 through May 31</b>	
System Infrastructure Fixed Charge per month	\$21.05
Electricity Usage Charge	
Peak \$/kWh	\$0.1388
Off-Peak \$/kWh	\$0.1006
<b>Summer Prices - June 1 through September 30</b>	
System Infrastructure Fixed Charge per month	\$21.05
Electricity Usage Charge	
Peak \$/kWh	\$0.2941
Mid-Peak \$/kWh	\$0.1671
Off-Peak \$/kWh	\$0.1209
<b>Non-Summer Prices* – October 1 through December 31</b>	
System Infrastructure Fixed Charge per month	\$21.70
Electricity Usage Charge	
Peak \$/kWh	\$0.1430
Off-Peak \$/kWh	\$0.1035

\* Non-Summer Season includes Fall (Oct 1 – Nov 30), Winter (Dec 1 – Mar 31) and Spring (Apr 1 – May 31) periods.

<b>Summer (Jun 1 - Sept 30)</b>	<b>Peak</b>	Weekdays between 5:00 p.m. and 8:00 p.m.
	<b>Mid-Peak</b>	Weekdays between noon and midnight except during the Peak hours.
	<b>Off-Peak</b>	All other hours, including weekends and holidays <sup>1</sup> .
<b>Non-Summer (Oct 1 - May 31)</b>	<b>Peak</b>	Weekdays between 5:00 p.m. and 8:00 p.m.
	<b>Off-Peak</b>	All other hours, including weekends and holidays <sup>1</sup> .



GSN\_T Rate Schedule:

**II. Firm Service Rates**

Rate Category	Nondemand GSN_T	Flat GFN	Demand GSS_T
<b>Winter Season – January 1 through May 31</b>			
System Infrastructure Fixed Charge - per month per meter	\$21.15	\$9.45	\$25.75
Site Infrastructure Charge (per 12 months max kW or contract capacity)	n/a	n/a	\$7.94
<b>Electricity Usage Charge</b>			
All day \$/kWh	\$0.1365	\$0.1381	\$0.1071
<b>Summer Season - June 1 through September 30</b>			
System Infrastructure Fixed Charge - per month per meter	\$21.15	\$9.45	\$25.75
Site Infrastructure Charge (per 12 months max kW or contract capacity)	n/a	n/a	\$7.94
<b>Electricity Usage Charge</b>			
On-peak \$/kWh	\$0.3151	\$0.1381	\$0.2733
Off-peak \$/kWh	\$0.1152	\$0.1381	\$0.0948

Rate Category	Nondemand GSN_T	Flat GFN	Demand GSS_T
<b>Winter Season - October 1 through December 31</b>			
System Infrastructure Fixed Charge - per month per meter	\$21.80	\$9.70	\$26.50
Site Infrastructure Charge (per 12 months max kW or contract capacity)	n/a	n/a	\$8.18
<b>Electricity Usage Charge</b>			
All day \$/kWh	\$0.1406	\$0.1423	\$0.1103

**D. Billing Periods**

1. Winter (October 1 – May 31) All hours are off-peak.

2. Summer Time-of-Use Billing Periods (June 1 – September 30)

<b>On-Peak</b>	Summer weekdays between 3:00 p.m. and 6:00 p.m.
<b>Off-Peak</b>	All other hours, including holidays shown below



**CPAU**

Following are the CPAU electricity and natural gas tariffs applied in this study.

**E1 Rate Schedule:**

**RESIDENTIAL ELECTRIC SERVICE**

UTILITY RATE SCHEDULE E-1

**A. APPLICABILITY:**

This Rate Schedule applies to separately metered single-family residential dwellings receiving Electric Service from the City of Palo Alto Utilities.

**B. TERRITORY:**

This rate schedule applies everywhere the City of Palo Alto provides Electric Service.

**C. UNBUNDLED RATES:**

<u>Per kilowatt-hour (kWh)</u>	<u>Commodity</u>	<u>Distribution</u>	<u>Public Benefits</u>	<u>Total</u>
Tier 1 usage	\$0.08339	\$0.04971	\$0.00447	\$0.13757
Tier 2 usage Any usage over Tier 1	0.11569	0.07351	0.00447	0.19367
<u>Minimum Bill (\$/day)</u>				0.3283

**E2 Rate Schedule:**

**RESIDENTIAL MASTER-METERED AND SMALL NON-RESIDENTIAL ELECTRIC SERVICE**

UTILITY RATE SCHEDULE E-2

**A. APPLICABILITY:**

This Rate Schedule applies to the following Customers receiving Electric Service from the City of Palo Alto Utilities:

1. Small non-residential Customers receiving Non-Demand Metered Electric Service; and
2. Customers with Accounts at Master-Metered multi-family facilities.

**B. TERRITORY:**

This rate schedule applies everywhere the City of Palo Alto provides Electric Service.

**C. UNBUNDLED RATES:**

<u>Per kilowatt-hour (kWh)</u>	<u>Commodity</u>	<u>Distribution</u>	<u>Public Benefits</u>	<u>Total</u>
Summer Period	\$0.11855	\$0.08551	\$0.00447	\$0.20853
Winter Period	0.08502	0.05675	0.00447	0.14624
<u>Minimum Bill (\$/day)</u>				0.8359



G-2 Rate Schedule:

**RESIDENTIAL MASTER-METERED AND COMMERCIAL GAS SERVICE**

UTILITY RATE SCHEDULE G-2

**A. APPLICABILITY:**

This schedule applies to the following Customers receiving Gas Service from the City of Palo Alto Utilities:

1. Commercial Customers who use less than 250,000 therms per year at one site.
2. Master-metered residential Customers in multi-family residential facilities.

**B. TERRITORY:**

This schedule applies anywhere the City of Palo Alto provides Gas Service.

**C. UNBUNDLED RATES:**

Per Service

Monthly Service Charge: .....\$104.95

Per Therm

Supply Charges:

1. Commodity (Monthly Market Based) ..... \$0.10-\$2.00
2. Cap and Trade Compliance Charges ..... \$0.00-0.25
3. Transportation Charge.....\$0.00-\$0.15
4. Carbon Offset Charge .....\$0.00-\$0.10

Distribution Charge: ..... \$0.6102

G2 Monthly Per Therm Rates:

Effective Date	Commodity Rate	Cap and Trade Compliance Charge	Transportation Charge	Carbon Offset Charge	G2 Total Volumetric Rate
1/1/20	\$0.3289	0.033	0.09941	0.040	1.11151
2/1/20	0.2466	0.033	0.09941	0.040	1.02921
3/1/20	0.2416	0.033	0.09891	0.040	1.02371
4/1/20	0.2066	0.033	0.09891	0.040	0.98871
5/1/20	0.2258	0.033	0.09891	0.040	1.00791
6/1/20	0.2279	0.033	0.09891	0.040	1.01001
7/1/19	0.2471	0.033	0.11757	0.040	1.04787
8/1/19	0.2507	0.033	0.10066	0.040	1.03456
9/1/19	0.2461	0.033	0.10066	0.040	1.02996
10/1/19	0.2811	0.033	0.10288	0.040	1.06718
11/1/19	0.2923	0.033	0.10288	0.040	1.07838
12/1/19	0.3781	0.033	0.10288	0.040	1.16418



### **Escalation Assumptions**

The average annual escalation rates in the following table were used in this study and are from E3's 2019 study Residential Building Electrification in California (Energy & Environmental Economics, 2019). These rates are applied to the 2019 rate schedules over a 30-year period beginning in 2020. SDG&E was not covered in the E3 study. The Statewide Reach Code Team reviewed SDG&E's GRC filing and applied the same approach that E3 applied for PG&E and SoCalGas to arrive at average escalation rates between 2020 and 2022. The statewide electricity escalation rates were also applied to the analysis for SMUD and CPAU. PG&E gas escalation rates were applied to CPAU as the best available estimate since CPAU uses PG&E gas infrastructure.

**Table 21: Real Utility Rate Escalation Rate Assumptions**

	Statewide Electric Residential Average Rate (%/year, real)	Natural Gas Residential Core Rate (%/yr escalation, real)		
		PG&E	SoCalGas	SDG&E
2020	2.0%	1.48%	6.37%	5.00%
2021	2.0%	5.69%	4.12%	3.14%
2022	2.0%	1.11%	4.12%	2.94%
2023	2.0%	4.0%	4.0%	4.0%
2024	2.0%	4.0%	4.0%	4.0%
2025	2.0%	4.0%	4.0%	4.0%
2026	1.0%	1.0%	1.0%	1.0%
2027	1.0%	1.0%	1.0%	1.0%
2028	1.0%	1.0%	1.0%	1.0%
2029	1.0%	1.0%	1.0%	1.0%
2030	1.0%	1.0%	1.0%	1.0%
2031	1.0%	1.0%	1.0%	1.0%
2032	1.0%	1.0%	1.0%	1.0%
2033	1.0%	1.0%	1.0%	1.0%
2034	1.0%	1.0%	1.0%	1.0%
2035	1.0%	1.0%	1.0%	1.0%
2036	1.0%	1.0%	1.0%	1.0%
2037	1.0%	1.0%	1.0%	1.0%
2038	1.0%	1.0%	1.0%	1.0%
2039	1.0%	1.0%	1.0%	1.0%
2040	1.0%	1.0%	1.0%	1.0%
2041	1.0%	1.0%	1.0%	1.0%
2042	1.0%	1.0%	1.0%	1.0%
2043	1.0%	1.0%	1.0%	1.0%
2044	1.0%	1.0%	1.0%	1.0%
2045	1.0%	1.0%	1.0%	1.0%
2046	1.0%	1.0%	1.0%	1.0%
2047	1.0%	1.0%	1.0%	1.0%
2048	1.0%	1.0%	1.0%	1.0%
2049	1.0%	1.0%	1.0%	1.0%





## Appendix C – PG&E Gas Infrastructure Cost Memo



Janice Berman  
Director – Grid Edge  
Pacific Gas and Electric Company  
Mail Code B9F  
P.O. Box 770000  
San Francisco, CA 94177-0001

December 5, 2019

Energy Commission Staff:

On March 2, 2018, PG&E provided gas extension cost estimates for residential existing and new subdivisions (see attached memo). We have recently updated our estimates and are therefore providing an updated memo.

In addition to mainline and service extension costs, we are also providing estimates of the cost of gas meters for different building types including both residential and commercial customers. These estimates are based on PG&E historical jobs.

Developing gas extension cost estimates is complex and the actual costs are project dependent. Costs vary widely with location, terrain, distance to the nearest main, joint trenching, materials, number of dwellings per development, and several other site and job-specific conditions. For these reasons, it is not practical to come up with estimates that represent every case. Instead we are including estimates based on historical averages taken from projects within PG&E's territory. It is not recommended to compare specific project costs to these estimates as any number of factors could lead to higher or lower costs than these averages are representing.

We are also including estimates for in-house gas infrastructure costs and specific plan review costs. These estimates are from external sources, and are not based on PG&E data, but have been provided for the sake of completeness and for use in energy efficiency analysis.

To further anchor the estimates, several assumptions have been made:

1. It is assumed that during new construction, gas infrastructure will likely be joint trenched with electric infrastructure. As a result, the incremental cost of trenching associated with the gas infrastructure alone is minimal. Therefore, all mainline cost estimates exclude trench costs. Service extension cost estimates include both estimates with and without trench costs. In the case where new construction would require overhead electric and underground gas infrastructure, the estimates with trench costs included for service extensions should be utilized.
2. It is assumed that new construction in an existing subdivision would not generally require a mainline extension. In cases where a mainline extension would be required to an existing subdivision, the costs are highly dependent on the location, terrain, and distance to the nearest main.





Janice Berman  
Director – Grid Edge  
Pacific Gas and Electric Company  
Mail Code B9F  
P.O. Box 770000  
San Francisco, CA 94177-0001

3. These estimates are for total costs. The cost estimates have not been reduced to account for the portion of the costs paid by all customers due to application of Rule 15<sup>1</sup> and Rule 16<sup>2</sup> allowances. Hence, costs to the specific customer may be lower than the estimates below, as the specific customer benefits from the Rule 15 and Rule 16 allowances.

Table 1: PG&E Gas Infrastructure Cost Estimates

	Existing Subdivision/Development	New Greenfield Subdivision/Development
Mainline Extension	N/A <sup>3</sup>	<u>Single-Family</u> \$17/ft <sup>4</sup>  <u>Multi-Family</u> \$11/ft <sup>4</sup>
Service Extension (Typically 1" pipe from mainline to the meter)	\$6750 per service/building <sup>4</sup> (excludes trench costs)  \$9200 per service/building <sup>4</sup> (includes trench costs)	\$1300 per service/building <sup>4</sup> (includes mainline extension costs within the subdivision; excludes trench costs)  \$1850 per service/building <sup>4</sup> (includes mainline extension costs within the subdivision; includes trench costs)
Meter	<u>Residential Single Family</u> \$300 per meter <sup>5</sup>  <u>Residential Multi-Family</u> \$300 per meter + \$300 per meter manifold outlet <sup>5</sup>  <u>Small/Medium Commercial</u> \$3600 per meter <sup>6</sup>	<u>Residential Single Family</u> \$300 per meter <sup>5</sup>  <u>Residential Multi-Family</u> \$300 per meter + \$300 per meter manifold outlet <sup>5</sup>  <u>Small/Medium Commercial</u> \$3600 per meter <sup>6</sup>

<sup>1</sup> [https://www.pge.com/tariffs/tm2/pdf/ELEC\\_RULES\\_15.pdf](https://www.pge.com/tariffs/tm2/pdf/ELEC_RULES_15.pdf)

<sup>2</sup> [https://www.pge.com/tariffs/tm2/pdf/ELEC\\_RULES\\_16.pdf](https://www.pge.com/tariffs/tm2/pdf/ELEC_RULES_16.pdf)

<sup>3</sup> It is assumed that new construction in an existing subdivision would not require a main extension.

<sup>4</sup> Estimates based on PG&E jobs from Jan 2016 - Dec 2017 from PG&E's Service Planning team.

<sup>5</sup> Estimates from PG&E's Dedicated Estimating Team. For Multi-Family units, the costs of \$300 per meter and \$300 per meter manifold outlet should be combined for a total of \$600 per meter.

<sup>6</sup> PG&E Marginal Customer Access Cost Estimates presented in the 2018 Gas Cost Allocation Proceedings (GCAP), A.17-09-006, Exhibit PG&E-2, Appendix A, Section A, Table A-1. The Average Connection Cost per Customer values were included in the MCAC workpaper that accompanied the GCAP testimony





Janice Berman  
Director – Grid Edge  
Pacific Gas and Electric Company  
Mail Code B9F  
P.O. Box 770000  
San Francisco, CA 94177-0001

	<u>Large Commercial</u> \$32,000 per meter <sup>6</sup>	<u>Large Commercial</u> \$32,000 per meter <sup>6</sup>
--	--	--

Note: Service extension cost estimates for New Greenfield Subdivisions include mainline extension costs as well. Therefore, mainline cost estimates can be ignored for the purpose of estimating total project costs.

Table 2: Gas Infrastructure Cost Estimates from Other Sources

	Existing Subdivision/Development	New Greenfield Subdivision/Development
In-House Infrastructure	<u>Single-Family</u> \$800 <sup>7</sup>	<u>Single-Family</u> \$800 <sup>7</sup>
	<u>Multi-Family</u> \$600 per unit <sup>7</sup>	<u>Multi-Family</u> \$600 per unit <sup>7</sup>
	<u>Medium Office</u> \$600-4500 <sup>7,8</sup>	<u>Medium Office</u> \$600-4500 <sup>7,8</sup>
	<u>Medium Retail</u> \$10,000 <sup>8</sup>	<u>Medium Retail</u> \$10,000 <sup>8</sup>
Plan Review (Will vary by city and often not a fixed fee)	<u>Residential</u> Palo Alto - \$850 <sup>9</sup>	<u>Residential</u> Palo Alto - \$850 <sup>9</sup>
	<u>Nonresidential</u> Palo Alto - \$2316 <sup>9</sup>	<u>Nonresidential</u> Palo Alto - \$2316 <sup>9</sup>

Please let us know if there are any follow-up questions or clarifications.

Best regards,

<sup>7</sup> Frontier Energy, Inc., Misti Bruceri & Associates, LLC. 2019. "2019 Cost-effectiveness Study: Low Rise Residential New Construction." Available at: <https://localenergycodes.com/content/performance-ordinances>

<sup>8</sup> TRC, EnergySoft. 2019. "2019 Nonresidential New Construction Reach Code Cost Effectiveness Study." Available at: <https://localenergycodes.com/content/performance-ordinances>

<sup>9</sup> TRC. 2018. "City of Palo Alto 2019 Title 24 Energy Reach Code Cost Effectiveness Analysis Draft." Available at: <http://cityofpaloalto.org/civicax/filebank/documents/66742>



## Appendix D – Detailed Results Mixed-Fuel

**Table 22: Mixed-Fuel Efficiency Only Package Results (SAVINGS/COST PER APARTMENT)<sup>1</sup>**

Climate Zone	Elec Utility	Gas Utility	Apartments			Central Water Heating			Total	Savings (2020 PV\$)			B/C Ratio <sup>1</sup>	
			Gas Savings (therms)	Elec Savings (kWh)	Year 1 Utility Cost Savings	Gas Savings (therms)	Elec Savings (kWh)	Year 1 Utility Cost Savings	Year 1 Utility Cost Savings	On-Bill Utility Cost Savings	TDV Cost Savings	Total Inc. Cost (\$)	On-Bill	TDV
CZ01	PGE	PGE	0.0	26	\$6	0.0	0	\$0	\$6	\$133	\$105	\$304	0.44	0.35
CZ02	PGE	PGE	0.0	47	\$17	0.0	0	\$0	\$17	\$391	\$285	\$144	2.72	1.98
CZ03	PGE	PGE	0.0	44	\$15	0.0	0	\$0	\$15	\$345	\$226	\$144	2.40	1.57
CZ04	PGE	PGE	0.0	61	\$20	0.0	0	\$0	\$20	\$465	\$331	\$144	3.24	2.31
CZ04-2	CPAU	CPAU	0.0	61	\$10	0.0	0	\$0	\$10	\$248	\$331	\$144	1.73	2.31
CZ05	PGE	PGE	0.0	42	\$14	0.0	0	\$0	\$14	\$320	\$206	\$144	2.22	1.43
CZ05-2	PGE	SCG	0.0	42	\$14	0.0	0	\$0	\$14	\$320	\$206	\$144	2.22	1.43
CZ06	SCE	SCG	0.0	74	\$18	0.0	0	\$0	\$18	\$424	\$351	\$144	2.95	2.44
CZ07	SDGE	SDGE	0.0	81	\$25	0.0	0	\$0	\$25	\$593	\$374	\$144	4.13	2.60
CZ08	SCE	SCG	0.0	84	\$20	0.0	0	\$0	\$20	\$484	\$420	\$144	3.37	2.92
CZ09	SCE	SCG	0.0	83	\$20	0.0	0	\$0	\$20	\$468	\$441	\$144	3.26	3.06
CZ10	SCE	SCG	0.0	82	\$17	0.0	0	\$0	\$17	\$410	\$427	\$144	2.85	2.97
CZ10-2	SDGE	SDGE	0.0	82	\$25	0.0	0	\$0	\$25	\$599	\$427	\$144	4.16	2.97
CZ11	PGE	PGE	0.0	104	\$27	0.0	0	\$0	\$27	\$637	\$635	\$625	1.02	1.02
CZ12	PGE	PGE	0.0	93	\$24	0.0	0	\$0	\$24	\$572	\$568	\$304	1.88	1.87
CZ12-2	SMUD	PGE	0.0	93	\$13	0.0	0	\$0	\$13	\$319	\$568	\$304	1.05	1.87
CZ13	PGE	PGE	0.0	132	\$34	0.0	0	\$0	\$34	\$798	\$779	\$625	1.28	1.25
CZ14	SCE	SCG	0.0	80	\$17	0.0	0	\$0	\$17	\$407	\$449	\$304	1.34	1.48
CZ14-2	SDGE	SDGE	0.0	80	\$24	0.0	0	\$0	\$24	\$576	\$449	\$304	1.90	1.48
CZ15	SCE	SCG	0.0	145	\$30	0.0	0	\$0	\$30	\$719	\$802	\$625	1.15	1.28
CZ16	PGE	PGE	0.0	117	\$27	0.0	0	\$0	\$27	\$646	\$563	\$625	1.03	0.90

<sup>1</sup> Values in red indicate B/C ratios less than 1.



**Table 23: Mixed-Fuel Efficiency + PV Package Results (SAVINGS/COST PER APARTMENT)<sup>1</sup>**

Climate Zone	Elec Utility	Gas Utility	0.1 kW <sub>DC</sub> per Apartment					0.2 kW <sub>DC</sub> per Apartment				
			On-Bill Utility Cost Savings (2020 PV\$)	TDV Cost Savings (2020 PV\$)	Total Inc. Cost	On-Bill B/C Ratio	TDV B/C Ratio	On-Bill Utility Cost Savings (2020 PV\$)	TDV Cost Savings (2020 PV\$)	Total Inc. Cost	On-Bill B/C Ratio	TDV B/C Ratio
<b>CZ01</b>	PGE	PGE	\$885	\$597	\$620	1.43	0.96	\$1,637	\$1,090	\$937	1.75	1.16
<b>CZ02</b>	PGE	PGE	\$1,411	\$877	\$460	3.07	1.91	\$2,431	\$1,469	\$777	3.13	1.89
<b>CZ03</b>	PGE	PGE	\$1,373	\$812	\$460	2.98	1.76	\$2,400	\$1,397	\$777	3.09	1.80
<b>CZ04</b>	PGE	PGE	\$1,522	\$947	\$460	3.31	2.06	\$2,579	\$1,562	\$777	3.32	2.01
<b>CZ04-2</b>	CPAU	CPAU	\$807	\$947	\$460	1.75	2.06	\$1,335	\$1,562	\$777	1.72	2.01
<b>CZ05</b>	PGE	PGE	\$1,400	\$834	\$460	3.04	1.81	\$2,480	\$1,461	\$777	3.19	1.88
<b>CZ05-2</b>	PGE	SCG	\$1,400	\$834	\$460	3.04	1.81	\$2,480	\$1,461	\$777	3.19	1.88
<b>CZ06</b>	SCE	SCG	\$1,206	\$969	\$460	2.62	2.11	\$1,987	\$1,587	\$777	2.56	2.04
<b>CZ07</b>	SDGE	SDGE	\$1,701	\$1,010	\$460	3.69	2.19	\$2,770	\$1,647	\$777	3.57	2.12
<b>CZ08</b>	SCE	SCG	\$1,272	\$1,064	\$460	2.76	2.31	\$2,059	\$1,708	\$777	2.65	2.20
<b>CZ09</b>	SCE	SCG	\$1,181	\$1,091	\$460	2.57	2.37	\$1,876	\$1,742	\$777	2.41	2.24
<b>CZ10</b>	SCE	SCG	\$1,104	\$1,054	\$460	2.40	2.29	\$1,797	\$1,681	\$777	2.31	2.16
<b>CZ10-2</b>	SDGE	SDGE	\$1,622	\$1,054	\$460	3.52	2.29	\$2,646	\$1,681	\$777	3.41	2.16
<b>CZ11</b>	PGE	PGE	\$1,537	\$1,256	\$942	1.63	1.33	\$2,438	\$1,877	\$1,258	1.94	1.49
<b>CZ12</b>	PGE	PGE	\$1,462	\$1,181	\$620	2.36	1.90	\$2,352	\$1,794	\$937	2.51	1.91
<b>CZ12-2</b>	SMUD	PGE	\$772	\$1,181	\$620	1.25	1.90	\$1,226	\$1,794	\$937	1.31	1.91
<b>CZ13</b>	PGE	PGE	\$1,673	\$1,372	\$942	1.78	1.46	\$2,548	\$1,965	\$1,258	2.03	1.56
<b>CZ14</b>	SCE	SCG	\$1,165	\$1,175	\$620	1.88	1.89	\$1,923	\$1,901	\$937	2.05	2.03
<b>CZ14-2</b>	SDGE	SDGE	\$1,697	\$1,175	\$620	2.74	1.89	\$2,819	\$1,901	\$937	3.01	2.03
<b>CZ15</b>	SCE	SCG	\$1,423	\$1,456	\$942	1.51	1.55	\$2,128	\$2,110	\$1,258	1.69	1.68
<b>CZ16</b>	PGE	PGE	\$1,606	\$1,191	\$942	1.71	1.26	\$2,567	\$1,818	\$1,258	2.04	1.44

<sup>1</sup> Values in red indicate B/C ratios less than 1.



**Table 24: Mixed-Fuel Efficiency + PV Package Results, cont. (SAVINGS/COST PER APARTMENT)<sup>1</sup>**

Climate Zone	Elec Utility	Gas Utility	0.3 kW <sub>DC</sub> per Apartment					1 kW <sub>DC</sub> per Apartment				
			On-Bill Utility Cost Savings (2020 PV\$)	TDV Cost Savings (2020 PV\$)	Total Inc. Cost	On-Bill B/C Ratio	TDV B/C Ratio	On-Bill Utility Cost Savings (2020 PV\$)	TDV Cost Savings (2020 PV\$)	Total Inc. Cost	On-Bill B/C Ratio	TDV B/C Ratio
<b>CZ01</b>	PGE	PGE	\$2,389	\$1,582	\$1,253	1.91	1.26	\$7,466	\$5,029	\$3,469	2.15	1.45
<b>CZ02</b>	PGE	PGE	\$3,452	\$2,061	\$1,093	3.16	1.88	\$9,590	\$6,203	\$3,309	2.90	1.87
<b>CZ03</b>	PGE	PGE	\$3,428	\$1,982	\$1,093	3.14	1.81	\$9,687	\$6,079	\$3,309	2.93	1.84
<b>CZ04</b>	PGE	PGE	\$3,635	\$2,177	\$1,093	3.32	1.99	\$9,992	\$6,483	\$3,309	3.02	1.96
<b>CZ04-2</b>	CPAU	CPAU	\$1,863	\$2,177	\$1,093	1.70	1.99	\$5,184	\$6,483	\$3,309	1.57	1.96
<b>CZ05</b>	PGE	PGE	\$3,561	\$2,089	\$1,093	3.26	1.91	\$10,109	\$6,482	\$3,309	3.05	1.96
<b>CZ05-2</b>	PGE	SCG	\$3,561	\$2,089	\$1,093	3.26	1.91	\$10,109	\$6,482	\$3,309	3.05	1.96
<b>CZ06</b>	SCE	SCG	\$2,769	\$2,206	\$1,093	2.53	2.02	\$7,593	\$6,534	\$3,309	2.29	1.97
<b>CZ07</b>	SDGE	SDGE	\$3,805	\$2,283	\$1,093	3.48	2.09	\$10,818	\$6,739	\$3,309	3.27	2.04
<b>CZ08</b>	SCE	SCG	\$2,838	\$2,352	\$1,093	2.60	2.15	\$7,543	\$6,861	\$3,309	2.28	2.07
<b>CZ09</b>	SCE	SCG	\$2,570	\$2,393	\$1,093	2.35	2.19	\$7,285	\$6,948	\$3,309	2.20	2.10
<b>CZ10</b>	SCE	SCG	\$2,490	\$2,308	\$1,093	2.28	2.11	\$7,197	\$6,697	\$3,309	2.17	2.02
<b>CZ10-2</b>	SDGE	SDGE	\$3,670	\$2,308	\$1,093	3.36	2.11	\$10,636	\$6,697	\$3,309	3.21	2.02
<b>CZ11</b>	PGE	PGE	\$3,338	\$2,498	\$1,575	2.12	1.59	\$9,480	\$6,846	\$3,791	2.50	1.81
<b>CZ12</b>	PGE	PGE	\$3,242	\$2,406	\$1,253	2.59	1.92	\$9,299	\$6,694	\$3,469	2.68	1.93
<b>CZ12-2</b>	SMUD	PGE	\$1,680	\$2,406	\$1,253	1.34	1.92	\$4,855	\$6,694	\$3,469	1.40	1.93
<b>CZ13</b>	PGE	PGE	\$3,423	\$2,558	\$1,575	2.17	1.62	\$9,402	\$6,709	\$3,791	2.48	1.77
<b>CZ14</b>	SCE	SCG	\$2,682	\$2,626	\$1,253	2.14	2.10	\$7,820	\$7,707	\$3,469	2.25	2.22
<b>CZ14-2</b>	SDGE	SDGE	\$3,940	\$2,626	\$1,253	3.14	2.10	\$11,557	\$7,707	\$3,469	3.33	2.22
<b>CZ15</b>	SCE	SCG	\$2,832	\$2,764	\$1,575	1.80	1.76	\$7,676	\$7,342	\$3,791	2.03	1.94
<b>CZ16</b>	PGE	PGE	\$3,527	\$2,445	\$1,575	2.24	1.55	\$10,032	\$6,836	\$3,791	2.65	1.80

<sup>1</sup> Values in red indicate B/C ratios less than 1.



## Appendix E – Detailed Results All-Electric

**Table 25: All-Electric Efficiency Only Package Results (SAVINGS/COST PER APARTMENT)<sup>1,2</sup>**

Climate Zone	Elec Utility	Gas Utility	Apartments			Central Water Heating			Total	Savings (2020 PV\$)		Total Inc. Cost (\$)	B/C Ratio	
			Gas Savings (therms)	Elec Savings (kWh)	Year 1 Utility Cost Savings	Gas Savings (therms)	Elec Savings (kWh)	Year 1 Utility Cost Savings	Year 1 Utility Cost Savings	On-Bill Utility Cost Savings	TDV Cost Savings		On-Bill	TDV
CZ01	PGE	PGE	0.0	26	\$6	124.6	-899	-\$46	-\$40	-\$674	\$199	-\$446	0.7	>1
CZ02	PGE	PGE	0.0	48	\$17	114.3	-810	-\$38	-\$21	-\$238	\$528	-\$606	2.5	>1
CZ03	PGE	PGE	0.0	44	\$15	114.9	-811	-\$38	-\$23	-\$287	\$390	-\$606	2.1	>1
CZ04	PGE	PGE	0.0	62	\$20	110.7	-775	-\$35	-\$15	-\$102	\$625	-\$606	6.0	>1
CZ04-2	CPAU	CPAU	0.0	62	\$11	110.7	-775	-\$5	\$5	\$345	\$625	-\$606	>1	>1
CZ05	PGE	PGE	0.0	42	\$14	117.3	-830	-\$40	-\$26	-\$350	\$391	-\$606	1.7	>1
CZ05-2	PGE	SCG	0.0	42	\$14	117.3	-830	-\$66	-\$53	-\$827	\$391	-\$606	0.7	>1
CZ06	SCE	SCG	0.0	74	\$18	107.0	-744	-\$28	-\$10	\$153	\$612	-\$606	>1	>1
CZ07	SDGE	SDGE	0.0	81	\$25	105.9	-734	-\$43	-\$18	-\$58	\$665	-\$606	10.4	>1
CZ08	SCE	SCG	0.0	84	\$20	103.6	-717	-\$27	-\$6	\$227	\$693	-\$606	>1	>1
CZ09	SCE	SCG	0.0	83	\$20	103.5	-716	-\$27	-\$7	\$212	\$739	-\$606	>1	>1
CZ10	SCE	SCG	0.0	83	\$17	90.0	-709	-\$40	-\$23	-\$214	\$396	-\$853	4.0	>1
CZ10-2	SDGE	SDGE	0.0	83	\$25	90.0	-709	-\$59	-\$34	-\$478	\$396	-\$853	1.8	>1
CZ11	PGE	PGE	0.0	104	\$27	91.1	-723	-\$46	-\$19	-\$241	\$430	-\$371	1.5	>1
CZ12	PGE	PGE	0.0	93	\$24	93.9	-755	-\$51	-\$27	-\$414	\$288	-\$693	1.7	>1
CZ12-2	SMUD	PGE	0.0	93	\$13	93.9	-755	\$22	\$36	\$1,060	\$288	-\$693	>1	>1
CZ13	PGE	PGE	0.0	132	\$34	89.6	-711	-\$45	-\$11	-\$62	\$505	-\$371	6.0	>1
CZ14	SCE	SCG	0.0	80	\$17	92.2	-733	-\$42	-\$25	-\$258	\$305	-\$693	2.7	>1
CZ14-2	SDGE	SDGE	0.0	80	\$24	92.2	-733	-\$61	-\$36	-\$532	\$305	-\$693	1.3	>1
CZ15	SCE	SCG	0.0	145	\$30	73.8	-554	-\$28	\$3	\$332	\$832	-\$371	>1	>1
CZ16	PGE	PGE	0.0	119	\$28	107.8	-896	-\$64	-\$37	-\$621	\$127	-\$371	0.6	>1

<sup>1</sup> Values in red indicate B/C ratios less than 1.

<sup>2</sup> ">1" indicates cases where there are both incremental measure cost savings and energy cost savings.



**Table 26: Table 19: All-Electric Efficiency + PV Package Results (SAVINGS/COST PER APARTMENT)<sup>1,2</sup>**

Climate Zone	Elec Utility	Gas Utility	0.1 kW <sub>DC</sub> per Apartment					0.2 kW <sub>DC</sub> per Apartment				
			On-Bill Utility Cost Savings (2020 PV\$)	TDV Cost Savings (2020 PV\$)	Total Inc. Cost	On-Bill B/C Ratio	TDV B/C Ratio	On-Bill Utility Cost Savings (2020 PV\$)	TDV Cost Savings (2020 PV\$)	Total Inc. Cost	On-Bill B/C Ratio	TDV B/C Ratio
CZ01	PGE	PGE	\$78	\$692	-\$129	>1	>1	\$830	\$1,184	\$187	4.44	6.33
CZ02	PGE	PGE	\$782	\$1,120	-\$289	>1	>1	\$1,802	\$1,712	\$27	65.85	62.55
CZ03	PGE	PGE	\$741	\$975	-\$289	>1	>1	\$1,768	\$1,560	\$27	64.62	57.02
CZ04	PGE	PGE	\$955	\$1,240	-\$289	>1	>1	\$2,012	\$1,855	\$27	73.51	67.79
CZ04-2	CPAU	CPAU	\$904	\$1,240	-\$289	>1	>1	\$1,432	\$1,855	\$27	52.33	67.79
CZ05	PGE	PGE	\$730	\$1,018	-\$289	>1	>1	\$1,810	\$1,646	\$27	66.14	60.14
CZ05-2	PGE	SCG	\$254	\$1,018	-\$289	>1	>1	\$1,334	\$1,646	\$27	48.74	60.14
CZ06	SCE	SCG	\$935	\$1,231	-\$289	>1	>1	\$1,716	\$1,849	\$27	62.71	67.56
CZ07	SDGE	SDGE	\$1,049	\$1,302	-\$289	>1	>1	\$2,118	\$1,938	\$27	77.41	70.82
CZ08	SCE	SCG	\$1,014	\$1,337	-\$289	>1	>1	\$1,802	\$1,981	\$27	65.83	72.37
CZ09	SCE	SCG	\$924	\$1,390	-\$289	>1	>1	\$1,619	\$2,040	\$27	59.16	74.56
CZ10	SCE	SCG	\$480	\$1,023	-\$536	>1	>1	\$1,173	\$1,650	-\$219	>1	>1
CZ10-2	SDGE	SDGE	\$546	\$1,023	-\$536	>1	>1	\$1,570	\$1,650	-\$219	>1	>1
CZ11	PGE	PGE	\$660	\$1,052	-\$55	>1	>1	\$1,560	\$1,673	\$262	5.96	6.39
CZ12	PGE	PGE	\$476	\$900	-\$376	>1	>1	\$1,366	\$1,513	-\$60	>1	>1
CZ12-2	SMUD	PGE	\$1,513	\$900	-\$376	>1	>1	\$1,967	\$1,513	-\$60	>1	>1
CZ13	PGE	PGE	\$813	\$1,098	-\$55	>1	>1	\$1,687	\$1,691	\$262	6.44	6.46
CZ14	SCE	SCG	\$500	\$1,031	-\$376	>1	>1	\$1,259	\$1,757	-\$60	>1	>1
CZ14-2	SDGE	SDGE	\$589	\$1,031	-\$376	>1	>1	\$1,710	\$1,757	-\$60	>1	>1
CZ15	SCE	SCG	\$1,037	\$1,485	-\$55	>1	>1	\$1,741	\$2,139	\$262	6.65	8.17
CZ16	PGE	PGE	\$339	\$754	-\$55	>1	>1	\$1,299	\$1,381	\$262	4.96	5.27

<sup>1</sup> Values in red indicate B/C ratios less than 1.<sup>2</sup> ">1" indicates cases where there are both incremental measure cost savings and energy cost savings. Values in red indicate B/C ratios less than 1.0



**Table 27: All-Electric Package Results with PV, cont. (SAVINGS/COST PER APARTMENT)<sup>1,2</sup>**

Climate Zone	Elec Utility	Gas Utility	0.3 kW <sub>DC</sub> per Apartment					1.0 kW <sub>DC</sub> per Apartment				
			On-Bill Utility Cost Savings (2020 PV\$)	TDV Cost Savings (2020 PV\$)	Total Inc. Cost	On-Bill B/C Ratio	TDV B/C Ratio	On-Bill Utility Cost Savings (2020 PV\$)	TDV Cost Savings (2020 PV\$)	Total Inc. Cost	On-Bill B/C Ratio	TDV B/C Ratio
CZ01	PGE	PGE	\$1,582	\$1,676	\$504	3.14	3.33	\$6,660	\$5,123	\$2,719	2.45	1.88
CZ02	PGE	PGE	\$2,822	\$2,304	\$344	8.21	6.70	\$8,960	\$6,446	\$2,560	3.50	2.52
CZ03	PGE	PGE	\$2,796	\$2,146	\$344	8.13	6.24	\$9,055	\$6,242	\$2,560	3.54	2.44
CZ04	PGE	PGE	\$3,069	\$2,470	\$344	8.92	7.18	\$9,425	\$6,777	\$2,560	3.68	2.65
CZ04-2	CPAU	CPAU	\$1,960	\$2,470	\$344	5.70	7.18	\$5,281	\$6,777	\$2,560	2.06	2.65
CZ05	PGE	PGE	\$2,890	\$2,274	\$344	8.40	6.61	\$9,439	\$6,667	\$2,560	3.69	2.60
CZ05-2	PGE	SCG	\$2,414	\$2,274	\$344	7.02	6.61	\$8,962	\$6,667	\$2,560	3.50	2.60
CZ06	SCE	SCG	\$2,498	\$2,467	\$344	7.26	7.17	\$7,322	\$6,796	\$2,560	2.86	2.65
CZ07	SDGE	SDGE	\$3,154	\$2,575	\$344	9.17	7.49	\$10,166	\$7,030	\$2,560	3.97	2.75
CZ08	SCE	SCG	\$2,581	\$2,625	\$344	7.51	7.63	\$7,286	\$7,133	\$2,560	2.85	2.79
CZ09	SCE	SCG	\$2,314	\$2,691	\$344	6.73	7.83	\$7,028	\$7,247	\$2,560	2.75	2.83
CZ10	SCE	SCG	\$1,866	\$2,277	\$97	19.22	23.46	\$6,573	\$6,666	\$2,313	2.84	2.88
CZ10-2	SDGE	SDGE	\$2,594	\$2,277	\$97	26.72	23.46	\$9,560	\$6,666	\$2,313	4.13	2.88
CZ11	PGE	PGE	\$2,461	\$2,294	\$578	4.25	3.97	\$8,602	\$6,641	\$2,794	3.08	2.38
CZ12	PGE	PGE	\$2,256	\$2,125	\$257	8.78	8.28	\$8,313	\$6,413	\$2,473	3.36	2.59
CZ12-2	SMUD	PGE	\$2,421	\$2,125	\$257	9.43	8.28	\$5,596	\$6,413	\$2,473	2.26	2.59
CZ13	PGE	PGE	\$2,562	\$2,284	\$578	4.43	3.95	\$8,541	\$6,435	\$2,794	3.06	2.30
CZ14	SCE	SCG	\$2,017	\$2,482	\$257	7.85	9.67	\$7,155	\$7,563	\$2,473	2.89	3.06
CZ14-2	SDGE	SDGE	\$2,831	\$2,482	\$257	11.02	9.67	\$10,448	\$7,563	\$2,473	4.23	3.06
CZ15	SCE	SCG	\$2,445	\$2,793	\$578	4.23	4.83	\$7,289	\$7,371	\$2,794	2.61	2.64
CZ16	PGE	PGE	\$2,260	\$2,009	\$578	3.91	3.47	\$8,764	\$6,399	\$2,794	3.14	2.29

<sup>1</sup> Values in red indicate B/C ratios less than 1.<sup>2</sup> ">1" indicates cases where there are both incremental measure cost savings and energy cost savings. Values in red indicate B/C ratios less than 1.0



# Electric Vehicle Infrastructure Cost Analysis Report for Peninsula Clean Energy (PCE) & Silicon Valley Clean Energy (SVCE)

**To:** Peninsula Clean Energy & Silicon Valley Clean Energy

**From:** Tim Minezaki, Engineer II  
Cassidee Kido, Project Manager  
Ed Pike, Senior Engineer<sup>1</sup>  
Energy Solutions

**Date:** November 20, 2019

---

<sup>1</sup> Ed Pike contributed to this project while an employee at Energy Solutions.

## Table of Contents

<b>1. Executive Summary .....</b>	<b>1</b>
EV Infrastructure: New Construction vs. Retrofit: Customer costs .....	1
EV Infrastructure: Building size / Transformers .....	2
Reach Code Context .....	3
<b>2. Background and Purpose .....</b>	<b>4</b>
Purpose .....	4
California’s EV Infrastructure Policy Goals .....	4
CALGreen and Beyond .....	5
<b>3. Cost Modeling .....</b>	<b>8</b>
Scenarios .....	8
Buildings Types Descriptions .....	8
Results .....	10
Cost Savings Due to EVSE Installation in New Construction .....	14
EVSE Installation .....	14
Good Design Practices .....	14
Methodology .....	15
<b>4. Distribution Transformer Study .....</b>	<b>17</b>
Primary Transformers (utility-owned, often with customer costs) .....	17
Secondary Transformers (customer-owned) .....	19
Transformer-sizing and other considerations .....	20
<b>Appendix A: Cost Estimates by Type of Expense .....</b>	<b>1</b>
<b>Appendix B: Permitting and Inspection Costs .....</b>	<b>3</b>
<b>Appendix C: Methodology Details .....</b>	<b>4</b>
General Assumptions .....	4
Data Sources .....	4
Soft Costs .....	5
Permit and Inspection Fees .....	5
Construction Management .....	7
Raceways, Wire, and Termination Point .....	7
Demolition, Reconstruction, and Repaving .....	8
Contingencies .....	8
Transformers .....	9
Task Descriptions .....	10
<b>Appendix D: EV Capable Installation Configurations .....</b>	<b>1</b>

# 1. Executive Summary

---

California and the Bay Area are on the verge of a massive transformation. Current estimates<sup>2</sup> put electric vehicles (EVs) and plug-in hybrid vehicles (PHEVs) at a 5% market share but by 2030, that is expected to grow to 18-20%. Access to electric vehicles (EV) infrastructure is currently a major barrier for consumers' willingness to purchase electric vehicles. Meanwhile, several studies show that installation of EV infrastructure has significant costs, most notably in a retrofit scenario which has multiple cost factors. This report investigates infrastructure costs associated with EV infrastructure reach codes by building an EV cost effectiveness model, which examined three common building types and applied different EV infrastructure penetration rates. The model also studied utility-side infrastructure, such as distribution transformers, that potentially yield additional costs and affect a building owner's ability to comply with expanded EV infrastructure adoption, to understand the scale and frequency of those costs.

## EV Infrastructure: New Construction vs. Retrofit: Customer costs

The cost effectiveness model compared three building scenarios: (1) a medium 60-unit multi-unit dwelling (MUD) with 60 parking spaces, (2) a high-density 150-unit MUD with 150 parking spaces, and (3) a medium commercial office building with 60 parking spots. The model compares customer-side electrical infrastructure costs, such as wiring, switch gear, conduit, trenching, and secondary transformer. Primary transformer costs which are usually the responsibility of utilities, were considered separately in a later section<sup>3</sup>. The building models were then analyzed to compare the new construction requirements with the retrofit requirements. Results from Table 1 below show that costs for new construction were significantly lower, at almost four times as much per spot compared to the retrofit scenario. This indicates that increasing code requirements for charging infrastructure could potentially save significant amounts of money to building owners in the new construction context rather than waiting for tenants to become interested in electric vehicles, at which point significant costs related to invasive demolition and electrical infrastructure replacement would be necessary.

**Table 1. Estimated Cost of Installing EV Infrastructure (price per spot)**

Code Scenario:	Market Rate 25% Level 2 75% Level 1		Affordable Housing 10% Level 2 90% Level 1	
	New Construction	Retrofit <sup>4</sup>	New Construction	Retrofit
60-Unit MUD	\$1,410	\$4,443	\$1,049	+\$3,982
150-Unit MUD	\$1,197	\$4,101	\$1,002	+\$3,854
60-Space Office Building	\$1,166	\$3,232	N/A	N/A

<sup>2</sup> <http://businessportal.ca.gov/wp-content/uploads/2019/07/GoBIZ-EVCharging-Guidebook.pdf>

<sup>3</sup> Primary transformers are owned and operated by the utility and covered in a subsequent section but have cost components that can spill over to customer fees in multiple ways (PG&E Electric [Rule 16](#)).

<sup>4</sup> "New Construction" and "Retrofit" costs are relative to a CALGreen 2019 mandatory baseline building

In a retrofit context, there are significant known costs, such as those documented in this infrastructure costing model, but there are a high level of unknown opaque costs that either are born by the utility or by the customer, which while infrequent, can cause significant burden on a small number of building owners and tenants that are not present in New Construction projects. In addition, retrofitting parking structures for Americans with Disabilities Act (ADA) compliance can be a significant source of costs. Recent large-scale pilot studies conducted by the California utilities confirmed these cost burdens. For example, Pacific Gas & Electric’s (PG&E) EV Charge Ready program reported an “Average Cost per Port” costs for retrofit projects in their program to be almost \$18,000<sup>5</sup> with a range between \$10,000 and \$31,000<sup>6</sup>. The utility reports specifically call out ADA requirements and inconsistent requirements across jurisdictions, which required significant redesign costs for ADA compliance.

### EV Infrastructure: Building size / Transformers

Distribution transformers are a key piece of EV infrastructure and their costs and magnitude are heavily influenced by building size. For most situations, small buildings utilize shared distribution transformers split between multiple electrical accounts; medium buildings feature a dedicated utility-owned transformer and large buildings may feature several transformers, some are utility-owned and some are customer-owned depending on the uses and electrical design of the building. The particular trigger points between building sizes are influenced by the utility rules on electrical infrastructure equipment specifications and are not comparative between utilities. The graph below illustrates when certain costs become important to assist policy makers:

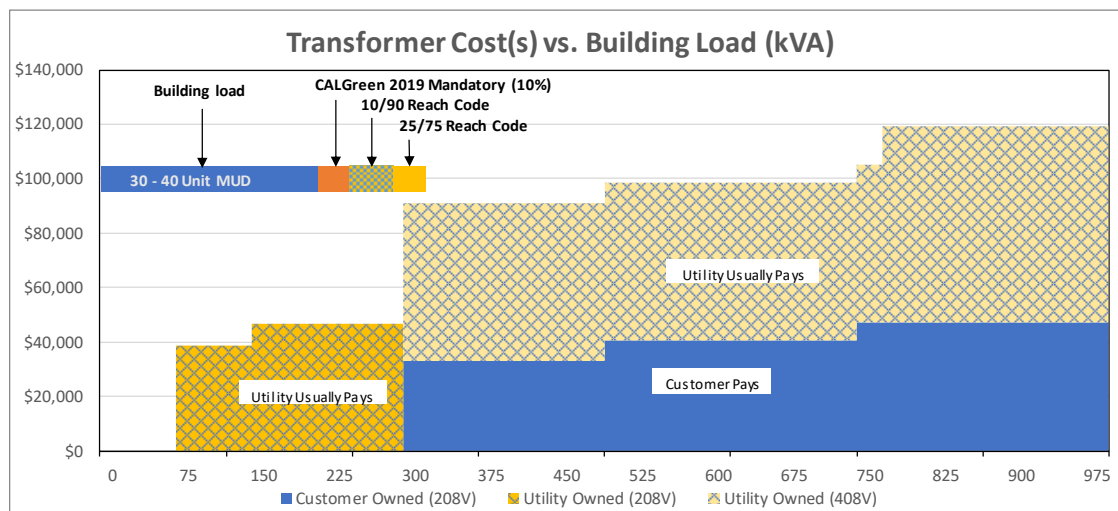


Figure 1: Costs of Transformers vs. Transformer system size (PG&E service territory)<sup>7</sup>

<sup>5</sup> Note that these costs include extensive design and re-design as well as utility side costs:

[Pacific Gas and Electric Company EV Charge Network Quarterly Report \(Q1-2019\)](#)

<sup>6</sup> [Q2 2019 Clean Transportation Program Advisory Council Meeting](#)

<sup>7</sup> This graph shows PG&E’s specific equipment sizing and is not comparable to other utilities. Calculations are based on estimates from the infrastructure cost model.

Costs of distribution and/or service-line upgrades are partially split between customer and utility. Customers are responsible for excavation, conduits, and protective structures. Utilities are typically responsible for wiring, metering, and transformer(s) (where necessary), however, utility costs can spill over into customer costs anytime that the costs exceed the preset “allowance” for a customer, based on historical energy usage.<sup>8</sup> In addition, if new load, does not materialize, the utility is able to assess additional charges for the difference in expected revenue. Currently, costs are described by California Public Utilities Commission’s (CPUC) Electric Rules 2, 15, and 16 which lay out which party is responsible for these costs, however, these costs are complicated, opaque, and hard to predict. Luckily, the CPUC is tracking costs related to EV infrastructure and has found that utility-side infrastructure upgrades triggered by EV-only projects are rare. To date, for PG&E’s service territory found only 3% of projects required distribution or service-line upgrades to accommodate EV infrastructure. However those costs spanned a wide cost range from \$14 to \$338,274 (additional details on this study can be found in the Transformers section below).

## Reach Code Context

This study investigated EV-infrastructure reach codes for communities in the jurisdiction of Silicon Valley Clean Energy (SVCE) and Peninsula Clean Energy (PCE), shown in Table 4 below. The study found that increasing the electric vehicle infrastructure requirements for new construction will save significant costs for all buildings when compared to a retrofitting. The study also found that transformer capacity limitations are not expected to occur very frequently and that even in the retrofit context most buildings should be able to meet the added load. For those that do not have significant capacity, utilizing lower power “Level 1” ports or load management may be a promising options.

Buildings near the boundary conditions highlighted above in Figure 1, in particular those that approach the 300 kVA capacity size<sup>9</sup>, face added risk of electrical infrastructure upgrade costs. For owners of those new buildings, the electrical systems would have to accommodate a second transformer and associated electrical infrastructure and the owner/developer would need to bear those costs estimated to be approximately \$50,000 (or significantly more in a retrofit context).

---

<sup>8</sup> Customers have an “allowance” based on their billing history to fund utility upgrades, but if allowance costs are exceeded, they are charged directly to the customer (PG&E Electric [Rule 15](#) & [Rule 16](#)). This allowance is based on the net revenue of the customer account. In addition, if the expected load does not materialize to use the system upgrade, the utility is permitted to recover their costs from the customer.

<sup>9</sup> For example, for a 30-40 unit MUD, this may be a consideration as shown in Figure 1.

## 2. Background and Purpose

---

### Purpose

The purpose of this report is to provide cost analysis data on electric vehicle infrastructure and to support and inform potential adoption of reach codes for cities and municipalities in Santa Clara and San Mateo counties. This report investigates potential reach codes that would 1) require “EV-ready” parking spaces, parking spaces which are already equipped with wiring and simply need an electric vehicle supply equipment (EVSE) to provide charging, and 2) increase the EV charging space requirements for market-rate housing, affordable housing, and commercial-office buildings. The CALGreen nonresidential code currently requires only that “EV capable” parking spaces be provided, which requires conduit and electrical panel capacity for a 40 ampere, 208/240-volt circuit serving the space, but does not require wiring nor EVSE installation and associated expenses. The following table describes these EV equipment tiers:

<b>EV Capable</b>	Includes conduit / raceways
<b>EV Ready (“Plug and play”)</b>	Includes full circuit with a receptacle / outlet
<b>EV Installed</b>	Includes full charging capability with EVSE

This cost report estimates the incremental costs associated with expanding EV infrastructure requirements beyond existing CALGreen 2019 mandatory requirements and compares the incremental construction costs from a new construction project with those of a retrofit project, utilizing an EV infrastructure cost model for three prototype buildings: (1) a 60-unit medium MUD, (2) a 150-unit large MUD, and (3) a medium-sized commercial office with 60 parking spaces. In all residential cases, we assumed one parking space per unit was assumed.

In addition, the report also investigates distribution current transformers, which will be increasingly important as electrical loads increase due to building and transportation electrification. Specifically, the utility rules and electrical load requirements were analyzed to determine boundary conditions where transformers would be required, the relative cost to incorporate them, and points at which multiple current transformers may be required, and the relative magnitude of those costs. The report also delineates specific situations for when transformers are utility owned and when they become a customer costs

### California’s EV Infrastructure Policy Goals

The increased proliferation of EV charging infrastructure supports many of California’s zero-emission vehicle adoption goals, including the objective to deploy 1.5 million zero-emission vehicles and 250,000 publicly

available EV charging stations including 10,000 direct current (DC) fast chargers by 2025.<sup>10</sup> California also has a goal of deploying 5 million ZEVs by 2030, which will require an even larger scale-up of public stations in addition to millions of non-public EV charging stations.<sup>11</sup> As of October 2019, California had approximately 18,500 public Level 2 charging ports at over 5,000 locations and approximately 3,200 public DC fast charging stations at over 700 locations.<sup>12</sup> California must make significant progress quickly, including updating CALGreen requirements and for local communities, investigating reach codes and the potential costs.

Parking spaces at workplaces and other non-residential buildings will be needed to accommodate a California vehicle fleet that is expected to have 18%-24% ZEVs in 2030. The future percentage of ZEVs will require a much higher percentage of parking spaces than the current CALGreen code requirements.<sup>13</sup>

EV charging infrastructure is a critical policy to help California reach its climate and EV adoption goals by providing opportunities at homes and workplaces as well as overcoming the critical challenge of “range anxiety” associated with EV adoption.<sup>14</sup> Surveys of communities in the Bay Area have shown that access to vehicle charging remains a main hurdle to wider adoption and in spite of that electric vehicle adoption is expected to grow significantly.

Building codes are an important way to facilitate access to EV charging so that residents, commuters, fleets, and car-sharing services can benefit from the significant operating cost advantages in a way that is cost-effective and accessible for all. Furthermore, because EV capable parking spaces can avoid or greatly reduce several types of costs associated with installing EV charging stations, public and private funding can achieve greater number of EV charging stations faster and more efficiently. Thus, increasing the levels of EV capable parking spaces beyond those set by CALGreen will lead to significant increases in EV charging infrastructure.

## CALGreen and Beyond

CALGreen is the first mandatory green building standards code in the nation and often serves as a model for other state and local governments across the country. It was originally developed in 2007 by the California Building Standards Commission (CBSC) to help meet the goals of AB 32 in reducing greenhouse gases to 1990 levels by 2020.<sup>15</sup> Every three years, the CALGreen code is reviewed, revised, and adopted statewide

---

<sup>10</sup> Former Governor Edmund G. Brown Jr. Executive Order B-16-2012 set the goal of placing 1.5 million zero-emission vehicles on California’s roads by 2025. Former Governor Edmund G. Brown’s Executive Order B-48-18 set the goal of 250,000 electric vehicle charging stations, including 10,000 DCFC charging stations, by 2025. In addition, the Charge Ahead California Initiative, [SB 1275 (De León), Chapter 530, Statutes of 2014] set a goal of placing 1 million zero- and near-zero-emission vehicles into service on California’s roads by 2023.

<sup>11</sup> Former Governor Edmund G. Brown Jr. Executive Order B-48-18 set the goal of 5 million zero-emission vehicles on California’s roads by 2030.

<sup>12</sup> Statistics are from the Alternative Fueling Station Locator (August 2019): [https://afdc.energy.gov/stations/#/analyze?region=US-CA&fuel=ELEC&ev\\_levels=dc\\_fast&country=US](https://afdc.energy.gov/stations/#/analyze?region=US-CA&fuel=ELEC&ev_levels=dc_fast&country=US)

<sup>13</sup> The California Air Resources Board’s EMFAC2017 database estimates that 21.0 million “LDA” (automobiles) and “LDT1” (light duty trucks) will be on the road in 2030. The database also estimates that 6.3 million additional “LDT2” (a second category of light duty trucks) will be on the road, some of which could be used for workplace commuting or other trips to non-residential buildings.

<sup>14</sup> “Range anxiety” refers to concerns about insufficient range and inability to find EV charging stations.

<sup>15</sup> “CALGreen”, Department of General Service, <https://www.dgs.ca.gov/BSC/Resources/Page-Content/Building-Standards-Commission-Resources-List-Folder/CALGreen>



along with other sections of Title 24 for residential and nonresidential buildings. The latest version of the CALGreen code takes effect on January 1, 2020 and is referred to by CBSC as “CALGreen 2019.”

The nonresidential CALGreen EV capable infrastructure requirements (California Code of Regulations, Title 24, Part 11 Sections 5.106 and A5.106) and the multifamily requirements (California Code of Regulations, Title 24, Part 11, Sections 4.106 and A4.106) which will take effect January 1, 2020 are shown in Table 2 and Table 3.

**Table 2. Summary of Mandatory and Voluntary CALGreen 2019 EV Capable Parking Space Standards for New Construction (Non-Residential)**

Current Mandatory	Voluntary Tier 1	Voluntary Tier 2
6%	8%	10%

**Table 3. Summary of Mandatory and Voluntary CALGreen 2019 EV Capable Parking Space Standards for New Construction (Residential)**

Current Mandatory	Voluntary Tier 1	Voluntary Tier 2
10%	15%	20%

The California Building Standards allow for more restrictive local amendments that are necessary because of local climatic, geological, or topographical conditions. Currently, two dozen municipalities in California have adopted local building codes that require more EV parking spaces than CALGreen and in many cases already require “EV ready” spaces with complete wiring.<sup>16</sup> Given the findings of this report, local jurisdictions that expand upon CALGreen requirements, could yield improved cost-savings potential for local businesses and developers.

As mentioned above, this report investigated the cost effectiveness of “EV reach codes” for market-rate housing, affordable housing, and commercial-office buildings. Table 4 below shows the following code levels that were investigated. Note that the baseline CALGreen 2019 levels are shown in “()” for comparative purposes.

---

<sup>16</sup> Pike, E. et. al. 2018. Driving Plug-in Electric Vehicle Adoption with Green Building Codes, August 17. ACEEE Summer Conference. Examples of agencies that are proposing local codes include Berkeley, Brisbane, San Jose, San Mateo, and many others.

Table 4. Summary of EV Reach Code Scenarios Analyzed

	MUD Market Rate (25/75)	MUD Affordable Housing (10/90)	Commercial Office
“EV Capable”	(10%)	(10%)	30% (6%)
Level 2	25%	10%	10%, EVSE
Level 1	75%	90%	10%

## 3. Cost Modeling

---

### Scenarios

The model investigates three prototype building models at the CALGreen 2019 mandatory requirement level. Those models were then analyzed for EV infrastructure installation costs as described in the scenarios described in Table 4 above for a new construction scenario and a retrofit scenario for a total of thirteen runs in the cost model. Table 5 below provides a high-level view of the building prototype models in terms of number of parking spaces, approximate building area, parking lot area, and number of stories. These buildings represent hypothetical building scenarios that are based on several assumptions and may not be reflective of any one building. Please refer to the appendix and methodology for additional details.

### Buildings Types Descriptions

*60-unit MUD:* A 60-unit apartment building with enclosed parking with 60 parking spaces to represent a medium-sized MUD building.

*150-unit MUD:* A 150-unit apartment building with enclosed parking with 150 parking spaces to representing a large MUD building.

*60-space Commercial Office:* An open parking lot with 60 spaces, to representing a medium-sized office building.

### TRANSFORMER-RELATED DEFINITIONS:

*Primary Transformer:* A utility-owned transformer used to convert medium voltage utility distribution lines (normally 12kV) to customer level power at either 480V/277V for large buildings or 208V/120V or 240V/120V for medium buildings. Primary transformers are owned and operated by the utility but any upgrade installation costs are partially split with the building owner.

*Secondary Transformer:* A customer-owned transformer that converts 480V/277V power down to 208V/120V service (or 240V/120V). Usually only necessary for medium-sized or large-sized buildings.

*Headroom:* Additional space left for transformer sizing to account for future unspecified load, typically 20%.

Table 5. Building Prototypes &amp; Baseline Conditions

Building Type	60-unit MUD	150-unit MUD	60-Space Office
Number of Units	60	150	n/a
Total number of parking spaces required	60	150	60
Building Area [ft <sup>2</sup> ]	65,000	163,000	20,000
Number of Floors	4 to 5	8 to 9	1 to 3
Parking Lot Size [ft <sup>2</sup> ]	14,000	38,800	14,000
Parking Lot Type	1-level structure	2-level structure	stand-alone lot
CALGreen Level 2 Charging Requirement	6	15	4
Building Load [kVA]	292	700	98
CALGreen EV Load [kVA]	43	86	29
Total Load [kVA]	335	786	126
Load with Headroom [kVA]	402	944	152
Percent of load from CalGreen EV Load	11%	11%	18%
Secondary Transformer [kVA] (480V -> 208V / 120V)	500	1000	225
Primary Transformer [kVA] (12kV -> 480V / 277V)	750	1000	300

Table 6. Load Comparisons across Scenarios

Building Type	60-Unit MUD <sup>17</sup>		150-Unit MUD		60-Space Office Building
Baseline Building Load [kVA]	292		700		98
Baseline Level 2 [# of Ports] (CALGreen 2019)	6		15		4
Baseline EV Load [kVA] (CALGreen 2019)	43		86		29
Capacity Requirement (with headroom)	402 kVA		944 kVA		152 kVA
Secondary Transformer Size	500 kVA		1000 kVA		300 kVA
Reach Code Scenario	Market Rate	Affordable Housing	Market Rate	Affordable Housing	10% L2 40% L1
Additional Level 2 Ports	+12 ports	0 ports	+22 ports	0 ports	+2 ports
Additional Level 1 Ports	+45 ports	+54 ports	+113 ports	+135 L1	+24 ports
Additional EV Load [kVA]	+95 kVA	+54 kVA	+257 kVA	+156 kVA	+33 kVA
TOTAL EV Load [kVA]	430 kVA	389 kVA	1043 kVA	942 kVA	160 kVA
Secondary Transformer Size	500 kVA	500 kVA	1500 kVA <sup>18</sup>	1000 kVA	300 kVA
Percent of load from EVs	32%	25%	33%	26%	39%

<sup>17</sup> Some of the capacity loading calculations do not appear additive. For any parking scenario with more than 10 chargers, we utilized a diversity factor of 80% to account for non-coincident charging.

<sup>18</sup> Our cost model assumes that for a retrofit scenario, a second 500 kVA transformer would be installed rather than demolition

## Results

The results of the cost analysis model show that installing EV capable spaces as a stand-alone retrofit are close to four times as expensive compared to during new construction. Costs for these project types are shown in Table 7 and Table 9 with detailed breakdowns in Appendix A.

Several factors related to *building types* affect these results:

- Costs per space are generally higher for small buildings with a small number of retrofits for EV capable infrastructure. Smaller projects must divide fixed costs among fewer spaces than larger projects.
- Buildings that are at the cusp of needing an upgraded switch gear or transformers represent **significant cost** increases to add electric vehicles, particularly in a retrofit context where there are large costs from demolition and site disruption. The prototypes we studied were unable to illustrate this point so additional narrative about these costs have been added in the ‘Distribution Transformers’ section. For this study, the prototype buildings we used only surpassed the baseline transformer capacity on one scenario – and the loading was such that we did not expect significant demolition was not expected. Switch gear and secondary transformer costs were included but did not include added costs for demolition, removal, or expansion of electrical rooms<sup>19</sup> -or- any costs associated with utility-owned primary transformer upgrades<sup>20</sup>.
- Our cost model found that enclosed parking was less expensive than an open parking lot. This is because surface-mounted conduit is often less expensive to retrofit than trenching, and repairing surface parking areas. However, enclosed parking is usually much more expensive when considering ADA compliance due to grading, restriping, and accounting for path of travel.

Several factors related to *project type* affect these results:

- Installing conduit in new construction is much less expensive than retrofitting it later for several reasons.
  - Demolition, disposal of materials, and repair of surface parking areas is not required.
  - Conduit can be installed directly underneath parking rather than routing around existing barriers. In addition, less expensive PVC (plastic) conduit can be installed in the parking floor (tied to rebar before concrete is poured) rather than surface mounted later. While wiring of branch circuits is not included in this report, these shorter lengths will also reduce wiring costs.
  - Running conduit through existing buildings will likely require demolition of walls, and potentially through floors as well<sup>21</sup>
  - Requiring that new electrical service panels contain capacity for EV capable infrastructure can achieve economies of scale and avoid the situations where an electrical room must be

---

<sup>19</sup> Demolition, Removal, and expansion of electrical rooms were not considered because they are highly dependent on site-specific factors that are difficult to estimate from the generic building prototypes we developed.

<sup>20</sup> Utility-side transformer costs are analyzed in a separate section

<sup>21</sup> X-ray cameras are usually used to prevent damage to concrete structures.

expanded to add additional charging. This latter cost is not included in the model, and thus, some retrofits for EV capable spaces would be significantly more expensive.

- Compared to stand-alone retrofits, incremental “soft” costs will be lower for new construction. This is because fixed costs not related to EV capable spaces will already be required for construction and the incremental cost will be much lower.<sup>22</sup>
- Equipment needed for trenching of surface parking will likely already be on-site during new construction, limiting costs.

**Table 7. Incremental Costs Required to Install EV Infrastructure**

Code Scenario	Market Rate 25% Level 2 75% Level 1		Affordable Housing 10% Level 2 90% Level 1	
	New Construction	Retrofit	New Construction	Retrofit
60-Unit MUD	\$76,142	\$239,909	\$56,629	\$215,051
150-Unit MUD	\$161,550	\$553,682	\$135,301	\$520,227
60-Space Office Building	\$34,971	\$96,970	N/A	N/A

---

<sup>22</sup> Pike, Ed and Steuben, Jeff. “Plug-In Electric Vehicle Infrastructure, Cost-Effectiveness Report.” 2016

Table 8. Number of EV Charging Ports per Scenario

Code Scenario:	CALGreen 2019	Market Rate 25% Level 2 75% Level 1	Affordable Housing 10% Level 2 90% Level 1
60-Unit MUD	6 L2	15 L2 45 L1	6 L2 54 L1
150-Unit MUD	15 L2	38 L2 112 L1	15 L2 135 L1
60-Space Office Building	4 L2	6 L2 24 L1	N/A

Table 9. Estimated Cost of Installing EV Infrastructure (price per spot)<sup>23</sup>

Code Scenario:	Market Rate 25% Level 2 75% Level 1		Affordable Housing 10% Level 2 90% Level 1	
Building Type	New Construction	Retrofit	New Construction	Retrofit
60-Unit MUD	\$1,410	\$4,443	\$1,049	\$3,982
150-Unit MUD	\$1,197	\$4,101	\$1,002	\$3,854
60-Space Office Building	\$1,166	\$3,232	N/A	N/A

Figure 2, 3, and 4 summarize the major categories of costs such as: demolishing and repairing parking lots and sidewalks, upgrading electrical service panels, obtaining permits and inspections, and installing conduit and associated equipment. CALGreen is the baseline cost - all other scenarios are costs *in addition* to the CALGreen baseline. Tables showing the specific dollar amounts and percent of total project cost by category are shown in the Appendix A.

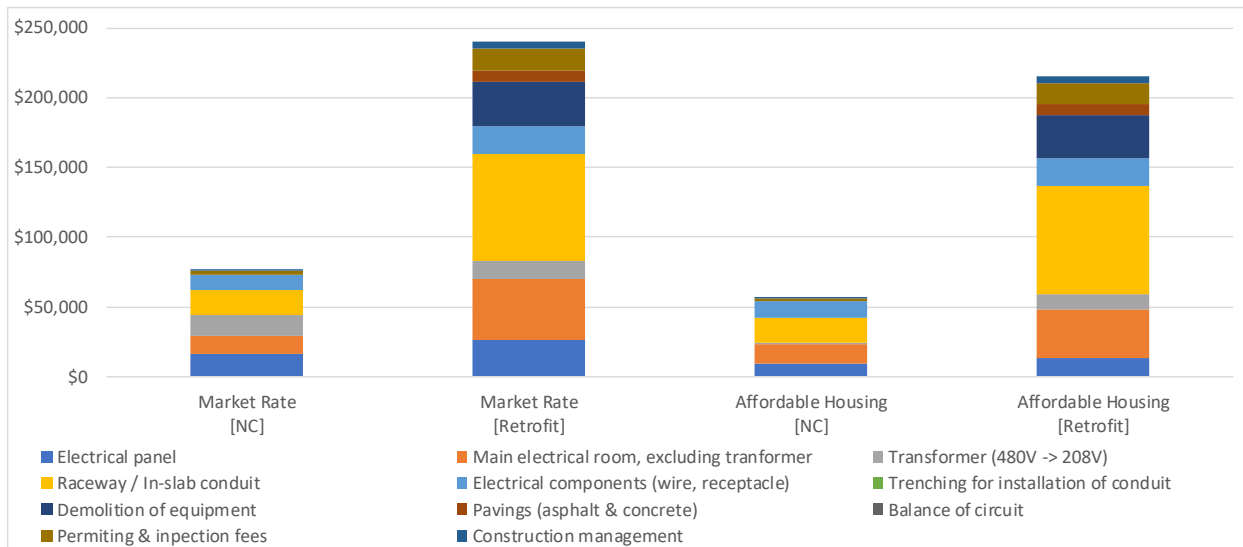


Figure 2. Cost Break-Down for 60-unit MUD

<sup>23</sup> Price per spot is calculated against the baseline CALGreen level. For illustrative purposes: 60-unit scenarios are divided by 54 spaces, which represents the incremental number of spaces added for the incremental cost.

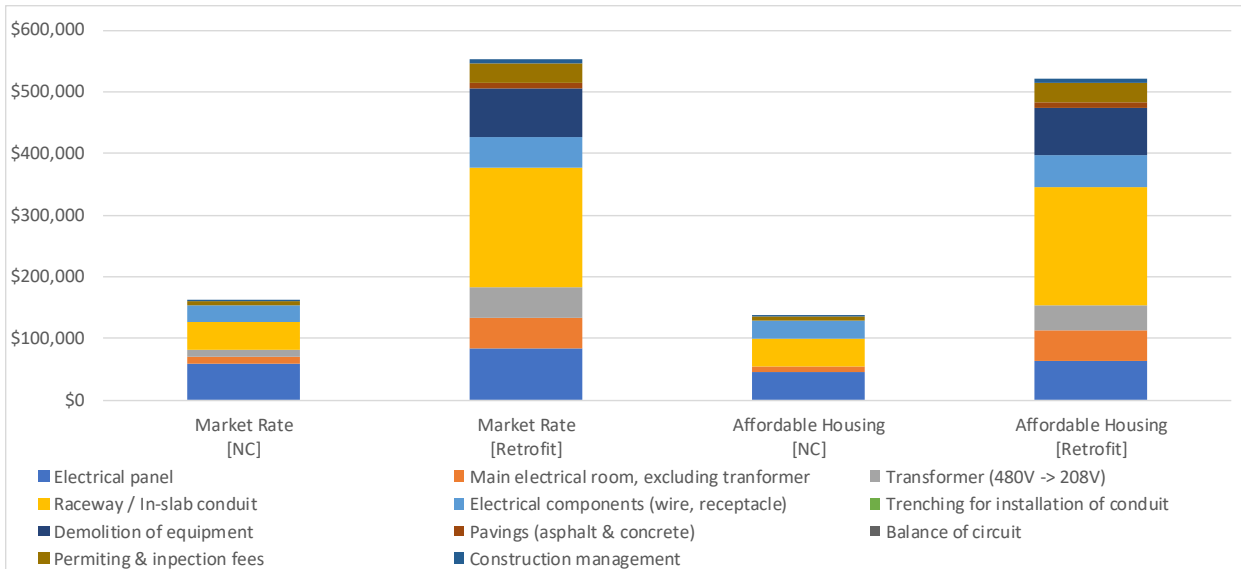


Figure 3. Cost Break-Down for 150-unit MUD

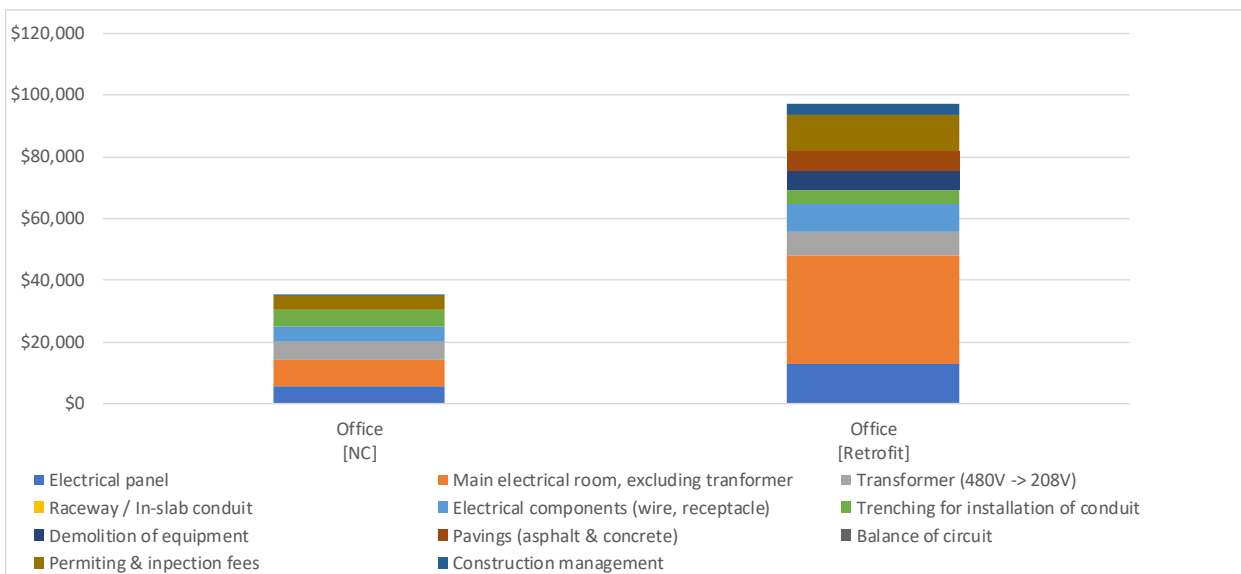


Figure 4. Cost Break-Down for 60-space Commercial Office (assumes surface-level parking)

Building code requirements for EV capable parking spaces can also reduce or avoid non-cost barriers such as coordinating between building owners/operators and tenants, potential loss of productive time for tenants during construction, lack of awareness of EV charging as an option, and the additional time and expense of undertaking a stand-alone EV charging infrastructure construction project. This study does not include specific accessibility requirements such as slope, vertical clearance, and path of travel and any of the associated costs with restriping, curb-cutting, or re-grading to meet ADA requirements, however a rough contingency to account for these ADA requirements has been included. For additional information on ADA compliance, the Governor’s Office of Business and Economic Development recently released an Electric



Vehicle Charging Station Permitting Guidebook which highlights several ADA-specific issues around accessibility.<sup>24</sup>

## Cost Savings Due to EVSE Installation in New Construction

This section discusses the benefits of requiring EVSE installation in a subset of spaces. This section also discusses the potential benefits of good design practices to greatly reduce the potential for expensive redesign and engineering to meet accessibility requirements for buildings subject to Title 24, Part 2, Chapter 11B.

### EVSE Installation

We note that several local jurisdictions already require the complete installation of an EVSE on a complete electrical circuit for some parking spaces in nonresidential new construction including Carlsbad, Contra Costa County, Palo Alto and Santa Cruz. Installing a complete electrical circuit, including wiring and circuit breakers, will achieve better economies of scale and avoid the overhead and time needed to hire an electrician. This includes the need for tenants to get approvals from building owner for an electrical wiring retrofit (for the residential sector, condo owners would typically need approval from the homeowners association).

In addition, many EVSE installation tasks can be completed during new construction at much lower cost than retrofitting later, such as:

- Retrofitting concrete pads for pedestals if needed to mount EVSE (and any associated payment kiosks) and/or bollards if needed, including concrete cutting, excavation, and repair;
- Mounting brackets for EVSE installed on walls or pillars;
- Any conduit or infrastructure needed to provide data for EVSE that are networked;
- Accessibility, as discussed further below in the Good Design Practices section;
- Soft costs such as customer (or customer representative) and contractor project management; project planning including design, engineering, and permitting; contractor mobilization; and any additional retrofit tasks needed for EVSE installations;
- Lighting, if required and not already installed on-site;
- Additional site-specific, real-world contingencies.

Installing a complete circuit with an EVSE installed will reduce burdens on local building officials and thus will tend to increase code compliance. Inspectors can more easily verify that a complete circuit is installed and operating correctly with an EVSE installed, rather than determining the specific electrical components that would be required for EV capable spaces.

### Good Design Practices

Several local jurisdictions have adopted building codes that require good design practices to facilitate compliance with accessibility requirements for buildings subject to the CalGreen requirements, California

---

<sup>24</sup> <http://businessportal.ca.gov/wp-content/uploads/2019/07/GoBIZ-EVCharging-Guidebook.pdf>

Code of Regulations Title 24, Part 2, Chapter 11B Section 11B-812. Section 11B-812 requires that a facility providing Electric Vehicle Charging Stations (EVCS), i.e. a parking spaces with an EVSE installed, for public and common use also provide one or more accessible EVCS, as specified in Table 11B-228.3.2.1. Chapter 11B applies to certain facilities including, but not limited to, public accommodations and publicly-funded housing (see Part 2, Section 1.9 of the California Building Code). It does not require review prior to construction of whether a building is designed to allow compliance with these requirements, and local codes require good design practices to fill this gap.

These local codes typically require that projects subject to the California Code of Regulations Title 24, Part 2, Chapter 11B, document how many accessible EVCS would be required as per Title 24, Chapter 11B to convert all required EV capable or EV ready parking spaces to EVCS. They also typically require that the builder demonstrate that the facility is designed such that compliance with accessibility standards, including Chapter 11B accessible routes, will be feasible for the required accessible EVCS at the time of EVCS installation.<sup>25</sup>

We note that retrofitting spaces that were not designed to facilitate compliance with accessibility requirements can be very expensive. For instance, this study finds that removing and repairing about 100 to 300 linear feet of surface parking that add conduit to non-accessible parking spaces for a small or medium facility can cost \$11,500 to \$32,000 in demolition and repair costs. While the scope of work for accessibility retrofits may be different from the conduit installation task, this information indicates that the types of costs required for accessibility retrofits (absent good design practices) may be similarly significant and in retrofit contexts may be cost prohibitive, space prohibitive, or both.

## Methodology

The methodology for this report is similar to prior 2016 reports for the City of Oakland (with funding from the City of Oakland and grant funding from the California Energy Commission), and for the City and County of San Francisco (with funding from Pacific Gas & Electric and in-kind support from the City and County of San Francisco).<sup>26 27</sup>

The cost analysis model that breaks each scenario and number of EV capable parking spaces into individual tasks and quantities, as shown in Appendix C. The model also contains estimates for the costs of each job task. Estimates of retrofit and new construction costs per job task are largely based on RS Means, a construction cost reference handbook for residential and nonresidential hardware and related installation

---

<sup>25</sup> For instance, section 11B-812 requires that "Parking spaces, access aisles and vehicular routes serving them shall provide a vertical clearance of 98 inches (2489 mm) minimum." It also requires that parking spaces and access aisles meet maximum slope requirements of 1 unit vertical in 48 units horizontal (2.083 percent slope) in any direction at the time of new building construction or renovation. Section 11B-812.5 contains accessible route requirements. In addition, Title 24 Part 11 Section 4.106.4.2 requires that developers meet certain aspects of accessibility requirements at the time of new construction for a limited number of parking spaces.

<sup>26</sup> Pike, Ed and Steuben, Jeff. "Plug-In Electric Vehicle Infrastructure, Cost-Effectiveness Report." 2016; and Pike, Ed, Jeffrey Steuben, and Evan Kamei. 2016. "Plug-In Electric Vehicle Infrastructure Cost-Effectiveness Report for San Francisco."

<sup>27</sup> Pike, Ed, Jeffrey Steuben, and Evan Kamei. 2016. "Plug-In Electric Vehicle Infrastructure Cost-Effectiveness Report for San Francisco."

costs.<sup>28</sup> Additional costs for contractor labor, permits, architectural drawings, plans, site and/or load studies (for retrofit projects), inspections, and local permit and inspection fees are based on the resources listed in Appendix B and C. Additional information used to model these costs includes feedback from industry and utility experts, engineering estimates, and direct experience. For additional details on the methodology and information specific to the EV capable parking space details, please see Appendix C and Appendix D.

The cost analysis model includes hypothetical installation scenarios to compare costs between different numbers of EV capable parking space for new construction and retrofit projects. Actual project costs and configurations will vary; these cases are intended to provide representative examples for comparison purposes rather than to estimate site-specific costs. The model excludes project-specific costs outside the scope of EV capable parking space building code compliance such as acquisition and installation of the EVSE, signage, lighting, pedestal mounts, bollards, wheel stops, any required accessibility retrofit, and any other factors outside of CALGreen EV capable parking spaces requirements.<sup>29</sup> (Codes that address accessibility during alterations and additions such as the City of Fremont, City of Oakland, and City and County of San Francisco local codes can result in significant cost savings compared to changing these design parameters later as part of a stand-alone retrofit project.<sup>30</sup>)

Recent editions to this model have added secondary transformers costs and electrical room costs (switchgear). The model still excludes utility-side infrastructure, such as concrete transformer pads, utility service connections, and associated demolition, to accommodate potential swap-out for a larger capacity primary transformer. Additional information on those costs can be found in the Table 7 of the Transformers section below.

Furthermore, the scenarios do not include sub-metering or separate metering equipment, which are optional, but could be selected by a building owner to access a special electricity rate.<sup>31</sup> Primary model costs are based on the City of Sacramento with a correction for PCE and SVCE's service area based on an average of San Jose and San Mateo's labor and material costs for the first quarter of 2019.

---

<sup>28</sup> For additional information, see [www.rsmeans.com](http://www.rsmeans.com).

<sup>29</sup> RS Means specifies a range of potential design costs, while noting that design costs will likely be 50 percent higher for alterations. We note that wheel stops may cost \$150-\$200 each and bollards may cost \$500-\$750 each based on input from an installer and RS Means costs for equipment types similar to bollards.

<sup>30</sup> San Francisco Green Building Code 2016:

[http://library.amlegal.com/nxt/gateway.dll/California/sfbuilding/greenbuildingcode2016edition?f=templates\\$fn=default.htm\\$3.0\\$vid=amlegal:sanfrancisco\\_ca\\$sanc=JD\\_GreenBuilding](http://library.amlegal.com/nxt/gateway.dll/California/sfbuilding/greenbuildingcode2016edition?f=templates$fn=default.htm$3.0$vid=amlegal:sanfrancisco_ca$sanc=JD_GreenBuilding)

<sup>31</sup> A sub-meter may be a desirable add-on for some building owners or PEV drivers to allocate electricity costs and/or provide access to utility PEV charging electricity tariffs, though some special electricity rates for PEV owners are available through whole-house rates and utilities are also conducting pilots of metering via electric vehicle service equipment. The authors believe that builders wishing to install a socket for a sub-meter at the time of new construction may achieve cost savings compared to retrofits but have not quantified this potential.

## 4. Distribution Transformer Study

---

One important distinction in transformer classifications is between primary transformers (which are owned and operated by the utility) and secondary “step-down” transformers (which are owned and operated by a building owner). The main distinguishing factor between these is the overall building load and the particular utility rules which specify trigger points for the electrical design. For most situations, small buildings utilize shared distribution primary transformers split between multiple electrical accounts; medium-sized buildings feature a dedicated utility-owned primary transformer; and large buildings may feature a dedicated utility-owned primary transformer along with secondary transformer(s) depending on the electrical design of the building.

### Primary Transformers (utility-owned, often with customer costs)

Primary transformers are needed to convert medium voltage utility distribution lines (normally 12kV) to customer level power at either 480V/277V for large buildings or 208V/120V or 240V/120V for medium buildings (for the purposes of this report, small buildings are on a shared transformer). Primary transformers are owned and operated by the utility but costs are partially split with the building owner. The costs borne by the utility operate with a ceiling, insulating utilities from the ballooning costs of the upgrades, allowing any excess above to be charged to the customer. This mechanism is known as an “allowance,” effectively a budget for infrastructure upgrades funded through the electric rates. For PG&E, it is governed by Electric Rule 2<sup>32</sup>, Electric Rule 15<sup>33</sup> & Electric Rule 16<sup>34</sup> which together lay out the rules for expanding service, extending distribution lines, and upgrading transformers. The allowance is dictated by these rules and based on historical electrical usage. The following excerpt is from Electric Rule 15:

$$\text{Allowance} = \frac{\text{Net Revenue}}{\text{Cost-of Service Factor}}$$

where the Cost of Service Factor is the annualized utility-financed Cost of Ownership as (N)  
stated in Electric Rule 2. (N)

As written, these formulas and rule exceptions are complex because they apply for all electrical infrastructure situations, including agricultural, industrial, or rural contexts. However, generally-speaking, utility infrastructure upgrades have costs that are broken down between the building owner and the utility. For utility-owned transformers, the building owner will pay for the following nine elements:

- 1- a load study from the utility’s service planning department,
- 2- trenching,
- 3- excavation
- 4- backfill,
- 5- compaction,
- 6- conduit,

---

<sup>32</sup> [https://www.pge.com/tariffs/tm2/pdf/ELEC\\_RULES\\_2.pdf](https://www.pge.com/tariffs/tm2/pdf/ELEC_RULES_2.pdf)

<sup>33</sup> [https://www.pge.com/tariffs/tm2/pdf/ELEC\\_RULES\\_15.pdf](https://www.pge.com/tariffs/tm2/pdf/ELEC_RULES_15.pdf)

<sup>34</sup> [https://www.pge.com/tariffs/tm2/pdf/ELEC\\_RULES\\_16.pdf](https://www.pge.com/tariffs/tm2/pdf/ELEC_RULES_16.pdf)

- 7- substructures (boxes and pads),
- 8- pavings (cut, patch, and final repair), and
- 9- taxes and cost of ownership.

Meanwhile, the utility will pay (up to the allowance) for metering, wiring, and transformers. For any excess work required above the allowance, an advance is required by the customer, but can be converted to a monthly payment. If the revenue for the utility does not end up materializing in the first ten years, utilities have a mechanism to claw back funds called “deficiency billing.”

The CPUC has been tracking service and distribution system upgrades for EV-projects from the three major California Investor-Owned Utilities, publishing their 7<sup>th</sup> annual report in April 2019<sup>35</sup>. The study indicates the relative frequency and magnitude of utility-side infrastructure costs that include both service upgrades and **primary** transformer upgrades. While this equipment is owned and operated by the utility, the customer will pay for upgrade costs until their allowance is exceeded.

In many cases this allowance is insufficient and costs can spread over to the customer in lump sum costs ahead of construction and/or higher monthly costs. The following table is pulled from the CPUC report and provides a high-level summary of these costs:

**Table 10: Summary of Service Line and Distribution System Upgrades**

	PG&E	SCE	SDG&E	Total
<b>Residential Customers</b>				
Estimated PEV customers through December 31, 2018	216,845	163,594	34,833	415,272
<b>Residential Upgrades</b>				
Number of PEV-related Infrastructure Checks Completed	10,138	Not tracked	Not tracked	N/A
Number of PEV-related Service Line and/or Distribution System Upgrades	323	243	52	618
Total Costs Incurred by Utility for Upgrades	\$6,627,544	\$351,675	\$53,365	\$7,032,584
Range of Costs for Upgrades	\$14 to \$338,274	\$1 to \$30,067	\$47 to \$10,958	N/A
Average Cost for Distribution System Upgrade	\$19,262	\$4,514	\$4,089	N/A
Average Cost for Service Line Upgrade	\$1,168	\$1,382	\$730	N/A
Number of Service Line Upgrades Exceeding Residential Allowance	39	33	0	72
Current Residential Allowance	\$2,431	\$3,084	\$3,241	N/A
Amount of Foregone Billings to Customers for Service Line Upgrades Pursuant to "Common Facility Treatment" Policy Exemption for PEVs	\$190,207	\$37,887	\$0	\$228,094

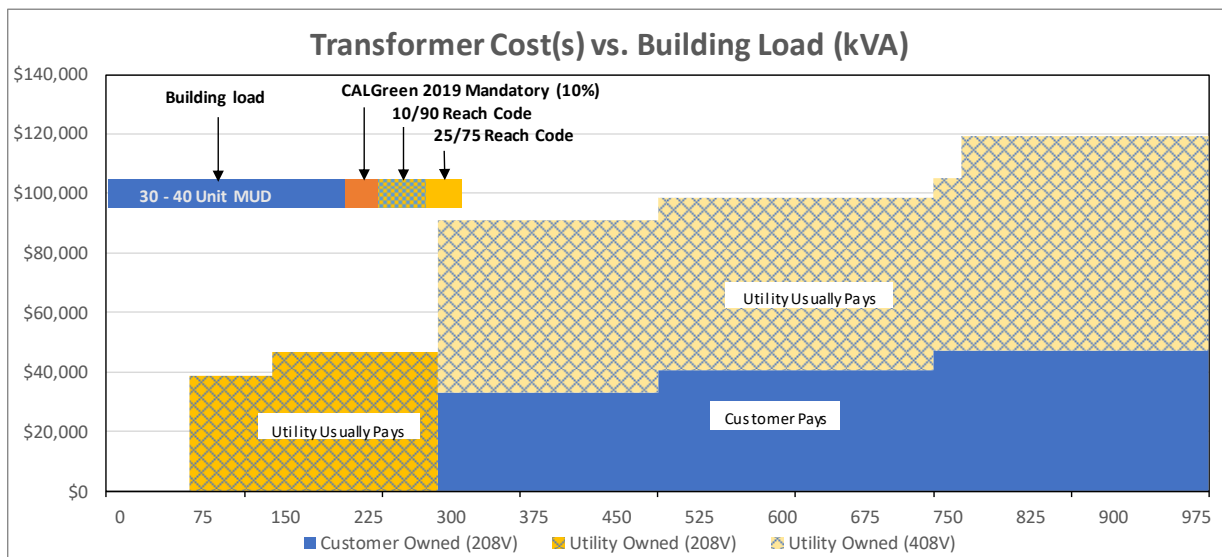
As shown above, PG&E’s service territory indicates just over 3% (323 service line upgrades of 10,138 PEV-related Infrastructure Checks) of sites required distribution or service-line upgrades to accommodate EV infrastructure, demonstrating projects that exceed existing transformer capacity is not common yet. And of these less than 0.4% (39) exceeded the residential allowance resulting in additional costs to the building owner beyond the baseline upgrade costs. Two large caveats should be highlighted here. The first is that most of

<sup>35</sup> [7<sup>th</sup> Joint IOU Electric Vehicle Load Research Report: April 2019 \(CPUC\)](#)

these early EV installations are residential customers and the second is that overall demand for charging infrastructure is increasing and it can be expected that more ports will be installed per parking lot than in the past. In addition, local jurisdictions may have local restrictions regarding placing transformers in public right of ways necessitating alternative siting such as placing transformers within the property line and under owner cost. The most important considerations are the “Range of Costs for Upgrades” (\$14 - \$338,274) and the “Average Cost for Distribution System Upgrade” (\$19,262) which indicate both a very wide range between projects and the average magnitude for transformers upgrades in PG&E territory. It should be noted that the distribution upgrade costs across utilities are significant with PG&E (\$19,262) incurring much higher costs than those of SCE (\$4,514) and SDG&E (\$4,089).

### Secondary Transformers (customer-owned)

Secondary transformers are required from larger buildings based on the electrical service being provided by the utility. These rules are pre-determined by the utility’s electric rules. In the context of this report, secondary transformers are those that convert 480V/277V power down to 208V/120V service. PG&E’s Unit Cost Guide<sup>36</sup>, PG&E’s Greenbook<sup>37</sup>, and RS Means were investigated to develop a characterization of electrical infrastructure costs (transformers) vs. building load (kVA). In the graph below, primary transformers costs are indicated in gold/yellow with blue-accented patterns<sup>38</sup> and secondary transformers costs are indicated in solid blue (costs associated with site preparation are not included). In addition to this, load estimates that were utilized for the cost effectiveness model are overlaid to provide a rough back-of-the-envelope load calculation for MUDs, to illustrate when certain costs become important in order to assist policy makers of the relative situations in which these triggers would occur:



<sup>36</sup> PG&E Unit Cost Guide - April 2019

<sup>37</sup> 2017-2018 PG&E Greenbook: Electric & Gas Service Requirements:(<http://www.pge.com/greenbook>)

<sup>38</sup> The blue accent is to highlight that these costs often end up part of customer costs.

**Figure 5: Costs of Transformers vs. Transformer system size (PG&E service territory)<sup>39</sup>**

The figure above shows the magnitude of these transformer costs along with boundary points for small/medium and medium/large buildings utilizing rough estimates for number of units in a MUD with electric vehicle charging equivalent CALGreen 2019 mandatory levels. The sample number of MUDs shown in the figure above are meant to point out sizeable non-linear costs associated with transformer upgrades for this climate and this utility. In particular, attention should be paid to the 300kV load point which may cause considerable cost escalation as the electrical service would switch from 208V/120V to 480V/277V. As mentioned previously, this graphic is high-level, intended for policy makers and does not provide appropriate level of detail for a specific microclimate or a specific site.<sup>40</sup>

## Transformer-sizing and other considerations

Electrical designers typically oversize transformers for future unspecified loads as “transformer headroom.” A typical approach to transformer sizing is to obtain the calculated design load from the electrical schedule (building plan documents) and add 20% spare capacity for future load growth to be shown in the equipment schedule, unless otherwise directed by the facility based on design parameters<sup>41</sup>. Due to the large step-wise nature of transformers, it is possible that after accounting for headroom significantly more capacity is afforded. The table below illustrates this for the building models produced for this report:

**Table 11. Transformer Sizing & Capacity**

Building Type	60-Unit MUD		150-Unit MUD		60-Space Office Building
Baseline Building Load [kVA]	292		700		95
Baseline EV Load [kVA] (CALGreen 2019)	43		99		29
Capacity Requirement [kVA]	335 kVA		786 kVA		126 kVA
Capacity Requirement (with 20% headroom) [kVA]	402 kVA		944 kVA		152 kVA
Secondary Transformer Size [kVA]	500 kVA		1000 kVA		300 kVA
Overall Unused Capacity [kVA (% unused)]	165 kVA (33%)		214 kVA (21%)		174 kVA (58%)
Code Scenario	Market Rate	Affordable Housing	Market Rate	Affordable Housing	10% L2 40% L1
Additional Level 2 Ports	+12 L2	0	+22 L2	0	+2 L2
Additional Level 1 Ports	+45 L1	+54 L1	+113 L1	+135 L1	+24 L1
Additional EV Load [kVA]	+95 kVA	+54 kVA	+257 kVA	+156 kVA	+33 kVA
TOTAL EV Load [kVA]	430	389	1043	942	160

<sup>39</sup> This graph shows PG&E’s specific equipment sizing and is not comparable to other utilities. Calculations are based on estimates from the infrastructure cost model.

<sup>40</sup> For example: Electrical system loading was developed by averaging climatic design data from Climate Zone 3 (Oakland) and 4 (San Jose) to develop a prototype HVAC system:

([https://ww2.energy.ca.gov/maps/renewable/building\\_climate\\_zones.html](https://ww2.energy.ca.gov/maps/renewable/building_climate_zones.html))

<sup>41</sup> <https://www.csemag.com/articles/selecting-sizing-transformers-for-commercial-buildings/>

In the table above, the scenarios that are able to meet the EV reach codes with the existing headroom have been highlighted in green and the one scenario that would be unable to do so is highlighted in red. In most of these cases, the 20% headroom for the secondary transformer afforded significant flexibility to meet the reach codes. Transformers are sized for a worse-case scenario based on the requirements in the electrical code and very seldom operate near capacity. While it may be tempting to oversize a transformer above the typical industry headroom, significant oversizing should be cautioned because it can result in transformer operation significantly out of the normal efficient operation. As shown in Figure 6 below, load factor (percentage of total rated capacity) can have a significant influence on the transformer efficiency. In most times of the day, the transformer is operating at part load and oversizing a transformer can move performance out of the normal operating range and result in inefficient operation. The following figure shows a generalized transformer efficiency curve for a residential distribution transformer sized and highlights where a 20% load point might fall were the transformer pushed to the next size up, typically 40-55% increase in capacity.

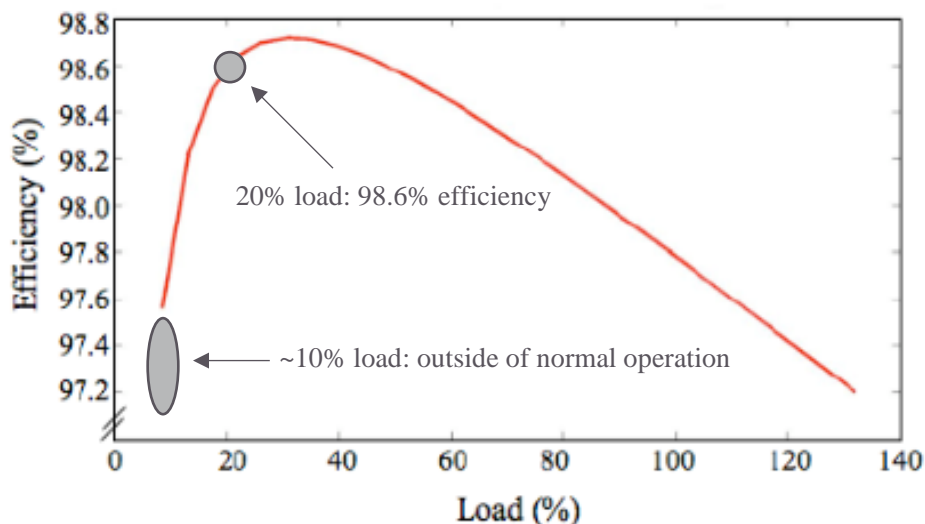


Figure 6: Transformer Efficiency vs. Load Factor<sup>42</sup>

The primary concern around transformers and associated costs pertain to the boundary cases where buildings close to the boundary of (1) needing to host a utility's dedicated primary transformer or (2) will require different utility service (480V instead of 208V) and need to modify their site to provide a secondary transformer. Approximate ranges of which MUDs would need to contend with this are noted in Figure 1 and Figure 5 above. If more capacity is required, it is likely that a combination of solar, energy efficiency measures, or adding battery storage would be able to prevent a transformer upgrades. On the other hand, the interest in electrification of existing gas appliances may compete for the existing capacity.

In the face of all this, load management is a promising option to allow more electric vehicle charging ports without needing to pay for larger infrastructure upgrades. This technology works by managing the amount of

<sup>42</sup>[https://www.researchgate.net/publication/224598589\\_Challenges\\_of\\_PHEV\\_Penetration\\_to\\_the\\_Residential\\_Distribution\\_Network](https://www.researchgate.net/publication/224598589_Challenges_of_PHEV_Penetration_to_the_Residential_Distribution_Network)



throughput to individual charging ports based on what the control system defines for limitations. To date, this feature has primarily been marketed to limit electrical demand charges but could be utilized to prevent overloading panels and/or transformers. Load management for electric vehicles is still nascent technology and would benefit with more developed industry standards. However, the National Electric Code has permitted power management since 2014 but industry may need training to create packaged solutions that can reassure plan checkers and building inspectors.<sup>43</sup>

---

<sup>43</sup> California Electrical Code (Title 24, Part 3): Article 750.30 – Load Management

## Appendix A: Cost Estimates by Type of Expense

The following tables (Table 12 through Table 14) summarize model results for each type of expense per building. All costs below represent **incremental** costs compared to a baseline CALGreen 2019 mandatory building. See Appendix B and Appendix C for more details on the individual tasks included in each of the categories below. The per parking space costs are calculated by dividing the total incremental cost of by the number of added EV capable parking spaces. So for example, for the 60-unit MUD scenario shown below, a CALGreen 2019 mandatory baseline model was created to size the electrical use of a 60-unit MUD apartment building including electrical infrastructure associated with switchgear, panels, and secondary transformer. Under the new construction scenario, the additional 54 EV ports were added to the load and the system resized along with conduits added. For the retrofit scenario, the costs to upsize infrastructure, demolish structures, and provide raceways were added. NOTE: This study does not include costs for EVSE, and does not include and has a overall 20% contingency to account for ADA compliance. ADA can be a significant source of cost and in this study is only intended to capture a limited scope of ADA compliance.

Labor costs generally range from half to two-thirds of total project costs. Labor costs for small buildings with two EV capable parking spaces, based on current CALGreen six percent requirements, were estimated at about four fifths of the total project costs in new construction; however, this may not be representative of other projects for this building type with different site-specific circumstances.

**Table 12. Estimated Incremental Cost of Installing EV Infrastructure: 60-Unit MUD**

Retrofit	60-Unit MUD			
	Market Rate [NC]	Market Rate [Retrofit]	Affordable Housing [NC]	Affordable Housing [Retrofit]
Level 2 Ports Added	9	9	0	0
Level 1 Ports Added	45	45	54	54
Electrical panel	\$15,960	\$26,008	\$9,289	\$13,004
Main electrical room, excluding transformer	\$13,609	\$43,911	\$14,055	\$35,193
Transformer (480V -> 208V)	\$14,164	\$12,743	\$1,081	\$10,897
Raceway / In-slab conduit	\$18,059	\$77,247	\$18,059	\$77,247
Electrical components (wire, receptacle)	\$11,366	\$20,131	\$11,307	\$20,049
Trenching for installation of conduit	\$0	\$0	\$0	\$0
Demolition of equipment	\$0	\$31,940	\$0	\$30,918
Pavings (asphalt & concrete)	\$0	\$7,889	\$0	\$7,889
Permitting & inspection fees	\$2,435	\$15,592	\$2,435	\$15,592
Construction management	\$549	\$4,449	\$403	\$4,264
<b>TOTAL</b>	<b>\$76,142</b>	<b>\$239,909</b>	<b>\$56,629</b>	<b>\$215,051</b>
<b>TOTAL (Price per Port)</b>	<b>\$1,410</b>	<b>\$4,443</b>	<b>\$1,049</b>	<b>\$3,982</b>

Table 13. Estimated Incremental Cost of Installing EV Infrastructure: 150-Unit MUD

Retrofit	150-Unit MUD			
	Market Rate [NC]	Market Rate [Retrofit]	Affordable Housing [NC]	Affordable Housing [Retrofit]
Level 2 Ports Added	23	23	0	0
Level 1 Ports Added	112	112	135	135
Electrical panel	\$59,785	\$83,699	\$44,926	\$62,896
Main electrical room, excluding transformer	\$10,059	\$49,276	\$10,059	\$49,276
Transformer (480V -> 208V)	\$11,539	\$49,742	\$0	\$40,621
Raceway / In-slab conduit	\$45,147	\$193,116	\$45,147	\$193,116
Electrical components (wire, receptacle)	\$28,062	\$49,833	\$28,407	\$50,317
Trenching for installation of conduit	\$0	\$0	\$0	\$0
Demolition of equipment	\$0	\$79,850	\$0	\$77,294
Pavings (asphalt & concrete)	\$0	\$8,442	\$0	\$8,442
Permitting & inspection fees	\$5,798	\$33,069	\$5,798	\$33,069
Construction management	\$1,159	\$6,655	\$964	\$5,196
TOTAL	\$161,550	\$553,682	\$135,301	\$520,227
TOTAL (Price per Port)	\$1,197	\$4,101	\$1,002	\$3,854

Table 14. Estimated Incremental Cost of Installing EV Infrastructure: 60-Space Office

Retrofit	60-Space Office	
	Office [NC]	Office [Retrofit]
Level 2 Ports Added	2	2
Level 1 Ports Added	24	24
Electrical panel	\$5,571	\$13,004
Main electrical room, excluding transformer	\$8,558	\$35,005
Transformer (480V -> 208V)	\$5,748	\$7,786
Raceway / In-slab conduit	\$0	\$0
Electrical components (wire, receptacle)	\$5,285	\$9,031
Trenching for installation of conduit	\$5,133	\$4,562
Demolition of equipment	\$0	\$6,211
Pavings (asphalt & concrete)	\$0	\$6,305
Permitting & inspection fees	\$4,448	\$11,652
Construction management	\$227	\$3,414
TOTAL	\$34,971	\$96,970
TOTAL (Price per Port)	\$1,166	\$3,232

## Appendix B: Permitting and Inspection Costs

Table 15 shows examples of permitting and inspection fees. These fees are not calculated in the model per project but as inputs based on the closest representative level for a project. Table 16 shows the details for these calculations based on the City and County of San Francisco and costs may vary by region.

**Table 15. Examples of Total Permit and Inspection Cost Summary**

# of Circuits	Stand-alone Retrofit			New Construction (Incremental Costs)		
	Fee	Builder Staff Time	Total	Fee	Builder Staff Time	Total
2	\$461	\$650	\$1,111	\$27	\$75	\$102
4	\$1,365	\$850	\$2,215	\$164	\$125	\$289

**Table 16. Electrical and Building Permit and Inspection Cost Data**

Electrical and Building Permit and Inspection Cost Data					
<i>Electrical</i>					
<b>Fees</b>					
\$335	Minimum inspection fee, which covers from 1 to 3 inspections				
\$11	Estimated average application fee per additional circuit beyond minimum				
<b>Builder Time Costs</b>					
New Construction, alterations &	Stand-alone Retrofit				
\$25	\$100	Builder staff time to obtain new permit (inclusive of travel)			
\$25	\$100	Builder staff time per inspection (inclusive of travel)			
\$0	\$150	Electrical engineer staff time for load calculations			
<i>Building</i>					
<b>Fees</b>					
<i>New Construction, alterations, additions</i>		<i>Stand-alone retrofit</i>			
Plan	Permitting	Plan	Permitting		
-	-	\$ 144.85	\$ 62.08	up to \$500	
-	-	\$ 2.93	\$ 1.26	per hundred from \$500 up to \$2000	
-	-	\$ 1.78	\$ 0.76	per hundred from \$2000 up to \$50,000	
\$	0.19	\$	0.10	per hundred from \$5,000,000 to \$50m	
source: San Francisco Fee Table 1A-A <span style="float: right;">note: only costs used in model are listed</span>					
<b>Builder Time Costs</b>					
Incremental Cost, New	Retrofit				
\$25	\$100	Builder staff time to obtain new permit			
\$0	\$100	Builder staff time per inspection (inclusive of travel)			

Notes:

- Fees are calculated based on San Francisco Fee Table 1A-A (building) and Table 1A-E (electrical). New construction fees are based on the incremental cost of adding EV charging infrastructure to a project.
- Two building inspections are assumed for small retrofits, and no additional building inspections are assumed for new construction. One electrical inspection is assumed for adding two circuits and three are assumed for adding 12 circuits.

## Appendix C: Methodology Details

---

This appendix provides additional details on the general assumptions used in the models, data sources for per unit equipment and other costs, and the methods used to determine the quantities needed for each expense type. This appendix does not contain data specific to the scenarios that were modeled, but rather a more general overview of the cost model.

### General Assumptions

- Cost estimates include a fixed general overhead and profit factor.<sup>44</sup>
- Labor costs and equipment costs are based on cost estimates from RSMeans 2019 Q1 and utilize standard union rates.
- RSMeans cost data specified Sacramento, CA with a geographic correction which averaged the RS Means City Cost Index of San Mateo and San Jose.
- In some cases, RS Means contains minimum retrofit task costs.<sup>45</sup> Where related tasks had separate minimum task costs but the labor crew could likely perform more than one related task, the model applied one minimum labor charge.
- Building electrical infrastructure was sized utilizing W/ft<sup>2</sup> engineering calculations for lighting, air conditioning, and other major appliances.
- Building area was estimated using US Census Data
- Common area is assumed for Laundry usage
- Air Conditioner sizing was calculated based on California Climate Zone data for Zone 3 and Zone 4
- California CEUS<sup>46</sup> data is utilized to determine demand for offices

### Data Sources

Estimates of per unit equipment and installation costs were based on retrofit and new construction costs from RS Means, a construction cost reference handbook and online tool for hardware and related installation costs. The City and County of San Francisco rates were used for permit and inspection fee sheets; and the authors estimated costs for contractor labor for permitting, inspections, site inspection, and architectural plans. Cost data from RS Means was for 2018 and was scaled to 2019 using U.S. Bureau of Labor Statistics Producer Price Index statistics. Additional data sources include: feedback from industry experts, engineering estimates, and direct experience to capture different tasks required for the scenarios that were analyzed. This appendix contains a list of all tasks included in the analysis.

---

<sup>44</sup> Individual RS Means line items related to overhead (under General Requirements) are assumed to be addressed by overhead and profit.

<sup>45</sup> Minimum task costs are typically not relevant for new construction due to the overall project scale.

<sup>46</sup> <http://capabilities.itron.com/CeusWeb/ChartsSF/Default2.aspx>

## Soft Costs

### Permit and Inspection Fees

Permitting costs for breaking concrete and electrical permit fees are based on available information from the City and County of San Francisco fees.<sup>47</sup> The total estimated costs include rough and final building and electrical permit fees where applicable. The cost for adding EV capable spaces during construction of a new building is assumed to be relatively low. Builder time spent towards permit filing and inspections is included at \$100 per hour spent on site. Permit and inspection costs can vary between regions.

The model includes a small amount of labor to accommodate permitting and inspection of elements specific to EV capable parking spaces in new construction and alterations and additions, since these activities are already required and minimal additional effort should be needed to add EV capable infrastructure.

Since economies of scale occur with larger quantities, these fees generally scale up with increasing quantities of EV capable infrastructure, though they are not completely scalable. Costs are higher for outdoor circuits than for indoor circuits due to trenching and are higher for retrofits than for new construction or alterations and additions due to demolition, repaving, and repairs.<sup>48</sup>

### ARCHITECTURAL PLAN FEES

Costs to add EV capable parking spaces to architectural plans and drawings will vary between projects based on their overall complexity. They are based on the estimated number of hours for each project and a fee of \$150/hour before geographic adjustments. Costs will also vary if the project is new construction or a retrofit. In the former case, costs will be relatively minor because the architectural firm will likely be familiar with the plan of the building and can easily influence relevant design decisions like adding EV capable infrastructure. For retrofit projects, costs will likely be significantly higher due to the need to investigate and accommodate more complex on-site conditions such as: longer conduit runs, demolition and reconstruction, meeting accessibility requirements based on existing conditions, and/or more limited options for electrical room and panel placement.

A minimal incremental cost is required for adding several EV capable parking spaces to a new building or alteration and addition. In contrast, preparing construction plans for large numbers of EV capable parking spaces to an existing building may take a significant amount of time considering the layout and construction details for each parking space and existing site conditions. Costs will partially scale by the number of EV capable parking spaces.

### LOAD STUDY/SITE CONDITIONS STUDY

Additional expenses are required for stand-alone retrofits at medium or large buildings to assess existing load and other conditions. The load study is necessary to determine the current electrical supply capacity, such as

---

<sup>47</sup> See [Table 1A-A](#) and [Table 1A-E](#)

<sup>48</sup> We note that efforts are underway to streamline permitting and inspections of EV charging infrastructure including EV capable parking spaces.

the transformer and other systems related to the main electrical supply and the current actual load.<sup>49</sup> The study will then determine which on-site upgrades may be needed to install EV capable parking spaces. In addition, site-specific conditions may need to be determined such as current concrete conditions, soils conditions, and/or other conditions. A load study at a facility where other site condition studies aren't needed is assumed to cost \$1,000. Factors such as demolition and/or a greater number of EV parking spaces will drive costs up and a more complex study is assumed to cost \$5,000 in this report (prior to prime contractor expenses). X-ray costs are roughly \$1,000 for a half dozen images, which may be enough for retrofit installations at a medium sized facility, however, more may be required for a 150-space garage.<sup>50</sup> A specific site may require more or less resources depending on actual conditions.

Assuming alterations and additions originally intended for non-EV charging purposes will require an assessment of load and existing conditions, the assessment would also suffice for EV charging as well.

### ELECTRICAL PANEL LOCATIONS AND SIZING

Some electrical panels are located in the main electrical room while others are distributed closer to EV parking spaces to reduce branch circuit lengths and costs. Distributed panels are more practical in locations with convenient wall mounting locations protected from weather and vandalism. All panel and sub-panel conduits are assumed to be installed in 1 ½ inch steel surface-mounted conduits for 225 ampere panels (to carry 250 MCM wire) or 2-inch conduits for 400 ampere panels (to carry 600 MCM wire) to provide a high level of protection and allow for easy visual inspection.

In some cases, a panel installed in new construction can be upsized to serve both base loads (such as garage lighting, elevators, and miscellaneous outlets) and EV charging loads. In other cases, panels for EV charging are sized to their maximum practical size (typically 400 amperes) just to meet EV charging needs. (Panels are generally limited by electrical panel capacity rather than physical size for EV electrical infrastructure. A single-phase 400-ampere panel has electrical capacity for 10 circuits and typically has physical space for 15 40-ampere circuits even if they utilize double slot 20-ampere breakers.)

The type of electrical panels will depend on whether a building is served by three-phase (4-wire) electrical service or one-phase (3-wire) electrical service. Medium and large commercial buildings and multifamily buildings usually receive three-phase service. When a panel receives three phases of electricity instead of one, it can accommodate additional EV capable parking spaces. However, the phases must be “balanced”, which restricts how many additional circuits for EV capable parking spaces can be accommodated. We assumed that three-phase 225 ampere panels can accommodate 9 40-amp circuits and three-phase 400 ampere panels can accommodate 15 40 ampere circuits based on interviews with contractors and an electrical design firm.

---

<sup>49</sup> Transformers are usually sized based on the typical maximum actual load of a building. Unlike electrical panels and electrical circuits, transformers can be under loaded to extend their lifetime of fully loading, or even occasionally overloaded without causing an immediate reliability issue but with potential reduced long-term lifetime.

<sup>50</sup> Concrete X- Ray Imaging, Penhall, <https://www.penhall.com/concrete-x-ray-imaging/> accessed 7-4-2019.

## Construction Management

The model also includes a cost factor to represent additional fixed costs incurred by contractors for retrofit installations prior to project initiation. These costs include contractor time spent traveling to a site for surveying, evaluating existing conditions, estimating project costs, and preparing bids. Costs will vary based on the complexity of the project.<sup>51</sup> For new construction, these costs likely do not apply or require minimal additional effort to address EV capable electrical infrastructure. The construction management category also includes general permit application fees.

## Raceways, Wire, and Termination Point

PVC materials (i.e. plastic) are included for branch circuit conduits installed in new construction of enclosed parking areas and alterations and additions to enclosed parking that remove the parking surface, while wall and ceiling-mounted metal conduit is assumed for stand-alone retrofits. The authors assumed that intermediate metal conduit was installed for any outdoor raceway in trenches to provide corrosion resistance and for any indoor retrofit cases where walls and floors will not be replaced. Additional raceways may be needed between floors and inaccessible areas.

1¼-inch raceways are generally assumed to carry up to twelve #8 wires rated at 40 amperes (three per circuit) to support 30-ampere EVSE, with the potential to add wiring for a fifth circuit where convenient.<sup>52,53</sup> Some additional raceways are also needed to serve individual termination locations (i.e. a main conduit run carrying four wires may end at one receptacle pair and a local distribution conduit would carry the other pair to its termination point). These short distribution raceways were also sized at one and a quarter inches for simplicity; though they could be sized at one inch or below, we do not expect that this difference would be significant. In some cases, raceways installed in-slab during new construction will accommodate more and/or higher capacity wires than retrofits that are wall mounted and encounter additional bends at corners and obstacles, limiting their capacity. These potential cost savings are site-specific and not included in the model. Wire is not included for branch circuits for EV capable parking spaces. Wires for any distributed panels that are noted in the scenario summary table are included in the costs.

The length of raceways within a given floor for enclosed parking at new construction and repaving are calculated based on direct routes from the electrical panel to the termination point since no obstacles are present during new construction. Retrofitting surface-mounted conduit is generally assumed to be twice as long in new construction because they must follow walls and ceilings with less direct routing. Compared to new construction, raceway distances are increased by 125 percent for gut rehabilitation because significant

---

<sup>51</sup> This estimate assumes that contractors win some of their bids for retrofit projects. The success rate will vary based on specific circumstances. For instance, a sole source contracting mechanism would result in a higher success rate while a contracting mechanism requiring three or more bids would result in a lower success rate. Actual costs will vary from project to project.

<sup>52</sup> Because EV charging is considered a continuous load, the circuit capacity must be at least 25 percent higher than the end load.

<sup>53</sup> We note that higher capacity #6 wire could also be installed at a rate of four sets per 1 ¼ inch conduit without larger sized conduit, unless conduit capacity is limited due to bends that restrict fill rates. For an example of allowable fill rates, see Elliot Electric Supply "Conduit Fill Table" at [https://www.elliotelectric.com/StaticPages/ElectricalReferences/ElectricalTables/Conduit\\_Fill\\_Table.aspx](https://www.elliotelectric.com/StaticPages/ElectricalReferences/ElectricalTables/Conduit_Fill_Table.aspx).



portions of the building are removed while some obstructions may remain. Raceway distances are also increased by 150 percent for stand-alone retrofits in outdoor trenches to account for indirect routing (i.e. avoiding existing infrastructure). Surface mounted retrofit distances are increased by 200 percent, compared to new construction, due to the long distances to follow existing walls and to account for routing around existing obstacles.

Actual configurations can vary based on site-specific circumstances. For instance, if several EV parking spaces are located a significant distance from the main electrical panel, a single (larger) raceway run to an additional electrical panel closer to EV parking spaces can be installed with raceways branching from the panel to the planned EVSE location. This configuration would most likely save costs in buildings where the reduced length of raceways would exceed additional electric panel costs. Raceways for electrical panels outside of the main electrical room are sized (at ½ inch intervals, i.e. 1 ½ inch or 2 inches) based on the wire needed to serve that panel.

Conduits will generally terminate at a receptacle with an outlet box with a face plate and no EVSE (i.e. the unit that connects to the vehicle) installed at the time of construction. Local municipal building codes can also require a specific type of receptacle, which does not have a large impact on the cost-effectiveness of code. Receptacles are assumed to be installed in pairs to serve parking spaces on either side of the pair.

No additional curbs or bollards are assumed at the termination point. Local jurisdictions may wish to include a requirement for anchor points for EVSE near the termination point if the EVSE can be wall-mounted, which should not significantly affect the cost of EV capable building codes.

## Demolition, Reconstruction, and Repaving

The model contains several job types related to demolition, construction, and repaving for stand-alone projects and projects where parking areas and/or electrical rooms are undergoing renovations that would allow installation of this equipment without any further demolition and reconstruction.

For both enclosed and surface parking, demolition for electrical rooms includes cutting and/or drilling, breaking large pieces into smaller pieces, minimum equipment/labor costs, loading and disposal. Reconstruction costs include concrete work (cost for pouring slabs is used as a proxy), reinforcing rods, forms, and minimum labor charges.

Demolition for parking areas include cutting a three-foot-wide section of pavement to allow two-foot-wide trenches; backhoe rental to trench, mobilization and operation, and disposal of materials. Some trenching would also be required for adding EV capable parking spaces in new construction, when repaving existing parking or adding parking. In these cases, costs would likely be much lower due to the presence of trenching equipment on-site to meet other project needs unrelated to EV capable parking spaces.

## Contingencies

A 20 percent contingency was applied for stand-alone retrofit projects based on RS Means. Contingencies are necessary because specific challenges may not be visible at the start of a stand-alone retrofit project or because existing conditions may be difficult to alter without expanding the scope and cost of a retrofit project - for instance if an electrical room lacks space for additional panel(s) or was originally constructed far from parking spaces. A general contingency was not added for EV capable parking spaces installed as part of a

larger retrofit project such as resurfacing or building new parking spaces at an existing site because the conditions will more closely resemble new construction, given their broader scope. In addition, specific cost increases were already included to address higher costs for alterations and additions compared to new construction, such as conservatively assuming that additional parking spaces would be located further from electrical power than existing spaces.

On top of this, another 20 percent contingency was applied to estimate potential costs for accessibility (ADA) compliance associated with restriping, adjusting path of travel, vertical clearances, and slope modifications. ADA compliance costs can be significant but are not the focus of this report.

## Transformers

Transformer costs related to secondary or “step down” transformers have been incorporated into this cost model. Only the wiring costs are considered, not the additional costs for a concrete pad, or disposal of the previous transformer. As mentioned previously, these transformers are used to “step down” 480 V service to 208/240 V for buildings connected to 480 V power, which in PG&E’s service area consist of buildings in the 300kVA and up range. CARB has found that EV charging generally represents a relatively small fraction of overall building power demand in multifamily housing with 10% EV Capable parking spaces. These transformer upgrades are often not necessary to support EV charging infrastructure for buildings but may be more likely with the higher EV infrastructure requirements such as those considered in this report.

An electrical engineering firm and several contractors were consulted with and confirmed that they have found that levels of EV capable parking spaces proposed for CALGreen typically would not require a transformer upgrade, noting the typical headroom of 20% is usually sufficient to cover this growth. It was noted that in some cases, a potential off-site utility infrastructure upgrade could be required, as noted in the Primary Transformers section above.

In the case that EV infrastructure would trigger an expensive switchgear or transformer upgrade it should be investigated whether retrofits that include more energy-efficient lighting and other equipment meeting current mandatory California, ENERGY STAR®, and/or federal standards.

We expect that in cases where a transformer upgrade would be required to install EV capable infrastructure, building codes requiring EV capable parking spaces and associated electrical capacity could achieve significant cost savings related to these costs. Stand-alone transformer retrofits could require replacing conduits serving the transformer, replacing the transformer pad or adding a new pad, and adding an additional transformer or upgrading an existing transformer. By comparison, designing the electrical room for adequate capacity would allow the installation of larger sized conduits and/or transformer pads during initial construction at minimal cost. While we have not quantified all of these costs, the incremental cost of installing a 3” conduit instead of a 2” conduit would be very small compared to breaking existing concrete to install a larger sized conduit later.

## Task Descriptions

Task descriptions for each scenario are listed below in Table 17. The table lists tasks with a note to designate where the task applies to retrofits, new construction, or both. A negative number indicates the avoidance of smaller electrical panel(s) due to installation of a larger panel. (Tasks that are listed with a “0” quantity were included as an option in detailed calculations used to determine project task descriptions, but the detailed design calculations resulted in a zero quantity for the specific task).

**Table 17.** Task Descriptions and Quantities

Task Description	Construction Type	Work Type	Unit	60-unit MUD			150-unit MUD			Medium Office	
				CALGreen	Market Rate	Affordable Housing	CalGreen	Market Rate	Affordable Housing	CalGreen	10% L2 40% L1
				Quantity for Each Scenario							
Rent core drill, electric, 2.5 H.P. 1" to 8" bit diameter, includes hourly operating cost	retro	demo	ea.		8	10		20	25		4
Rent mixer power mortar & concrete gas 6 CF, 18 HP, one day including 4 hours operating cost	retro	demo	Ea.		2	2		5	5		
Rent backhoe-loader 40 to 45 HP 5/8 CY capacity, one day including 4 hours operating cost	retro	demo	per day								3
Selective demolition, rubbish handling, dumpster, 6 C.Y., 2 ton capacity, weekly rental, includes one dump per week, cost to be added to demolition cost.	retro	demo	Week		2	2		5	5		0
Deconstruction of concrete, floors, concrete slab on grade, plain, 4" thick, up to 2 stories, excludes handling, packaging or disposal costs	retro	demo	S.F.		24	30		60	75		
Selective concrete demolition, reinforce less than 1% of cross-sectional area, break up into small pieces, excludes shoring, bracing, saw or torch cutting, loading, hauling, dumping	retro	demo	C.Y.		8	10		20	25		5
Selective concrete demolition, minimum labor/equipment charge	retro	demo	Job		2	2		5	5		
Concrete sawing, concrete slabs, rod reinforced, up to 3" deep	retro	demo	L.F.		24	30		60	75		16
Concrete sawing, concrete, existing slab, rod reinforced, for each additional inch of depth over 3"	retro	demo	L.F.		24	30		60	75		16
Selective demolition, concrete slab cutting/sawing, minimum labor/equipment charge	retro	demo	Job		2	2		5	5		1
Concrete core drilling, core, reinforced concrete slab, 2" diameter, up to 6" thick slab, includes bit, layout and set up	retro	demo	Ea.		60	60		150	150		
Receptacle devices, residential, duplex outlet, ivory, EMT & wire, 20', 15 amp, incl box & cover plate	new	electric	Ea.		27	23		68	56		12

ATTACHMENT 8

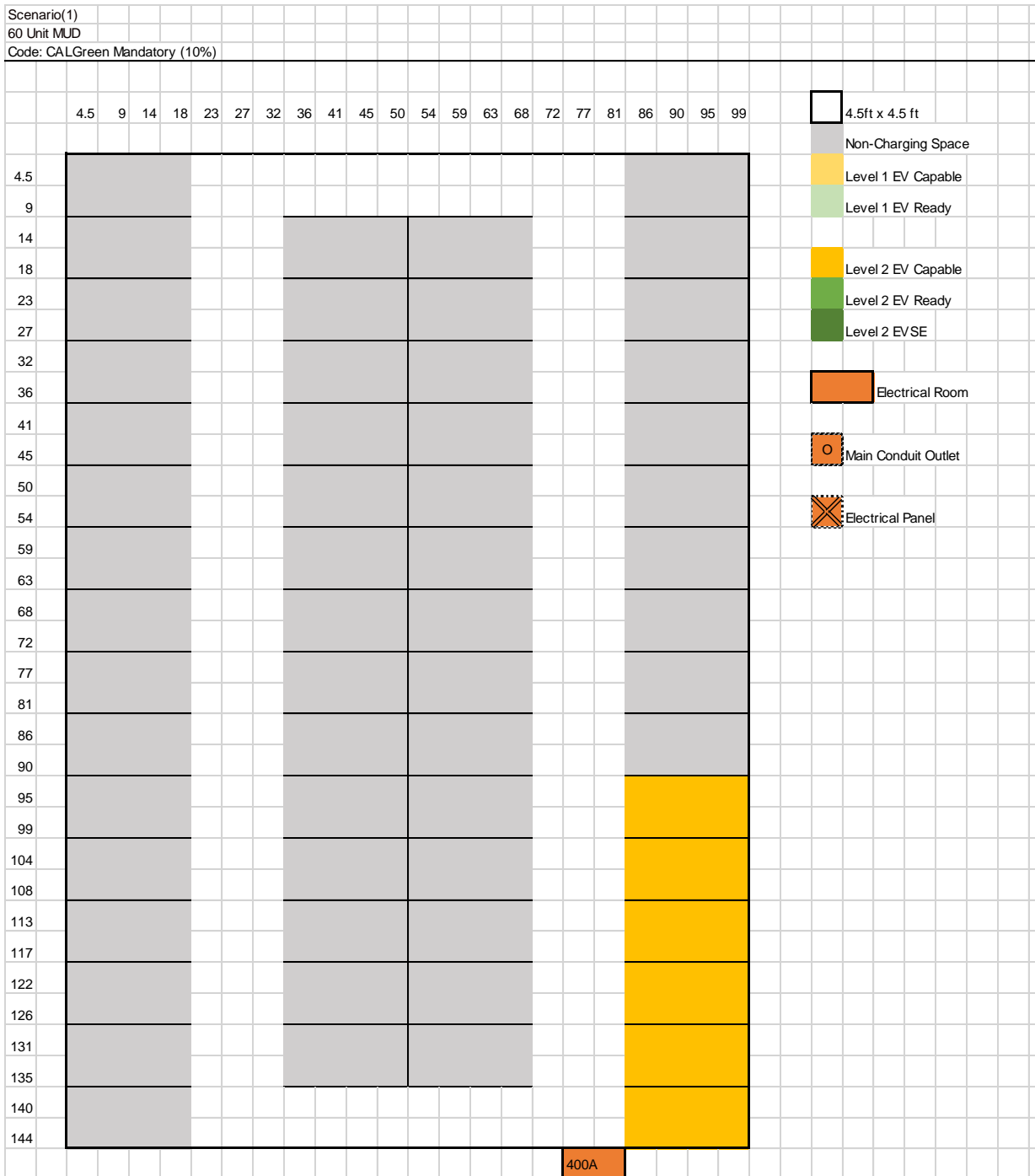
Task Description	Construction Type	Work Type	Unit	60-unit MUD			150-unit MUD			Medium Office	
				CALGreen	Market Rate	Affordable Housing	CalGreen	Market Rate	Affordable Housing	CalGreen	10% L2 40% L1
				Quantity for Each Scenario							
Receptacle, range, 50 Amp	retro	electric	Ea.		6	15		15	38		6
Receptacle devices, residential, duplex outlet, ivory, EMT & wire, 20', 15 amp, incl box & cover plate	retro	electric	Ea.		27	23		68	56		12
permitting & inspection, 2 internal circuits, excludes general building permit fees	new	fee	per job								
permitting & inspection, 4 internal and 2 external circuits, excludes general building permit fees	new	fee	per job							1	5
permitting & inspection, 4 internal circuits, excludes general building permit fees	new	fee	per job	1							
permitting & inspection, 14 internal circuits, excludes general building permit fees	new	fee	per job		1	1	1	1	1	1	1
permitting, per internal circuit over 4, excluding general building permit fees	new	fee	per circuit	2	20	20	1	60	60	2	
permitting & inspection, 14 internal and 7 external circuits, excludes general building permit fees	retro	fee	per job				1	1	1		
permitting & inspection, 14 internal circuits, excludes general building permit fees	retro	fee	per job		1	1					1
permitting, per internal circuit over 4, excluding general building permit fees	retro	fee	per circuit		20	20		60	60		20
architectural plans/drawings	retro	fee	per hour	8	14	14	14	38	38	6	9
architectural plans/drawings	new	fee	per hour	2	4	4	4	12	12	2	3
site and load study	retro	fee	per \$1000	1	3	3	3	5	5	1	2
Circuit Breakers - 480V 3-pole, 70 to 225Amp	new	main	Ea.	1	-1	-1					
Circuit Breakers - 480V 3-pole, 70 to 225Amp	retro	main	Ea.	1							
Switchboard - 3-pole, 4-wire, 400 Amp	retro	main	Ea.	1						1	
Circuit Breakers - 480V 3-pole, 450 to 600 Amp	retro	main	Ea.		1		1				
Circuit Breakers - 480V 3-pole, 700 to 800 Amp	new	main	Ea.			1					
Circuit Breakers - 480V 3-pole, 700 to 800 Amp	retro	main	Ea.			1					
Circuit Breakers - 480V 3-pole, 125 to 400Amp	new	main	Ea.								1
Circuit Breakers - 480V 3-pole, 125 to 400Amp	retro	main	Ea.								1
Circuit Breakers - 480V 3-pole, 15 - 60 Amp	retro	main	Ea.							1	
Distribution Switchboard Enclosure - 4 wire, 1000 Amp	new	main	Ea.					1	1		
Distribution Switchboard Enclosure - 4 wire, 1000 Amp	retro	main	Ea.					1	1		
Incoming Switchboards - 277/480V, 4 wire, 800 Amp	retro	main	Ea.			1					1
Incoming Switchboards - 277/480V, 4 wire, 800 Amp (w/ Fused Switch & CT Compartment)	new	main	Ea.					1	1		

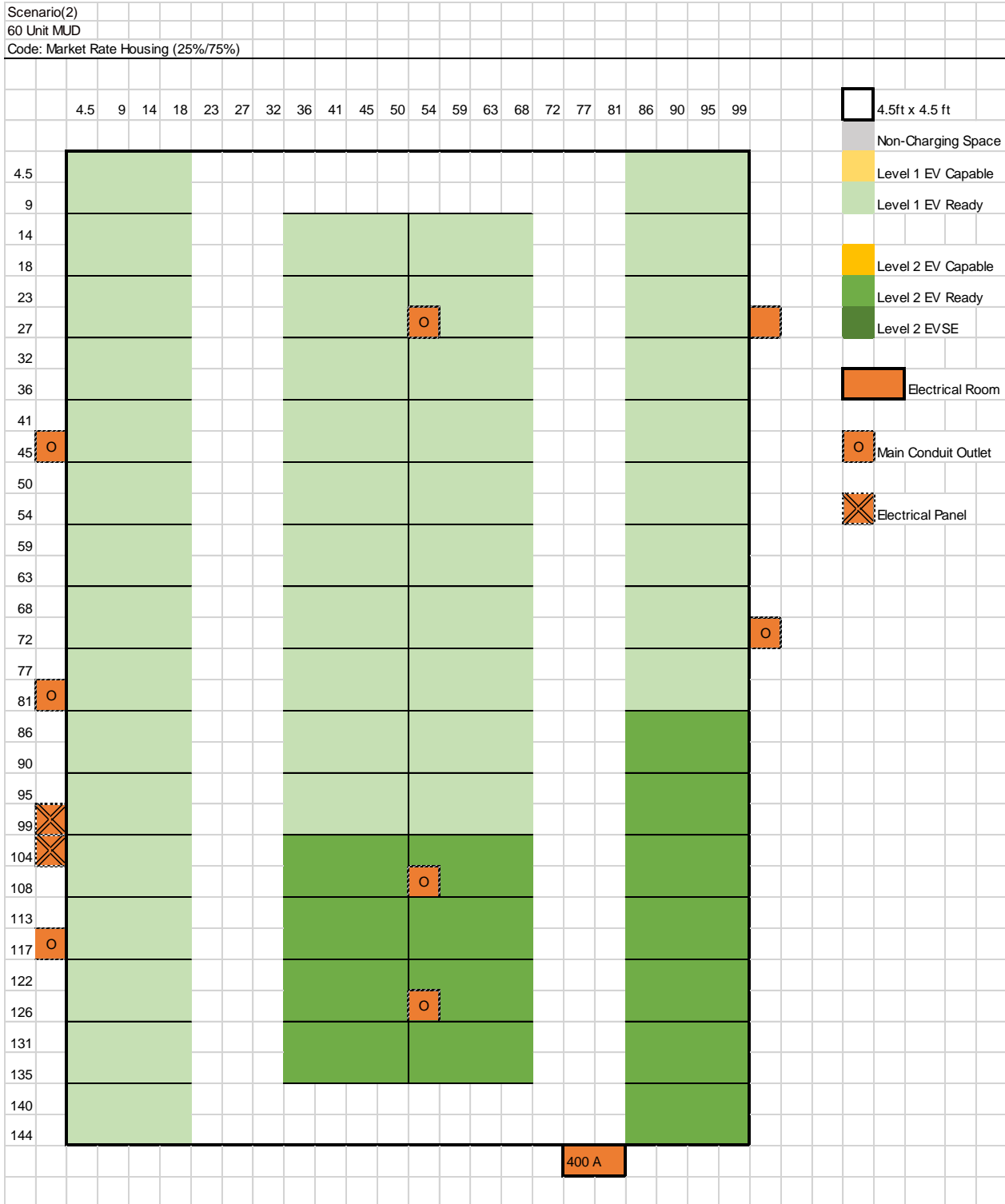
Task Description	Construction Type	Work Type	Unit	60-unit MUD			150-unit MUD			Medium Office	
				CALGreen	Market Rate	Affordable Housing	CalGreen	Market Rate	Affordable Housing	CalGreen	10% L2 40% L1
				Quantity for Each Scenario							
Incoming Switchboards - 277/480V, 4 wire, 800 Amp (w/ Fused Switch & CT Compartment)	retro	main	Ea.					1	1		
Switchboard - 3-pole, 4-wire, 2000 Amp	new	main	Ea.					1	1		
Switchboard - 3-pole, 4-wire, 2000 Amp	retro	main	Ea.					1	1		
Switchboard - 3-pole, 4-wire, 600 Amp	retro	main	Ea.		1		1				
Switchboard - 3-pole, 4-wire, 800 Amp	new	main	Ea.			1					1
Switchboard - 3-pole, 4-wire, 800 Amp	retro	main	Ea.			1					1
Panelboards, 1 phase 3 wire, main circuit breaker, 120/240 V, 225 amp, 30 circuits, NQOD, incl 20 A 1 pole bolt-on breakers	new	panel						1		1	-1
Panelboards, 1 phase 3 wire, main circuit breaker, 120/240 V, 225 amp, 30 circuits, NQOD, incl 20 A 1 pole bolt-on breakers	retro	panel						1			
Panelboards, 1 phase 3 wire, main circuit breaker, 120/240 V, 400 amp, 30 circuits, NQOD, incl 20 A 1 pole bolt-on breakers	new	panel		1	1	-1			1		
Panelboards, 1 phase 3 wire, main circuit breaker, 120/240 V, 400 amp, 30 circuits, NQOD, incl 20 A 1 pole bolt-on breakers	retro	panel			1	2			1		1
Reinforcing steel, in place, dowels, smooth, 12" long, 1/4" or 3/8" diameter, A615, grade 60	retro	pave	Ea.		90	90		72	72		48
Structural concrete, in place, slab on grade (3000 psi), 4" thick, includes concrete (Portland cement Type I), placing and textured finish, excludes forms and reinforcing	retro	pave	S.F.		30	30		24	24		16
Structural concrete, in place, minimum labor/equipment charge	retro	pave	Job		1	1		1	1		1
PVC conduit, schedule 40, 1-1/4" diameter, in concrete slab, includes terminations, fittings and supports	new	race	L.F.	324	2147	2147	1080	5366	5366		
LV Transformer, Dry Type - 480V primary, 120/208V secondary (112.5 kVA)	retro	trans	Ea.		1						
LV Transformer, Dry Type - 480V primary, 120/208V secondary (75 kVA)	Retro	trans	Ea.								1
LV Transformer, Dry Type - 480V primary, 120/208V secondary (150 kVA)	Retro	trans	Ea.			1				1	
LV Transformer, Dry Type - 480V primary, 120/208V secondary (225kVA)	Retro	trans	Ea.	1							
LV Transformer, Dry Type - 480V primary, 120/208V secondary (300 kVA)	New	trans	Ea.		1						
LV Transformer, Dry Type - 480V primary, 120/208V secondary (500 kVA)	New	trans	Ea.			1					

Task Description	Construction Type	Work Type	Unit	60-unit MUD			150-unit MUD			Medium Office	
				CALGreen	Market Rate	Affordable Housing	CalGreen	Market Rate	Affordable Housing	CalGreen	10% L2 40% L1
				Quantity for Each Scenario							
LV Transformer, Dry Type - 480V primary, 120/208V secondary (500 kVA)	Retro	trans	Ea.					1			
LV Transformer, Dry Type - 480V primary, 120/208V secondary (750 kVA)	Retro	trans	Ea.				2		1		

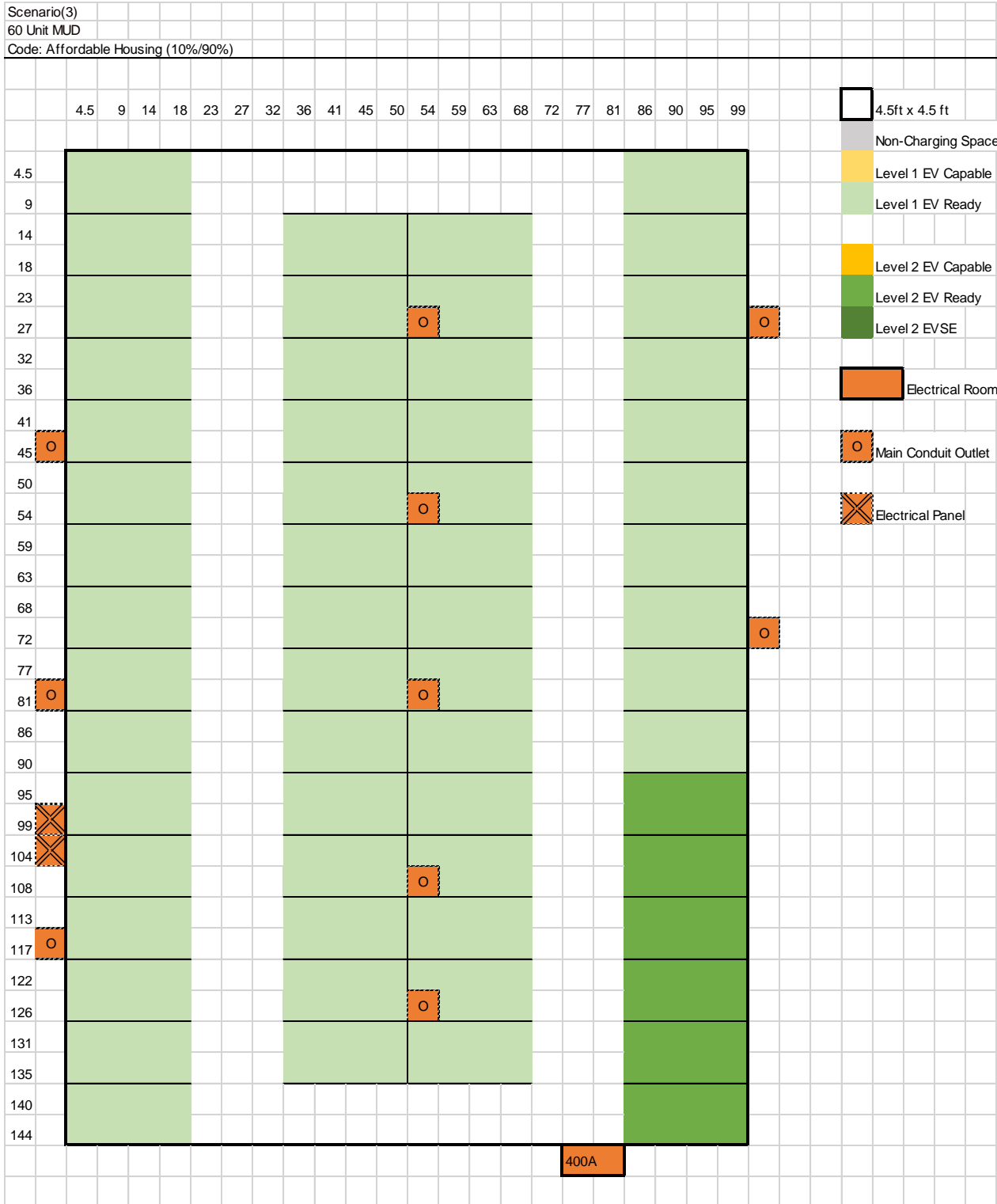
# Appendix D: EV Capable Installation Configurations

This section includes figures to generally depict the configuration of each scenario that was analyzed. They are not intended to include all details of a particular installation nor are they intended to represent any particular specific installation.

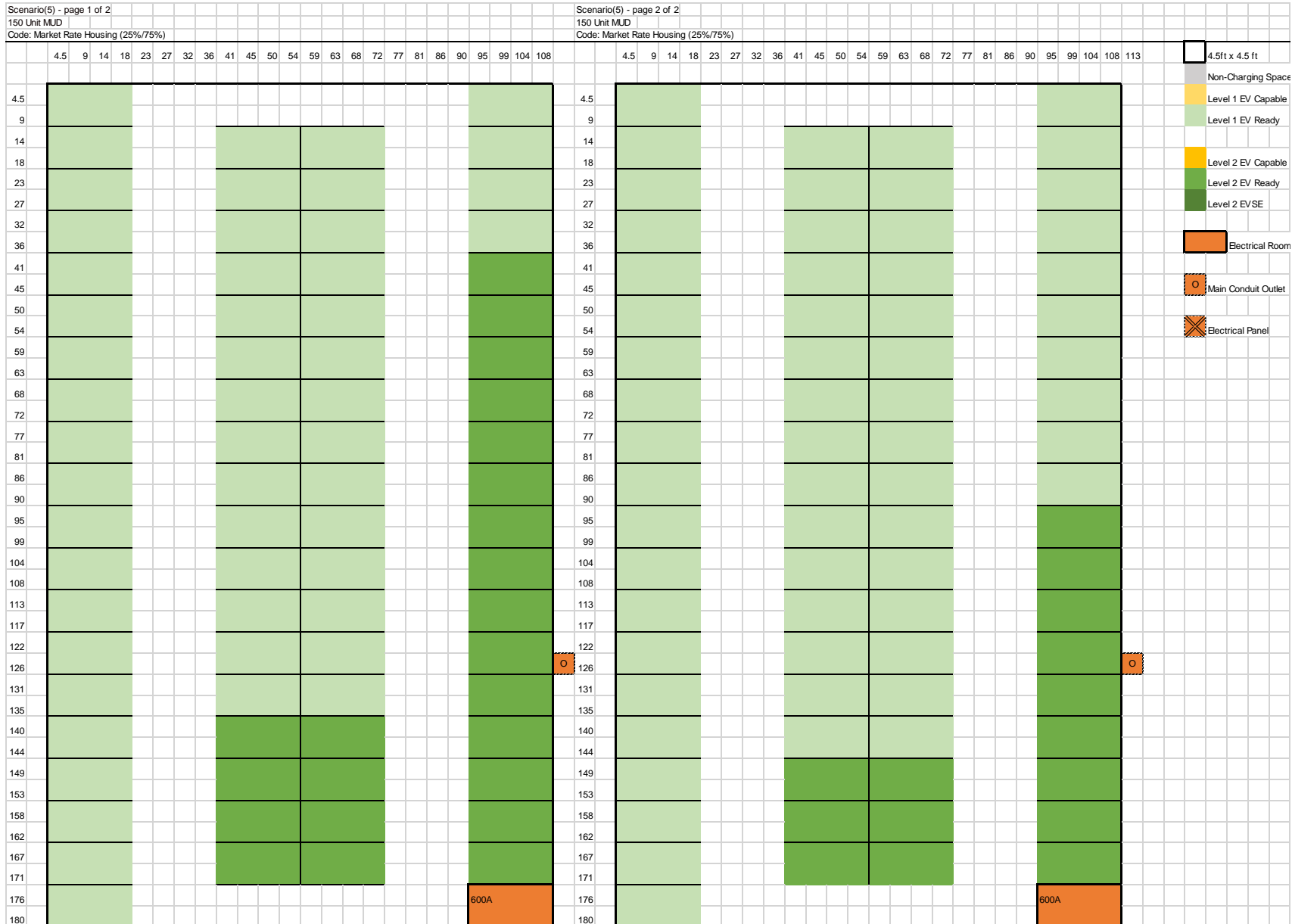












Scenario(6) - page 1 of 2

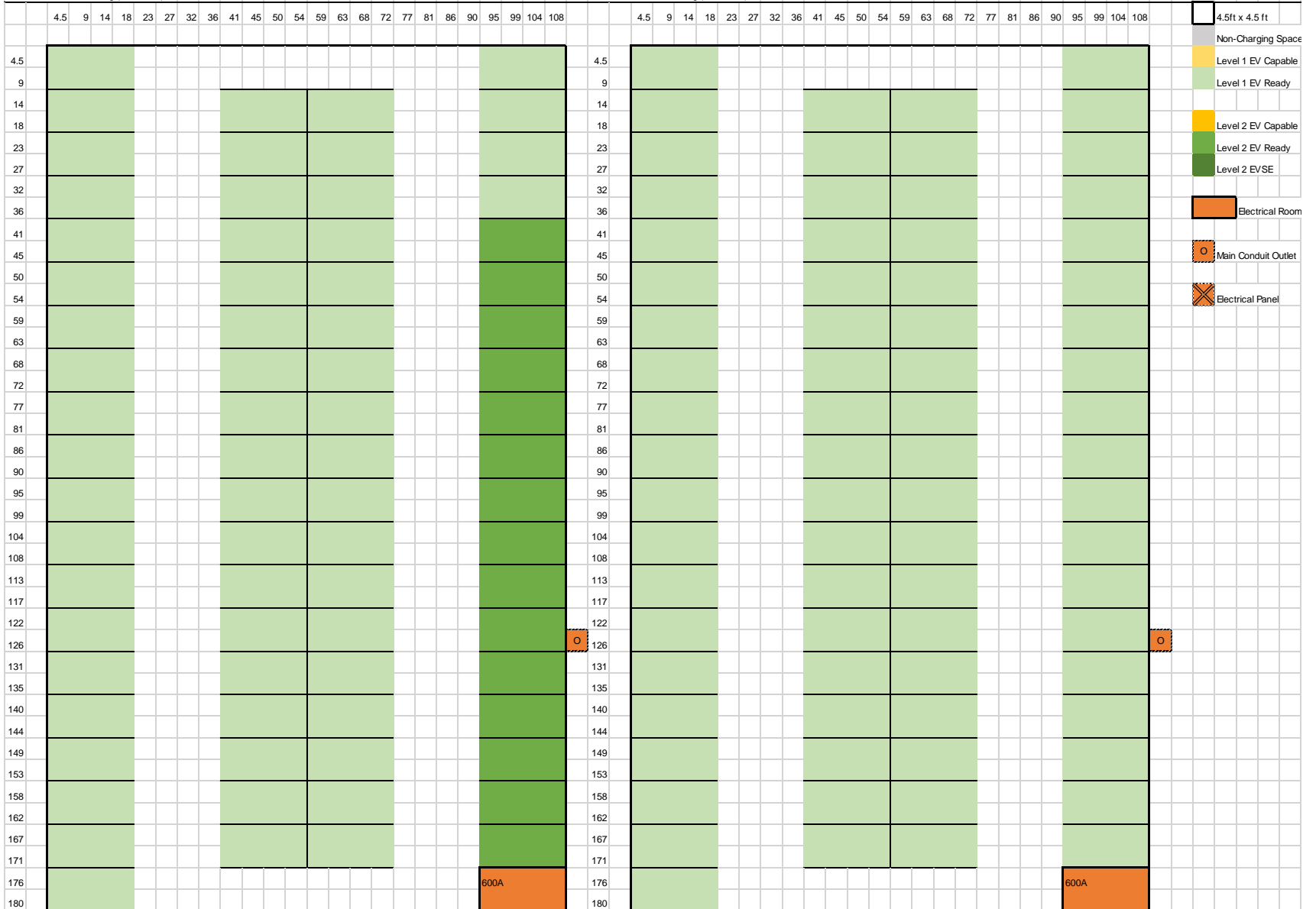
150 Unit MUD

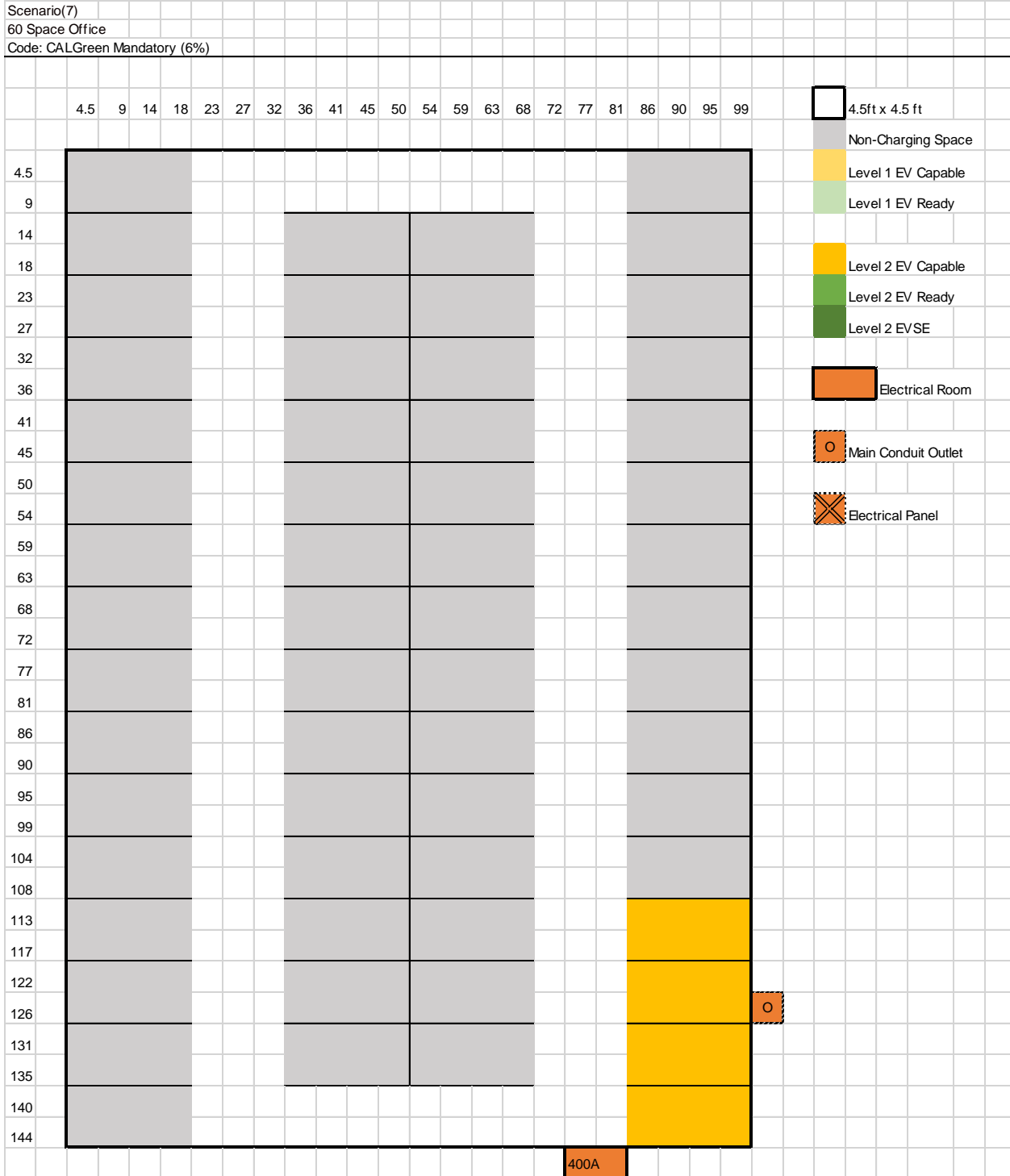
Code: Affordable Housing (10%/90%)

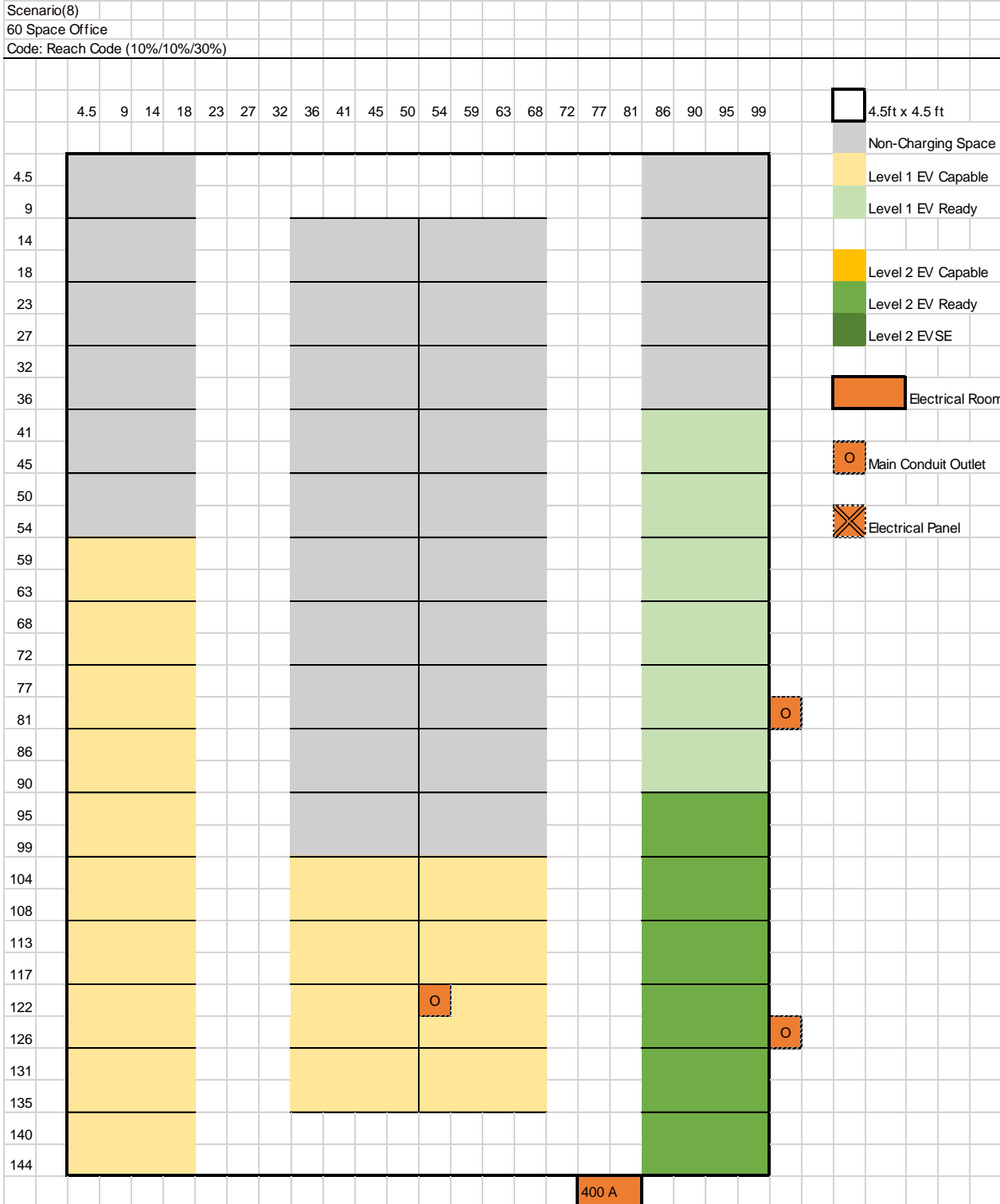
Scenario(6) - page 2 of 2

150 Unit MUD

Code: Affordable Housing (10%/90%)









# SIERRA CLUB

## LOMA PRIETA CHAPTER

SAN MATEO, SANTA CLARA & SAN BENITO COUNTIES

October 27, 2020

Los Altos City Council  
1 North San Antonio Road  
Los Altos, CA 94022  
Via email to: [council@losaltosca.gov](mailto:council@losaltosca.gov)

RE: 10.27.2020 City Council Agenda Item 7: Reach Codes

Dear Los Altos City Councilmembers,

We are living in a climate crisis that poses an existential threat to the survival of organized human life and global biodiversity. The scientific consensus on climate change tells us that our society must rapidly transition away from fossil fuels. The Sierra Club Loma Prieta Chapter is pleased that the Los Altos City Council will consider the adoption of Reach Codes tonight. It is imperative that we no longer continue to build more unnecessary fossil fuel pipelines that are a cost, health, and climate hazard to our community and to future generations.

The Loma Prieta Chapter would like to thank all of the City Councilmembers and City Staff who have worked hard to bring the code before us in its current form. **While we hope that Los Altos will adopt a fully all-electric code in the near future, we also believe it is imperative that the City move forward tonight with the Reach Code as presented in the staff report.**

We hope you take this important step to help the community transition away from fossil fuels and towards a future that is healthy for our residents and ecosystems.

Sincerely,



Dashiell Leeds, Conservation Assistant, Sierra Club Loma Prieta Chapter

Cc: James Eggers, Executive Director, Sierra Club Loma Prieta Chapter